

# G3VM-601BY/EY

MOS FET Relays

## Analog-switching MOS FET Relays with a Dielectric Strength of 5 kVAC between I/O Using Optical Isolation.



- Switches minute analog signals.
- Switching AC and DC.
- Peak load voltage of 600 V.
- Dielectric strength of 5 kVAC between I/O.

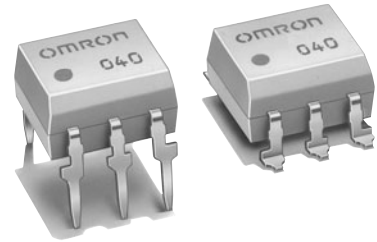

Note: The actual product is marked differently from the image shown here.

RoHS compliant

### Application Examples

- Communication equipment
- Test & Measurement equipment
- Industrial equipment
- Security equipment

### Terminal Arrangement/Internal Connections

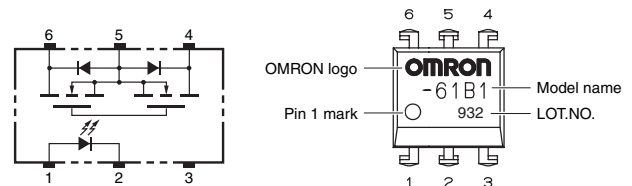

Note: The actual product is marked differently from the image shown here.

### List of Models

Package type	Contact form	Terminals	Load voltage (peak value) *	Model	Minimum package quantity	
					Number per tube	Number per tape and reel
DIP6	1a (SPST-NO)	PCB Terminals	600 V	G3VM-601BY	50	-
		Surface-mounting Terminals		G3VM-601EY		
				G3VM-601EY (TR)	-	1,500

\* The AC peak and DC value are given for the load voltage.

### Absolute Maximum Ratings (Ta = 25°C)

Item	Symbol	Rating	Unit	Measurement conditions	
Input	LED forward current	IF	50	mA	
	Repetitive peak LED forward current	IFP	1	A	
	LED forward current reduction rate	$\Delta I_F / ^\circ C$	-0.5	mA/ $^\circ C$	
	LED reverse voltage	VR	5	V	
Connection temperature	TJ	125	$^\circ C$		
Output	Load voltage (AC peak/DC)	V <sub>OFF</sub>	600	V	
	Continuous load current	Connection A	100	mA	Connection A: AC peak/DC Connection B and C: DC
		Connection B	100		
		Connection C	200		
	ON current reduction rate	Connection A	-1.0	mA/ $^\circ C$	Ta $\geq 25^\circ C$
		Connection B	-1.0		
Connection C		-2.0			
Connection temperature	TJ	125	$^\circ C$		
Dielectric strength between I/O (See note 1.)	V <sub>I-O</sub>	5000	V <sub>rms</sub>	AC for 1 min	
Ambient operating temperature	Ta	-40 to +85	$^\circ C$	With no icing or condensation	
Ambient storage temperature	T <sub>stg</sub>	-55 to +125	$^\circ C$	With no icing or condensation	
Soldering temperature	-	260	$^\circ C$	10 s	

Note: 1. The dielectric strength between the input and output was checked by applying voltage between all pins as a group on the LED side and all pins as a group on the light-receiving side.

#### Connection Diagram

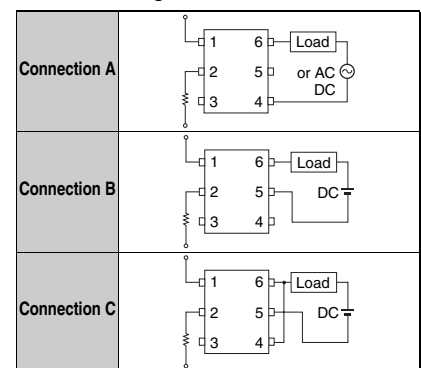

### Electrical Characteristics (Ta = 25°C)

Item	Symbol	Minimum	Typical	Maximum	Unit	Measurement conditions	
Input	LED forward voltage	V <sub>F</sub>	1.0	1.15	1.3	V	
	Reverse current	I <sub>R</sub>	-	-	10	$\mu A$	
	Capacity between terminals	C <sub>T</sub>	-	30	-	pF	
	Trigger LED forward current	I <sub>FT</sub>	-	1.6	5	mA	
Output	Maximum resistance with output ON	R <sub>ON</sub>	Connection A	-	25	35	$\Omega$
			Connection B	-	30	45	$\Omega$
			Connection C	-	23	35	$\Omega$
			Connection C	-	12	18	$\Omega$
	Current leakage when the relay is open	I <sub>LEAK</sub>	-	-	1.0	$\mu A$	
Capacity between terminals	C <sub>OFF</sub>	-	120	-	pF		
Capacity between I/O terminals	C <sub>I-O</sub>	-	0.8	-	pF		
Insulation resistance between I/O terminals	R <sub>I-O</sub>	1000	-	-	M $\Omega$		
Turn-ON time	t <sub>ON</sub>	-	0.2	1.5	ms		
Turn-OFF time	t <sub>OFF</sub>	-	0.2	1.0	ms		

Note: 2. Turn-ON and Turn-OFF Times

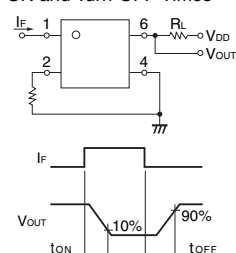

## Recommended Operating Conditions

Use the G3VM under the following conditions so that the Relay will operate properly.

Item	Symbol	Minimum	Typical	Maximum	Unit
Load voltage (AC peak/DC)	V <sub>DD</sub>	-	-	480	V
Operating LED forward current	I <sub>F</sub>	7.5	15	25	mA
Continuous load current (AC peak/DC)	I <sub>O</sub>	-	-	100	mA
Ambient operating temperature	T <sub>a</sub>	-20	-	65	°C

## Engineering Data

LED forward current vs. Ambient temperature

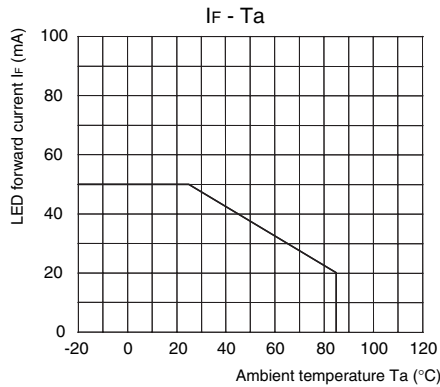

Continuous load current vs. Ambient temperature

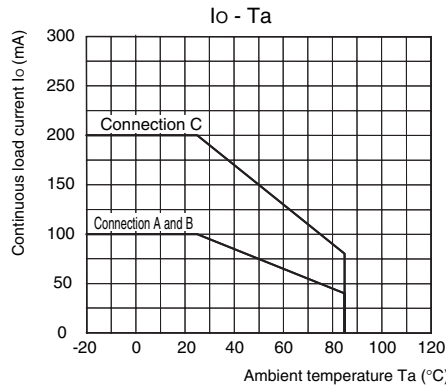

LED forward current vs. LED forward voltage

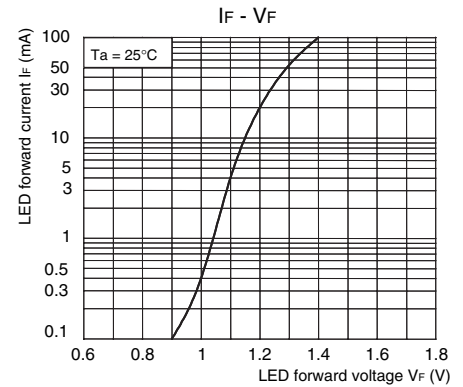

Continuous load current vs. On-state voltage

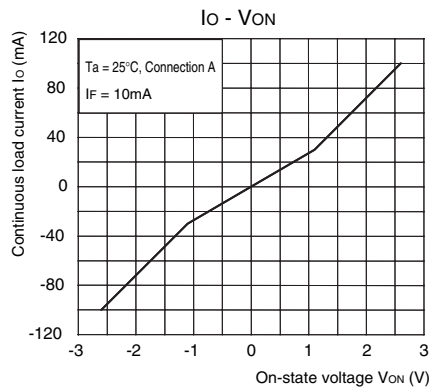

On-state resistance vs. Ambient temperature

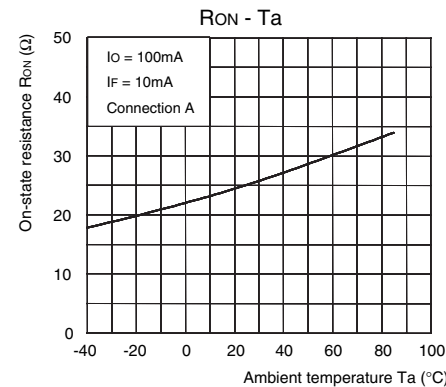

Trigger LED forward current vs. Ambient temperature

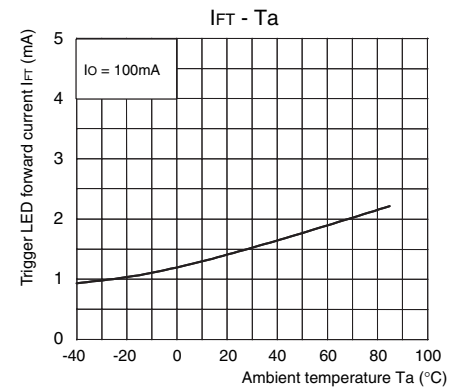

Turn ON, Turn OFF time vs. LED forward current

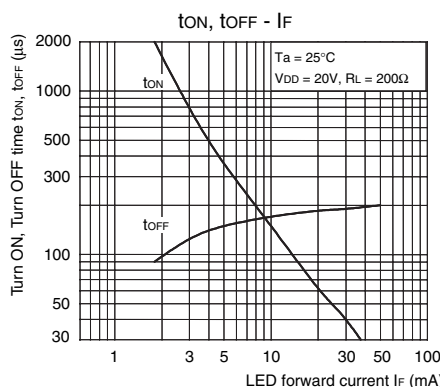

Turn ON, Turn OFF time vs. Ambient temperature

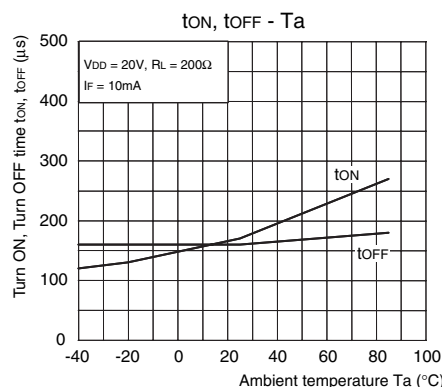

Current leakage vs. Ambient temperature

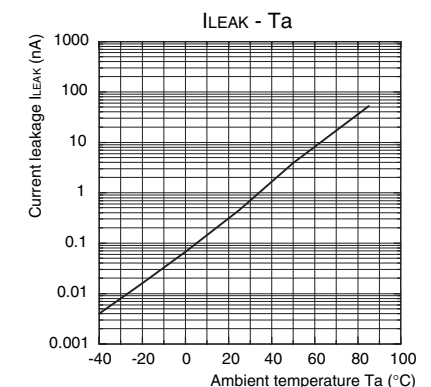

## Safety Precautions

- Refer to "Common Precautions" for all G3VM models.

## ■ Appearance

### DIP (Dual Inline Package)

DIP6

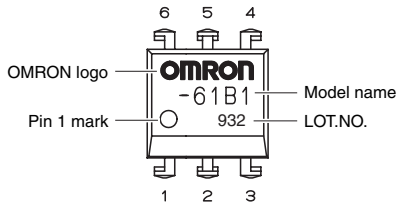

Note: The actual product is marked differently from the image shown here.

## ■ Dimensions

(Unit:mm)

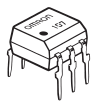

### PCB Terminals

Weight: 0.4 g

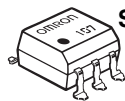
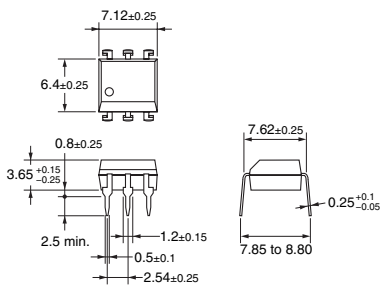

### Surface-mounting Terminals

Weight: 0.4 g

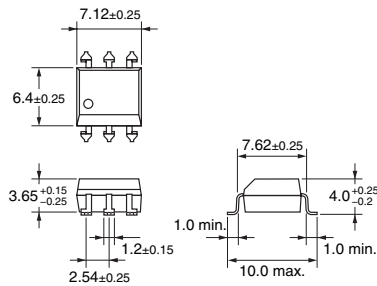

### PCB Dimensions (BOTTOM VIEW)

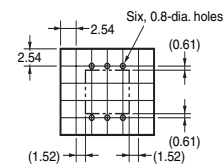

### Actual Mounting Pad Dimensions

(Recommended Value, TOP VIEW)

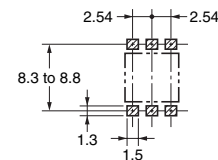

Note: The actual product is marked differently from the image shown here.

- Application examples provided in this document are for reference only. In actual applications, confirm equipment functions and safety before using the product.
- Consult your OMRON representative before using the product under conditions which are not described in the manual or applying the product to nuclear control systems, railroad systems, aviation systems, vehicles, combustion systems, medical equipment, amusement machines, safety equipment, and other systems or equipment that may have a serious influence on lives and property if used improperly. Make sure that the ratings and performance characteristics of the product provide a margin of safety for the system or equipment, and be sure to provide the system or equipment with double safety mechanisms.

Note: Do not use this document to operate the Unit.

**OMRON Corporation**

ELECTRONIC AND MECHANICAL COMPONENTS COMPANY

Contact: [www.omron.com/ecb](http://www.omron.com/ecb)

Cat. No. **K231-E1-01**  
0412(0412)(O)

Компания «Life Electronics» занимается поставками электронных компонентов импортного и отечественного производства от производителей и со складов крупных дистрибьюторов Европы, Америки и Азии.

С конца 2013 года компания активно расширяет линейку поставок компонентов по направлению коаксиальный кабель, кварцевые генераторы и конденсаторы (керамические, пленочные, электролитические), за счёт заключения дистрибьюторских договоров

Мы предлагаем:

- Конкурентоспособные цены и скидки постоянным клиентам.
- Специальные условия для постоянных клиентов.
- Подбор аналогов.
- Поставку компонентов в любых объемах, удовлетворяющих вашим потребностям.
- Приемлемые сроки поставки, возможна ускоренная поставка.
- Доставку товара в любую точку России и стран СНГ.
- Комплексную поставку.
- Работу по проектам и поставку образцов.
- Формирование склада под заказчика.
- Сертификаты соответствия на поставляемую продукцию (по желанию клиента).
- Тестирование поставляемой продукции.
- Поставку компонентов, требующих военную и космическую приемку.
- Входной контроль качества.
- Наличие сертификата ISO.

В составе нашей компании организован Конструкторский отдел, призванный помогать разработчикам, и инженерам.

Конструкторский отдел помогает осуществить:

- Регистрацию проекта у производителя компонентов.
- Техническую поддержку проекта.
- Защиту от снятия компонента с производства.
- Оценку стоимости проекта по компонентам.
- Изготовление тестовой платы монтаж и пусконаладочные работы.



Тел: +7 (812) 336 43 04 (многоканальный)

Email: [org@lifeelectronics.ru](mailto:org@lifeelectronics.ru)