

THIS DRAWING IS UNPUBLISHED. RELEASED FOR PUBLICATION
 © COPYRIGHT - By - ALL RIGHTS RESERVED.

LOC	DIST	REVISIONS					
		P	LTR	DESCRIPTION	DATE	DWN	APVD
—	—		D9	REVISED PER ECO-12-012202	03JUL12	KH	MS

PHYSICAL PROPERTIES:
 HOUSING MATERIAL: PBT
 FLAMMABILITY: UL94V-0
 COLOR: BLACK

TERMINAL:
 TERMINALS: BRASS, TIN PLATED
 SCREWS: 6-32, STEEL, NICKEL PLATED

MECHANICAL:
 PITCH (TERMINAL SPACING): 9.50mm (.374")
 WIRE RANGE: 12-22 AWG
 RECOMMENDED TIGHTENING TORQUE: 12IN-LBS MAX.

ELECTRICAL PROPERTIES:
 MAXIMUM CURRENT: 20A
 OPERATING VOLTAGE: 300V

ENVIRONMENTAL PROPERTIES:
 OPERATING TEMP RANGE: -40°C TO 120°C

- ① SCREWS ON ONE SIDE IN WIRE READY POSITION.
- ② SEE FIGURE.
- ③ WHITE INK STAMP.
- ④ NICKEL PLATED BRASS SCREWS.
- ⑤ PRELIMINARY PART NUMBER.
- ⑥ TE CONNECTIVITY LOGO LOCATED APPROXIMATE AREA SHOWN.

LOC	DIST	DIM B	DIM A	QC TAB .187 45°	QC TAB .187 FLAT	NO OF POSN	PART NUMBER
⑤②		104.7	112.2	—	—	10	4-1546307-7
⑤②		104.7	112.2	—	—	10	4-1546307-6
⑤④		104.7	112.2	—	—	10	4-1546307-5
⑤②①		104.7	112.2	—	—	10	3-1546307-3
		104.7	112.2	—	—	10	1-1546307-0
⑤③②①		95.2	102.7	—	9	9	5-1546307-0
⑤③②①		95.2	102.7	4	9	9	4-1546307-9
③②①		95.2	102.7	4	9	9	4-1546307-8
		95.2	102.7	—	—	9	1546307-9
		85.7	93.2	—	—	8	1546307-8
		76.2	83.7	—	—	7	1546307-7
⑤④		66.7	74.2	—	—	6	4-1546307-4
		66.7	74.2	—	—	6	1546307-6
⑤②		57.2	64.7	—	—	5	4-1546307-3
⑤②		57.2	64.7	—	—	5	4-1546307-2
⑤②		57.2	64.7	—	—	5	4-1546307-1
⑤②		57.2	64.7	—	—	5	4-1546307-0
⑤④		57.2	64.7	—	—	5	3-1546307-9
		57.2	64.7	—	—	5	1546307-5
⑤②①		47.7	55.2	—	—	4	3-1546307-2
		47.7	55.2	—	—	4	1546307-4
⑤②		38.2	45.7	—	—	3	3-1546307-8
⑤②		38.2	45.7	—	—	3	3-1546307-7
⑤②		38.2	45.7	—	—	3	3-1546307-6
⑤②		38.2	45.7	—	—	3	3-1546307-5
⑤④		38.2	45.7	—	—	3	3-1546307-4
		38.2	45.7	—	—	3	1546307-3
		28.7	36.2	—	—	2	1546307-2

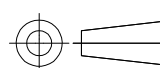
THIS DRAWING IS A CONTROLLED DOCUMENT.		DWN S SCHLEGEL 20AUG2002						
DIMENSIONS: mm		CHK C RICHARD 8/20/02				NAME 9.50MM (.374) DBL ROW BARRIER STRIP W/ WASHER		
TOLERANCES UNLESS OTHERWISE SPECIFIED:		APVD C RICHARD 8/20/02				PRODUCT SPEC —		
		APPLICATION SPEC —		SIZE A3	CAGE CODE 00779	DRAWING NO C-1546307	RESTRICTED TO —	
MATERIAL —		FINISH —		WEIGHT —		SCALE 1:1		
CUSTOMER DRAWING				SHEET 1 OF 3		REV D9		

THIS DRAWING IS UNPUBLISHED. RELEASED FOR PUBLICATION
 © COPYRIGHT - By - ALL RIGHTS RESERVED.

LOC	DIST	REVISIONS					
		P	LTR	DESCRIPTION	DATE	DWN	APVD
-	-	-	-	SEE SHEET 1	-	-	-



3-1546307-1



3-1546307-5



3-1546307-2

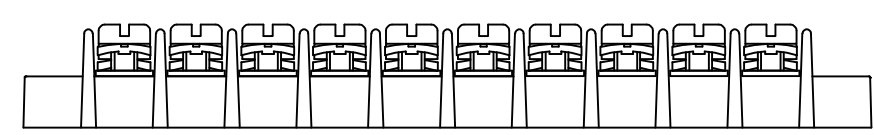
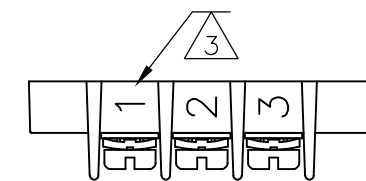
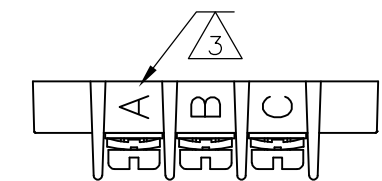

3-1546307-3



3-1546307-7



3-1546307-8

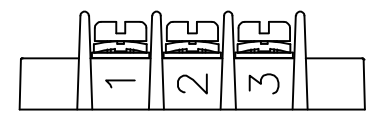

3-1546307-6

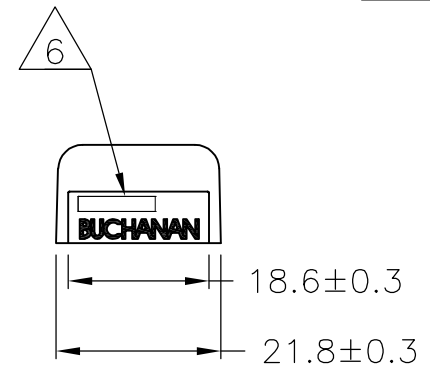
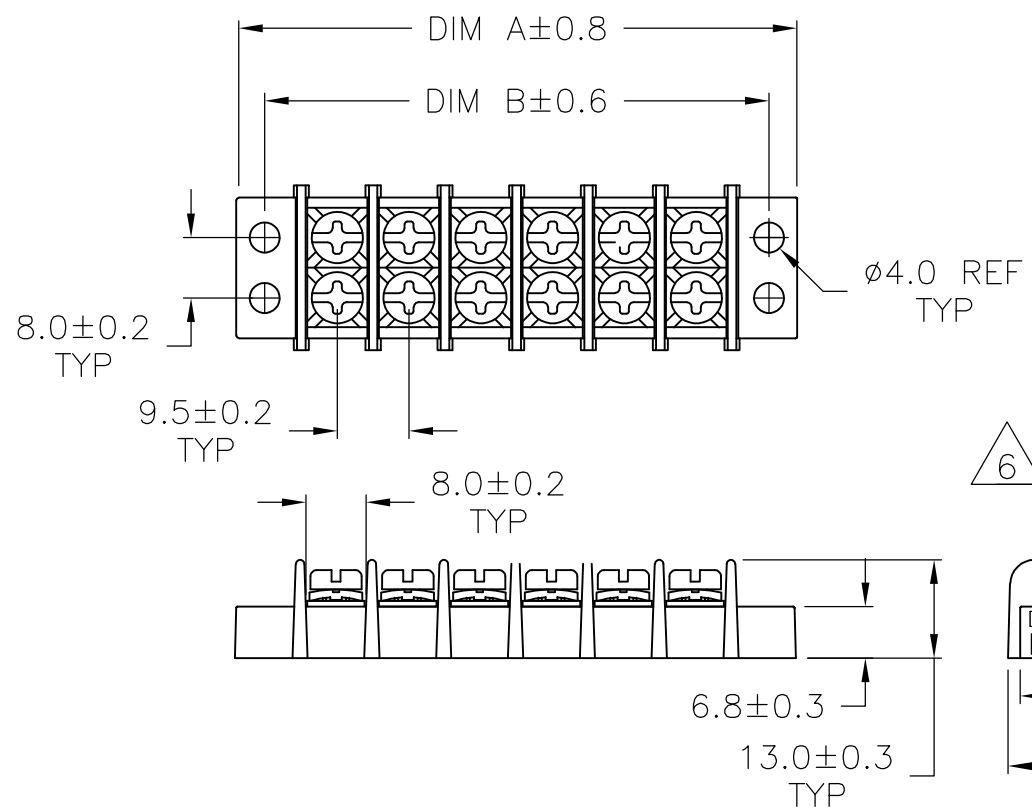

294.7	302.2	-	-	30	3-1546307-0
285.2	292.7	-	-	29	2-1546307-9
275.7	283.2	-	-	28	2-1546307-8
266.2	273.7	-	-	27	2-1546307-7
256.7	264.2	-	-	26	2-1546307-6
247.2	254.7	-	-	25	2-1546307-5
237.7	245.2	-	-	24	2-1546307-4
228.2	235.7	-	-	23	2-1546307-3
218.7	226.2	-	-	22	2-1546307-2
209.2	216.7	-	-	21	2-1546307-1
199.7	207.2	-	-	20	3-1546307-1
199.7	207.2	-	-	20	2-1546307-0
190.2	197.7	-	-	19	1-1546307-9
180.7	188.2	-	-	18	1-1546307-8
171.2	178.7	-	-	17	1-1546307-7
161.7	169.2	-	-	16	1-1546307-6
152.2	159.7	-	-	15	1-1546307-5
142.7	150.2	-	-	14	1-1546307-4
133.2	140.7	-	-	13	1-1546307-3
123.7	131.2	-	-	12	1-1546307-2
114.2	121.7	-	-	11	1-1546307-1
DIM B	DIM A	QC TAB .187 45° (2)	QC TAB .187 FLAT (1)	NO OF POSN	PART NUMBER

THIS DRAWING IS A CONTROLLED DOCUMENT.		DWN S SCHLEGEL 20AUG2002	TE Connectivity		
DIMENSIONS: mm		CHK C RICHARD 8/20/02			
TOLERANCES UNLESS OTHERWISE SPECIFIED:		APVD C RICHARD 8/20/02	PRODUCT SPEC		
0 PLC ± - 1 PLC ± 0.3 2 PLC ± 0.25 3 PLC ± - 4 PLC ± - ANGLES ± 2°		APPLICATION SPEC		RESTRICTED TO	
MATERIAL		WEIGHT -	SIZE A3	CAGE CODE 00779	DRAWING NO C-1546307
		CUSTOMER DRAWING		SCALE 1:1	SHEET 2 OF 3
				REV D9	

THIS DRAWING IS UNPUBLISHED.

RELEASED FOR PUBLICATION

ALL RIGHTS RESERVED.

© COPYRIGHT - By -

LOC - -

DIST - -

P - -

LTR - -

REVISIONS

DESCRIPTION	DATE	DWN	APVD
SEE SHEET 1	-	-	-

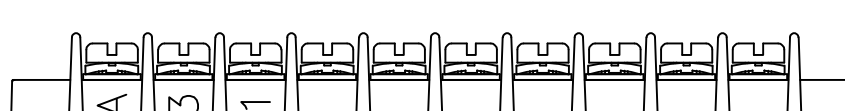
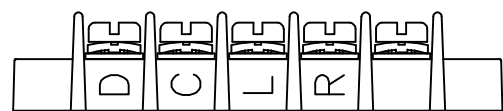
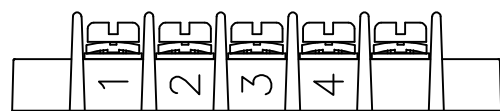
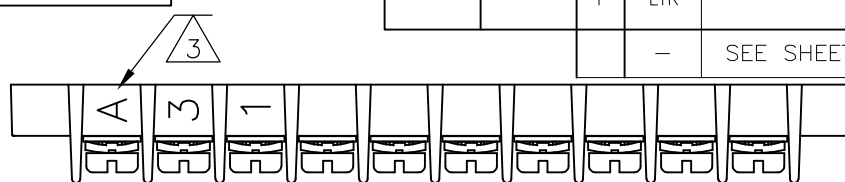
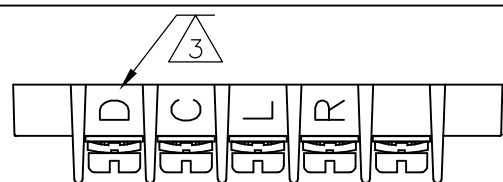
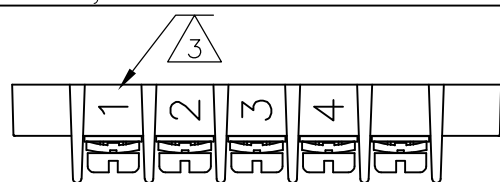

4-1546307-2

4-1546307-3

4-1546307-7

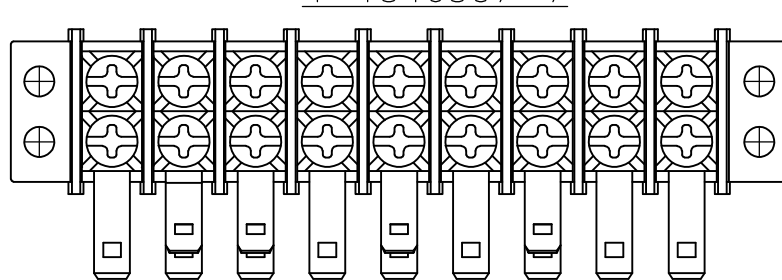
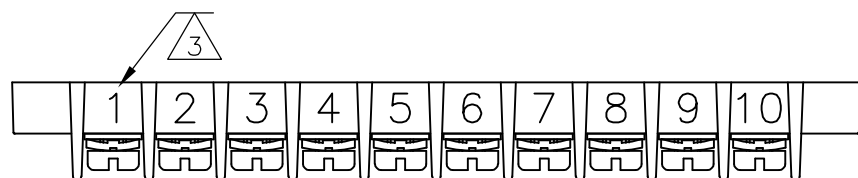

4-1546307-6

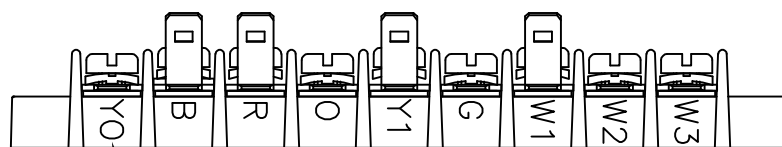
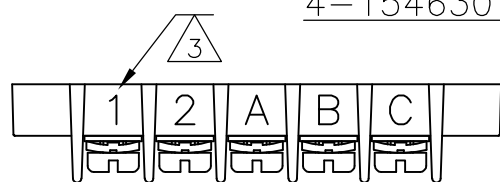

4-1546307-0

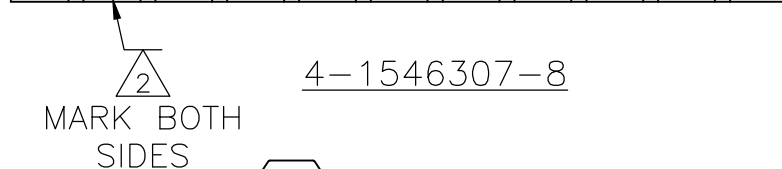
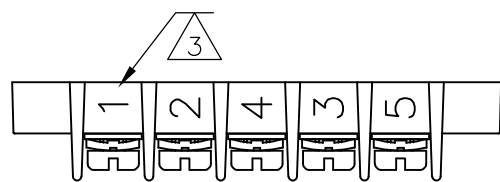

4-1546307-8

4-1546307-1

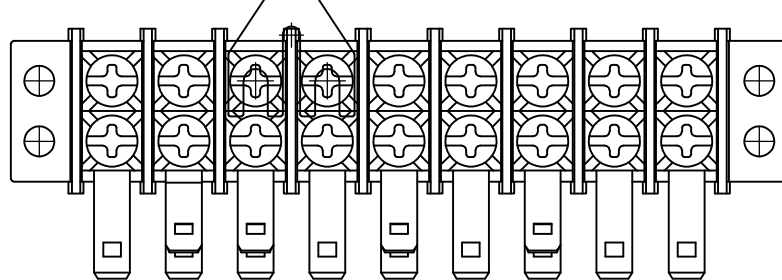
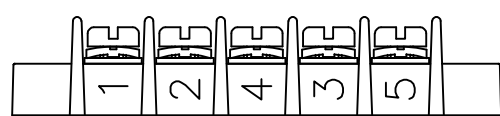

4-1546307-9

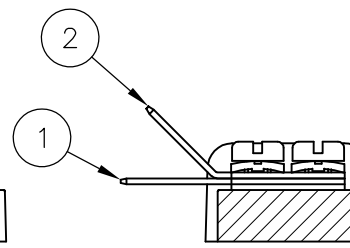
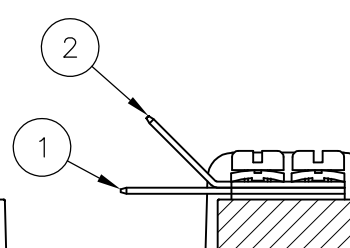

MARK BOTH SIDES

MARK BOTH SIDES

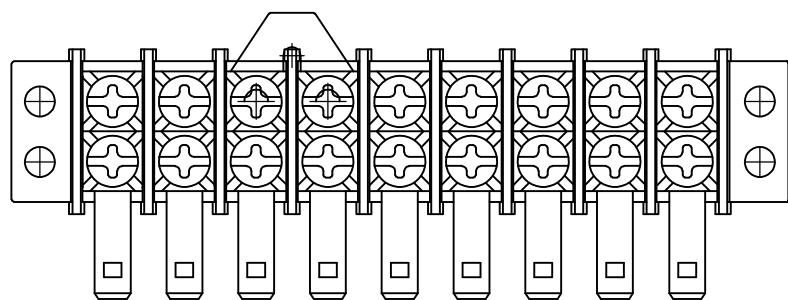

5-1546307-0

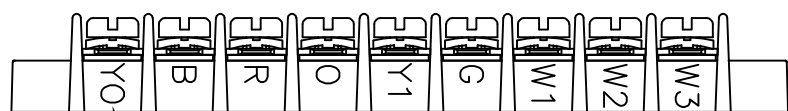

MARK BOTH SIDES

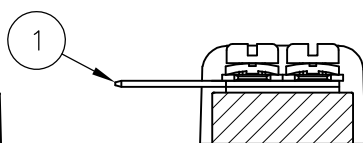

THIS DRAWING IS A CONTROLLED DOCUMENT.

DIMENSIONS:

mm

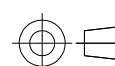

TOLERANCES UNLESS OTHERWISE SPECIFIED:

0 PLC	± -
1 PLC	± 0.3
2 PLC	± 0.25
3 PLC	± -
4 PLC	± -
ANGLES	± 2'
FINISH	-

MATERIAL

-

DWN 20AUG2002

S SCHLEGEL

CHK 8/20/02

C RICHARD

APVD 8/20/02

C RICHARD

PRODUCT SPEC

APPLICATION SPEC

WEIGHT

-

STE TE Connectivity

NAME
9.50MM (.374) DBL ROW BARRIER STRIP
W/ WASHER

SIZE	CAGE CODE	DRAWING NO	RESTRICTED TO
A3	00779	C-1546307	-

CUSTOMER DRAWING

SCALE 1:1

SHEET 3 OF 3

REV D9

Компания «Life Electronics» занимается поставками электронных компонентов импортного и отечественного производства от производителей и со складов крупных дистрибьюторов Европы, Америки и Азии.

С конца 2013 года компания активно расширяет линейку поставок компонентов по направлению коаксиальный кабель, кварцевые генераторы и конденсаторы (керамические, пленочные, электролитические), за счёт заключения дистрибьюторских договоров

Мы предлагаем:

- Конкурентоспособные цены и скидки постоянным клиентам.
- Специальные условия для постоянных клиентов.
- Подбор аналогов.
- Поставку компонентов в любых объемах, удовлетворяющих вашим потребностям.
- Приемлемые сроки поставки, возможна ускоренная поставка.
- Доставку товара в любую точку России и стран СНГ.
- Комплексную поставку.
- Работу по проектам и поставку образцов.
- Формирование склада под заказчика.
- Сертификаты соответствия на поставляемую продукцию (по желанию клиента).
- Тестирование поставляемой продукции.
- Поставку компонентов, требующих военную и космическую приемку.
- Входной контроль качества.
- Наличие сертификата ISO.

В составе нашей компании организован Конструкторский отдел, призванный помогать разработчикам, и инженерам.

Конструкторский отдел помогает осуществить:

- Регистрацию проекта у производителя компонентов.
- Техническую поддержку проекта.
- Защиту от снятия компонента с производства.
- Оценку стоимости проекта по компонентам.
- Изготовление тестовой платы монтаж и пусконаладочные работы.



Тел: +7 (812) 336 43 04 (многоканальный)
Email: org@lifeelectronics.ru