

High Performance RFI Power Line Filters for Switching Power Supplies

T Series



UL Recognized
CSA Certified
VDE Approved



T Series

- Superior common-mode and premium differential-mode attenuation
- Smaller package sizes than the EP Series
- Size and cost-effective
- ET models can help meet very low leakage current requirements

Ordering Information

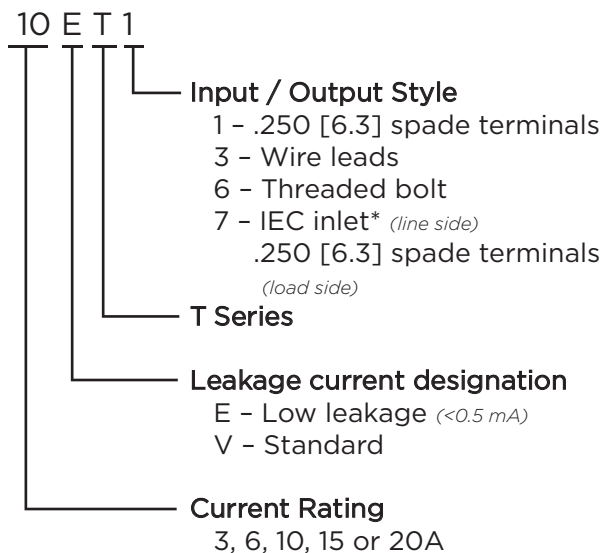

*IEC 60320-1 C14 inlet mates with C13 connector

Specifications

Maximum leakage current each Line to Ground:

| | ET Models | VT Models |
|-----------------------|-----------|-----------|
| 3, 6 & 10A | | |
| @120 VAC 60 Hz: | .30 mA | .75 mA |
| @250 VAC 50 Hz: | .50 mA | 1.2 mA |
| 15 & 20A | | |
| @120 VAC 60 Hz: | .30 mA | 1.2 mA |
| @250 VAC 50 Hz: | .50 mA | 2.0 mA |

Hipot rating (one minute):

| | |
|-----------------|----------|
| Line to Ground: | 2250 VDC |
| Line to Line: | 1450 VDC |

Rated Voltage (max): 250 VAC

Operating Frequency: 50/60 Hz

Rated Current: 3 to 20A

Operating Ambient Temperature Range

(at rated current I_r): -10°C to +40°C
In an ambient temperature (T_a) higher than +40°C the maximum operating current (I_o) is calculated as follows: $I_o = I_r \sqrt{(85-T_a)/45}$

Available Part Numbers

| | | |
|------|-------|-------|
| 3ET1 | 10ET1 | 10VT1 |
| 3ET3 | 10ET3 | 10VT3 |
| 3ET7 | 15ET1 | 15VT1 |
| 6ET1 | 15ET6 | 15VT6 |
| 6ET3 | 20ET1 | 20VT1 |
| 6ET7 | 20ET6 | 20VT6 |

High Performance RFI Filters for Switching Power Supplies *(continued)*

T Series

Electrical Schematics

3 & 6A



10A

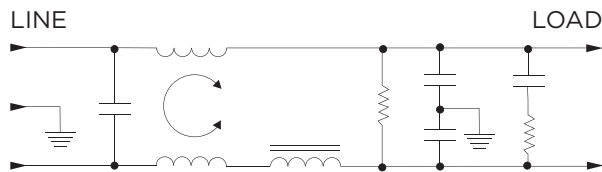

15 & 20A

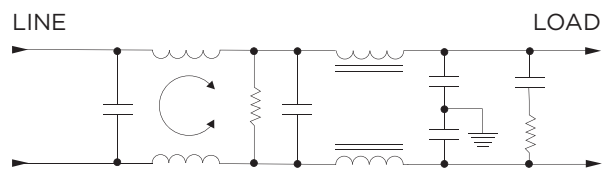

Accessories

GA400: NEMA 5-15P to IEC 60320-1 C-13 line cord

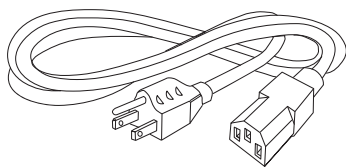

Case Styles

T1 (3, 6, 10A)

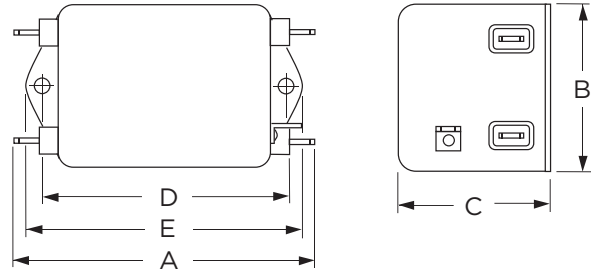

Typical Dimensions:

- Line/Load Terminals (4): .250 [6.3] with .07 [1.8] Dia. hole
- Ground Terminal (1): .250 [6.3] with .07 x .16 [1.8 x 3.8] slot
- Mounting Holes (2): .188 [4.78] Dia.

T1 (15 & 20A)

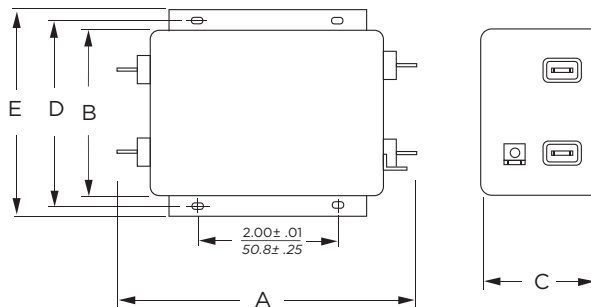

Typical Dimensions:

- Line/Load Terminals (4): .250 [6.3] with .07 [1.8] Dia. hole
- Ground Terminal (1): .250 [6.3] with .07 x .16 [1.8 x 3.8] slot
- Mounting Slots (4): .250 x .156 [6.35 x 3.96] Dia.

T3



Typical Dimensions:

- Wire Leads (5): 4.0 [101.6] Min., AWG18
- Mounting Holes (2): .188 [4.78] Dia.

High Performance RFI Filters for Switching Power Supplies *(continued)*

T Series

Case Styles *(continued)*

T6



Typical Dimensions:
 Terminals (5): 8-32, Torque 18 lbf-in. [2.03 N-m] max. ± 2 [.22]
 Mounting Slots (4): .250 x .156 [6.35 x 3.96] Dia.

T7



Typical Dimensions:
 Load Terminals (2): .250 [6.3] with .07 [1.8] Dia. hole
 Ground Terminal (1): .250 [6.3] with .07 x .16 [1.8 x 3.8] slot
 Line Inlet (1): IEC 60320-1 C14
 Tapped Inserts (2): 6-32 x 1/4

Case Dimensions

| Part No. | A (max) | B (max) | C (max) | D $\pm .015$ $\pm .38$ | E (max) |
|-------------------------------|----------------------|---------------------|---------------------|------------------------------|-----------------------|
| 3ET1, 6ET1 | 3.56 90.4 | 2.15 54.6 | 1.81 46.0 | 2.938 74.63 | 3.38 85.9 |
| 3ET3, 6ET3 | 2.55 64.8 | 2.15 54.6 | 1.81 46.0 | 2.938 74.63 | 3.38 85.9 |
| 3ET7, 6ET7 | 3.52 89.4 | 2.25 57.2 | 1.78 45.2 | 1.575 40.01 | 0.63* 16.0* |
| 10ET1, 10VT1 | 4.69 119.1 | 2.27 57.7 | 1.80 45.7 | 4.063 103.2 | 4.47 113.5 |
| 10ET3, 10VT3 | 3.69 93.7 | 2.27 57.7 | 1.80 45.7 | 4.063 103.2 | 4.47 113.5 |
| 15ET1, 15VT1, 20ET1, 20VT1 | 5.45 138.4 | 3.12 79.2 | 2.18 55.4 | 3.5 88.9 | 3.96 100.6 |
| 15ET6, 15VT6, 20ET6, 20VT6 | 5.95 151.1 | 3.12 79.2 | 2.18 55.4 | 3.5 88.9 | 3.96 100.6 |

*±0.02 [0.5]

Recommended Panel Cutout

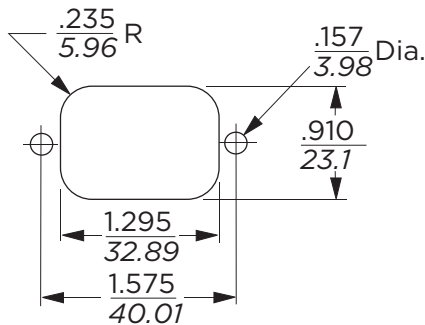

Tolerance ± .005 [0.13]

High Performance RFI Filters for Switching Power Supplies *(continued)*

T Series

Performance Data

Typical Insertion Loss

Measured in closed 50 Ohm system

— Common Mode / Asymmetrical (L-G)
— Differential Mode / Symmetrical (L-L)

3ET

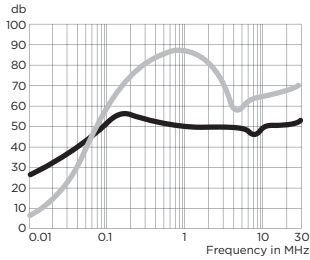

6ET

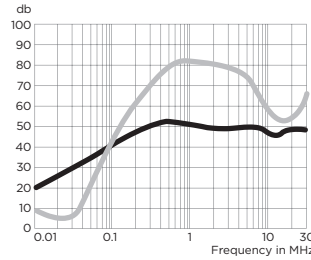

10ET

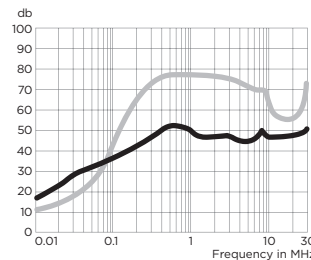

15ET

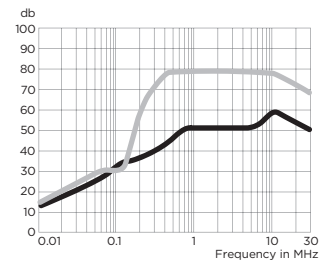

20ET

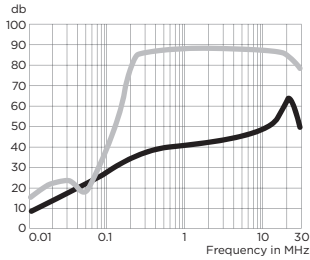

10VT

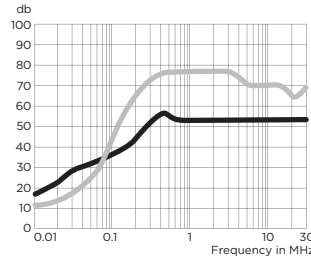

15VT

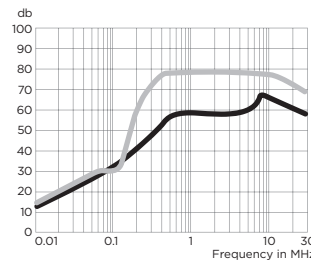

20VT

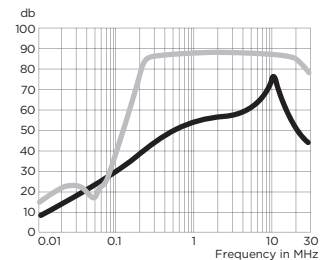

Minimum Insertion Loss

Measured in closed 50 Ohm system

Common Mode / Asymmetrical (Line to Ground)

| Current Rating | Frequency – MHz | | | | | | | | | | |
|------------------|-----------------|-----|-----|-----|----|----|----|----|----|----|----|
| | .01 | .03 | .05 | .15 | .5 | 1 | 2 | 5 | 10 | 20 | 30 |
| ET Models | | | | | | | | | | | |
| 3A | 22 | 32 | 36 | 46 | 47 | 44 | 43 | 40 | 42 | 42 | 42 |
| 6A | 16 | 26 | 30 | 41 | 47 | 44 | 43 | 43 | 40 | 42 | 42 |
| 10A | 12 | 22 | 26 | 36 | 47 | 42 | 42 | 40 | 42 | 42 | 45 |
| 15A | 8 | 17 | 22 | 31 | 43 | 44 | 44 | 42 | 47 | 52 | 43 |
| 20A | 3 | 12 | 17 | 26 | 34 | 36 | 37 | 37 | 42 | 47 | 38 |

Differential Mode / Symmetrical (Line to Line)

| Current Rating | Frequency – MHz | | | | | | | | | | |
|------------------|-----------------|-----|-----|-----|----|----|----|----|----|----|----|
| | .01 | .03 | .05 | .15 | .5 | 1 | 2 | 5 | 10 | 20 | 30 |
| ET Models | | | | | | | | | | | |
| 3A | 3 | 1 | 30 | 61 | 70 | 70 | 70 | 70 | 50 | 50 | 55 |
| 6A | 4 | 2 | 14 | 51 | 70 | 70 | 70 | 65 | 47 | 50 | 55 |
| 10A | 7 | 12 | 17 | 52 | 70 | 70 | 70 | 65 | 55 | 50 | 60 |
| 15A | 12 | 19 | 15 | 51 | 70 | 70 | 70 | 70 | 70 | 65 | 60 |
| 20A | 10 | 17 | 13 | 51 | 70 | 70 | 70 | 70 | 67 | 65 | 60 |

VT Models

| | | | | | | | | | | | |
|-----|----|----|----|----|----|----|----|----|----|----|----|
| 10A | 12 | 22 | 26 | 38 | 52 | 50 | 50 | 50 | 50 | 50 | 50 |
| 15A | 8 | 17 | 22 | 33 | 52 | 52 | 52 | 52 | 57 | 45 | 35 |
| 20A | 3 | 12 | 17 | 29 | 42 | 47 | 50 | 51 | 55 | 40 | 30 |

VT Models

| | | | | | | | | | | | |
|-----|----|----|----|----|----|----|----|----|----|----|----|
| 10A | 7 | 12 | 17 | 52 | 70 | 70 | 70 | 65 | 65 | 50 | 65 |
| 15A | 12 | 19 | 15 | 51 | 70 | 70 | 70 | 70 | 70 | 65 | 60 |
| 20A | 10 | 17 | 13 | 51 | 70 | 70 | 70 | 70 | 67 | 65 | 60 |

Компания «Life Electronics» занимается поставками электронных компонентов импортного и отечественного производства от производителей и со складов крупных дистрибьюторов Европы, Америки и Азии.

С конца 2013 года компания активно расширяет линейку поставок компонентов по направлению коаксиальный кабель, кварцевые генераторы и конденсаторы (керамические, пленочные, электролитические), за счёт заключения дистрибьюторских договоров

Мы предлагаем:

- Конкуренеспособные цены и скидки постоянным клиентам.
- Специальные условия для постоянных клиентов.
- Подбор аналогов.
- Поставку компонентов в любых объемах, удовлетворяющих вашим потребностям.
- Приемлемые сроки поставки, возможна ускоренная поставка.
- Доставку товара в любую точку России и стран СНГ.
- Комплексную поставку.
- Работу по проектам и поставку образцов.
- Формирование склада под заказчика.
- Сертификаты соответствия на поставляемую продукцию (по желанию клиента).
- Тестирование поставляемой продукции.
- Поставку компонентов, требующих военную и космическую приемку.
- Входной контроль качества.
- Наличие сертификата ISO.

В составе нашей компании организован Конструкторский отдел, призванный помогать разработчикам, и инженерам.

Конструкторский отдел помогает осуществить:

- Регистрацию проекта у производителя компонентов.
- Техническую поддержку проекта.
- Защиту от снятия компонента с производства.
- Оценку стоимости проекта по компонентам.
- Изготовление тестовой платы монтаж и пусконаладочные работы.



Тел: +7 (812) 336 43 04 (многоканальный)

Email: org@lifeelectronics.ru