

IR Receiver Modules for Remote Control Systems



22531-1



FEATURES

- Very low supply current
- Photo detectors and preamplifier in one package
- Internal filter for PCM frequency
- Supply voltage: 2.5 V to 5.5 V
- Improved immunity against ambient light
- Insensitive to supply voltage ripple and noise
- Material categorization:

For definitions of compliance please see www.vishay.com/doc?99912



RoHS
COMPLIANT
HALOGEN
FREE
GREEN
(5-2008)

ORDERING CODE

Taping:

TSOP37...TT - top view taped

TSOP37...TR - side view taped

DESCRIPTION

The TSOP373.., TSOP375.. series are miniaturized receiver modules for infrared remote control systems. A PIN diode and a preamplifier are assembled on a PCB, the epoxy lens cap is designed as an IR filter.

The demodulated output signal can be directly connected to a microprocessor for decoding. The TSOP373.. is optimized to better suppress spurious pulses from energy saving lamps. The TSOP375.. has an excellent noise suppression. It is immune to dimmed LCD backlighting and any fluorescent lamps. AGC3 and AGC5 may also suppress some data signals in case of continuous transmission.

This component has not been qualified according to automotive specifications.

PARTS TABLE			
AGC	NOISY ENVIRONMENTS AND SHORT BURSTS (AGC3)	VERY NOISY ENVIRONMENTS AND SHORT BURSTS (AGC5)	
Carrier frequency	36 kHz	TSOP37336 (1)(2)	TSOP37536 (1)(2)
	38 kHz	TSOP37338 (3)(4)(5)(6)	TSOP37538 (3)(4)(5)
	40 kHz	TSOP37340	TSOP37540
	56 kHz	TSOP37356	TSOP37556
Package	Belobog		
Pinning	1 = OUT, 2, 3, 6, 7, 8 = GND, 4, 5 = V _S		
Dimensions (mm)	3.95 W x 3.95 H x 0.8 D		
Mounting	SMD		
Application	Remote control		
Best remote control code	(1) MCIR (2) RCMM (3) Mitsubishi (4) RECS-80 Code (5) r-map (6) XMP-1, XMP-2		

BLOCK DIAGRAM

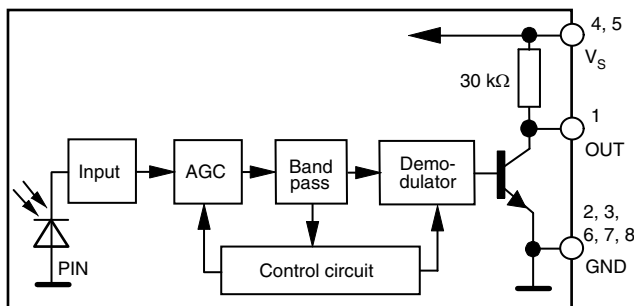

20445-5

APPLICATION CIRCUIT

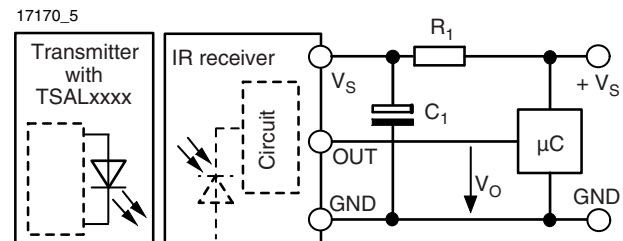

R_1 and C_1 are recommended for protection against EOS. Components should be in the range of $33 \Omega < R_1 < 1 \text{ k}\Omega$, $C_1 > 0.1 \mu\text{F}$.



ABSOLUTE MAXIMUM RATINGS				
PARAMETER	TEST CONDITION	SYMBOL	VALUE	UNIT
Supply voltage		V_S	-0.3 to +6	V
Supply current		I_S	3	mA
Output voltage		V_O	-0.3 to ($V_S + 0.3$)	V
Output current		I_O	5	mA
Junction temperature		T_j	100	°C
Storage temperature range		T_{stg}	-25 to +85	°C
Operating temperature range		T_{amb}	-25 to +85	°C
Power consumption	$T_{amb} \leq 85 \text{ °C}$	P_{tot}	10	mW

Note

- Stresses beyond those listed under “Absolute Maximum Ratings” may cause permanent damage to the device. This is a stress rating only and functional operation of the device at these or any other conditions beyond those indicated in the operational sections of this specification is not implied. Exposure to absolute maximum rating conditions for extended periods may affect the device reliability.

ELECTRICAL AND OPTICAL CHARACTERISTICS ($T_{amb} = 25 \text{ °C}$, unless otherwise specified)						
PARAMETER	TEST CONDITION	SYMBOL	MIN.	TYP.	MAX.	UNIT
Supply voltage		V_S	2.5		5.5	V
Supply current	$V_S = 3.3 \text{ V}, E_v = 0$	I_{SD}	0.27	0.35	0.45	mA
	$E_v = 40 \text{ klx}$, sunlight	I_{SH}		0.45		mA
Transmission distance	$E_v = 0$, IR diode TSAL6200, $I_F = 200 \text{ mA}$, test signal see fig. 1	d		45		m
Output voltage low	$I_{OSL} = 0.5 \text{ mA}$, $E_e = 0.7 \text{ mW/m}^2$, test signal see fig. 1	V_{OSL}			100	mV
Minimum irradiance	Pulse width tolerance: $t_{pi} - 5/f_0 < t_{po} < t_{pi} + 6/f_0$, test signal see fig. 1	$E_e \text{ min.}$		0.12	0.25	mW/m^2
Maximum irradiance	$t_{pi} - 5/f_0 < t_{po} < t_{pi} + 6/f_0$, test signal see fig. 1	$E_e \text{ max.}$	30			W/m^2
Directivity	Angle of half transmission distance	$\Phi_{1/2}$		± 75		deg

TYPICAL CHARACTERISTICS ($T_{amb} = 25 \text{ °C}$, unless otherwise specified)

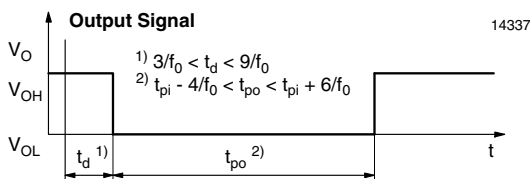
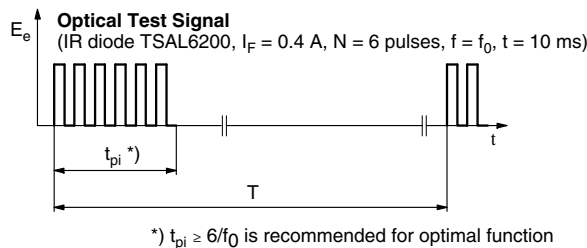

Fig. 1 - Output Function

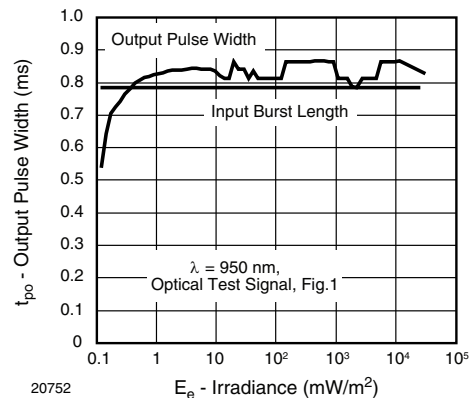

Fig. 2 - Output Pulse Width vs. Irradiance

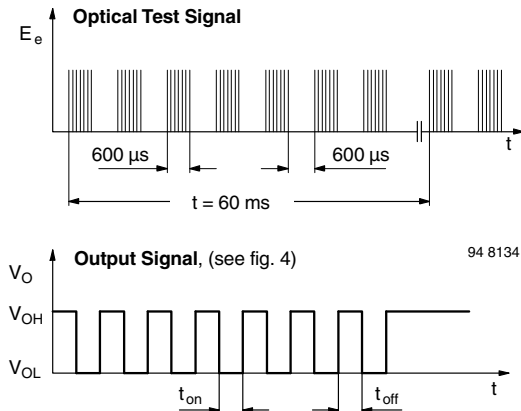

Fig. 3 - Output Function

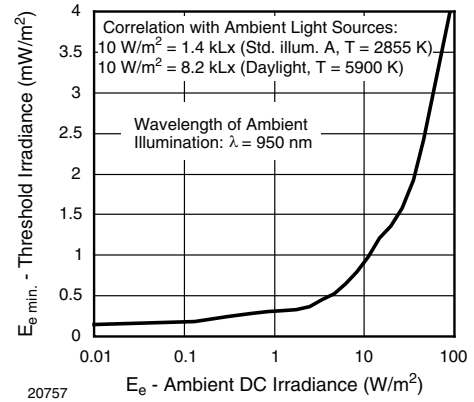

Fig. 6 - Sensitivity in Bright Ambient

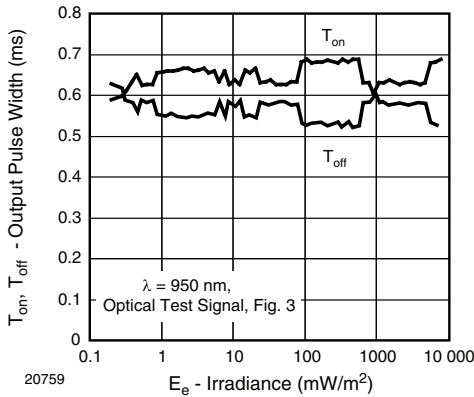

Fig. 4 - Output Pulse Diagram

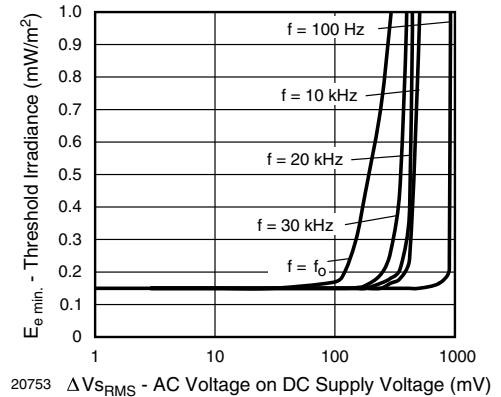

Fig. 7 - Sensitivity vs. Supply Voltage Disturbances



Fig. 5 - Frequency Dependence of Responsivity

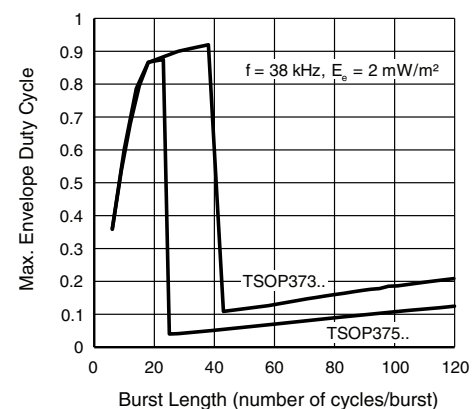

Fig. 8 - Max. Envelope Duty Cycle vs. Burst Length

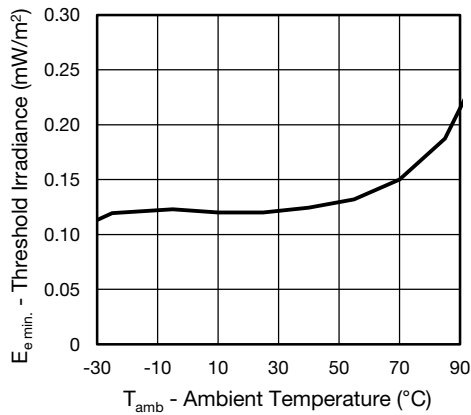

Fig. 9 - Sensitivity vs. Ambient Temperature



Fig. 11 - Directivity

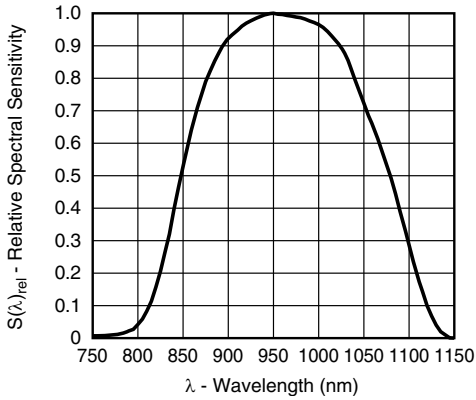

Fig. 10 - Relative Spectral Sensitivity vs. Wavelength

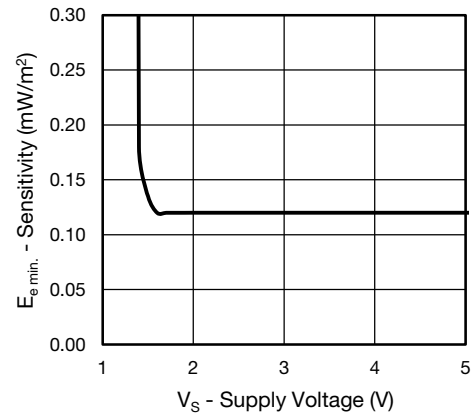

Fig. 12 - Sensitivity vs. Supply Voltage

SUITABLE DATA FORMAT

The TSOP373.., TSOP375.. series is designed to suppress spurious output pulses due to noise or disturbance signals. The devices can distinguish data signals from noise due to differences in frequency, burst length, and envelope duty cycle. The data signal should be close to the device's band-pass center frequency (e.g. 38 kHz) and fulfill the conditions in the table below.

When a data signal is applied to the TSOP373.., TSOP375.. in the presence of a disturbance, the sensitivity of the receiver is automatically reduced by the AGC to insure that no spurious pulses are present at the receiver's output. Some examples which are suppressed are:

- DC light (e.g. from tungsten bulbs sunlight)
- Continuous signals at any frequency
- Strongly or weakly modulated patterns from fluorescent lamps with electronic ballasts (see figure 12 or figure 13)



Fig. 13 - IR Signal from Fluorescent Lamp with Low Modulation

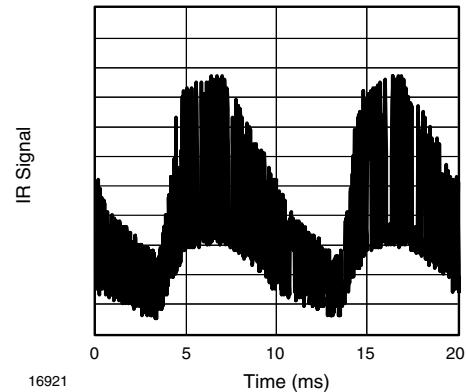

Fig. 14 - IR Signal from Fluorescent Lamp with High Modulation

	TSOP373..	TSOP375..
Minimum burst length	6 cycles/burst	6 cycles/burst
After each burst of length a minimum gap time is required of	6 to 35 cycles ≥ 10 cycles	6 to 24 cycles ≥ 10 cycles
For bursts greater than a minimum gap time in the data stream is needed of	35 cycles > 6 x burst length	24 cycles > 25 ms
Maximum number of continuous short bursts/second	2000	2000
MCIR code	preferred	yes
RCMM code	preferred	yes
XMP-1, XMP-2 code	preferred	yes
Suppression of interference from fluorescent lamps	Even critical disturbance patterns are suppressed (example: signal pattern of fig. 12 and fig. 13)	Even critical disturbance patterns are suppressed (example: signal pattern of fig. 12 and fig. 13)

Notes

- For data formats with long bursts (more than 10 carrier cycles) please see the datasheet for TSOP372.., TSOP374..
- Best choice of AGC for some popular IR-codes:
 - TSOP37336: MCIR, RCMM
 - TSOP37538: Mitsubishi, RECS-80 Code
 - TSOP37338: XMP-1, XMP-2, r-map

PACKAGE DIMENSIONS in millimeters



All dimensions in mm
Not indicated tolerances ± 0.1

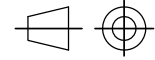

technical drawings according to DIN specifications

(2) Pins connected internally. It is not necessary to connect externally.

Pinning from Topview

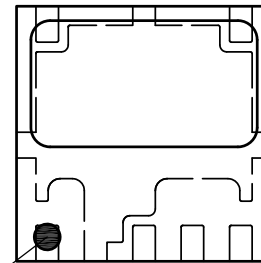

Pin 1 Identification

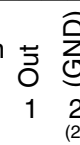

(1) optically effective area

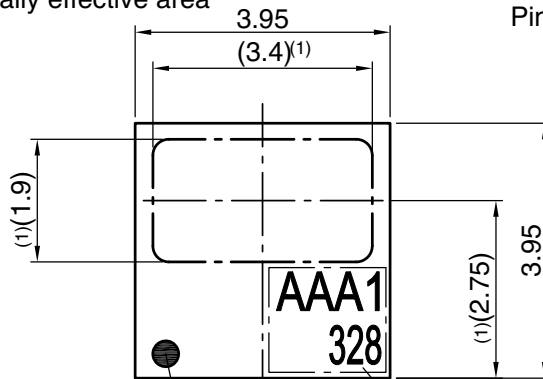

Pin 1 Identification

marking area

Drawing refers to following types: TSOP37... / TSOP57...

Drawing-No.: 6.550-5315.01-4

Issue: 2; 12.02.14

Proposed pad layout from component side
(dim. for reference only)

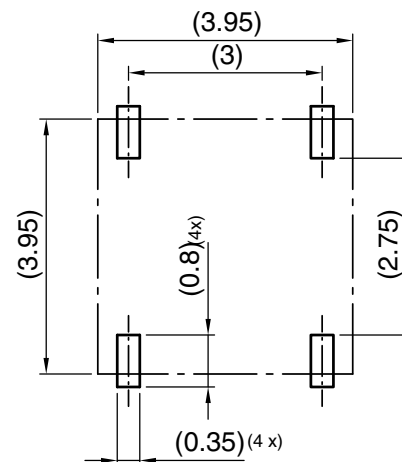



ASSEMBLY INSTRUCTIONS

Reflow Soldering

- Reflow soldering must be done within 168 h while stored under a max. temperature of 30 °C, 60 % RH after opening the dry pack envelope
- Set the furnace temperatures for pre-heating and heating in accordance with the reflow temperature profile as shown in the diagram. Exercise extreme care to keep the maximum temperature below 260 °C. The temperature shown in the profile means the temperature at the device surface. Since there is a temperature difference between the component and the circuit board, it should be verified that the temperature of the device is accurately being measured
- Handling after reflow should be done only after the work surface has been cooled off

Manual Soldering

- Use a soldering iron of 25 W or less. Adjust the temperature of the soldering iron below 300 °C
- Finish soldering within 3 s
- Handle products only after the temperature has cooled off

VISHAY LEAD (Pb)-FREE REFLOW SOLDER PROFILE



ORDERING INFORMATION			
ORDERING CODE	PACKAGING	VOLUME ⁽¹⁾	REMARKS
TSOP37..TT1	Tape and reel	MOQ: 1800 pcs	3.95 mm x 3.95 mm x 0.75 mm
TSOP37..TT2		MOQ: 7000 pcs	

Note

⁽¹⁾ MOQ: minimum order quantity



TAPING VERSION TSOP37... DIMENSIONS in millimeters



Drawing-No.: 9.700-5347.01-4
Issue: 1; 14.11.11

Not indicated tolerances ± 0.1

LABEL
Standard bar code labels for finished goods

The standard bar code labels are product labels and used for identification of goods. The finished goods are packed in final packing area. The standard packing units are labeled

with standard bar code labels before transported as finished goods to warehouses. The labels are on each packing unit and contain Vishay Semiconductor GmbH specific data.

VISHAY SEMICONDUCTOR GmbH STANDARD BAR CODE PRODUCT LABEL (Finished goods)		
PLAIN WRITING	ABBREVIATION	LENGTH
Item-description	-	18
Item-number	INO	8
Selection-code	SEL	3
LOT-/serial-number	BATCH	10
Data-code	COD	3 (YWW)
Plant-code	PTC	2
Quantity	QTY	8
Accepted by	ACC	-
Packed by	PCK	-
Mixed code indicator	MIXED CODE	-
Origin	xxxxxxx+	Company logo
Long bar code top	Type	Length
Item-number	N	8
Plant-code	N	2
Sequence-number	X	3
Quantity	N	8
Total length	-	21
Short bar code bottom	Type	Length
Selection-code	X	3
Data-code	N	3
Batch-number	X	10
Filter	-	1
Total length	-	17

DRY PACKING

The reel is packed in an anti-humidity bag to protect the devices from absorbing moisture during transportation and storage.

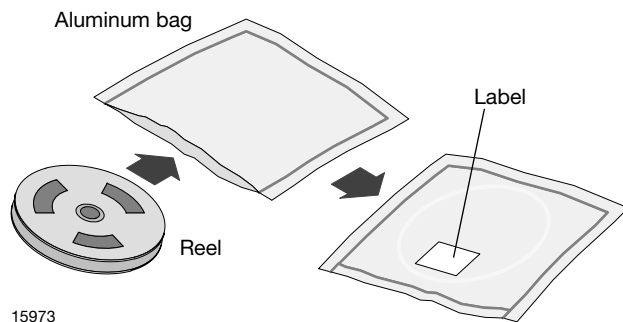
FINAL PACKING

The sealed reel is packed into a cardboard box. A secondary cardboard box is used for shipping purposes.

RECOMMENDED METHOD OF STORAGE

Dry box storage is recommended as soon as the aluminum bag has been opened to prevent moisture absorption. The following conditions should be observed, if dry boxes are not available:

- Storage temperature 10 °C to 30 °C
- Storage humidity ≤ 60 % RH max.

After more than 168 h under these conditions moisture content will be too high for reflow soldering.

In case of moisture absorption, the devices will recover to the former condition by drying under the following condition: 192 h at 40 °C + 5 °C / - 0 °C and < 5 % RH (dry air/nitrogen) or

96 h at 60 °C + 5 °C and < 5 % RH for all device containers or

24 h at 125 °C + 5 °C not suitable for reel or tubes.

An EIA JEDEC® standard J-STD-020 level 3 label is included on all dry bags.



VISHAY SEMICONDUCTORS STANDARD BAR CODE LABELS

The Vishay Semiconductors standard bar code labels are printed at final packing areas. The labels are on each packing unit and contain Vishay Semiconductors specific data.

BAR CODE PRODUCT LABEL (Example)

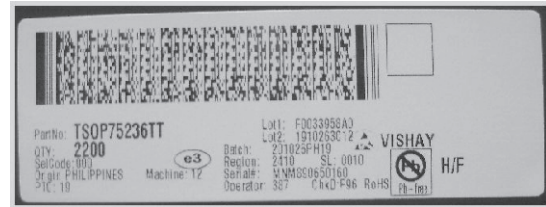

22178



Caution
This bag contains
MOISTURE-SENSITIVE DEVICES

LEVEL
3

If blank, see adjacent bar code label

1. Calculated shelf life in sealed bag: 12 months at -40°C and <math><90\%</math> relative humidity (RH)
2. Peak package body temperature: 260 $^{\circ}\text{C}$
If blank, see adjacent bar code label
3. After bag is opened, devices that will be subjected to reflow solder or other high temperature process must be
 - a) Mounted within: 168 hours of factory conditions
If blank, see adjacent bar code label
$\leq 30^{\circ}\text{C}/60\% \text{ RH}$, or
 - b) Stored per J-STD-033
4. Devices require bake, before mounting, if:
 - a) Humidity Indicator Card reads > 10% for level 2a - 5a devices or >60% for level 2 devices when read at $23\pm 5^{\circ}\text{C}$
 - b) 3a or 3b are not met
5. If baking is required, refer to IPC/JEDEC J-STD-033 for bake procedure

Bag Seal Date: _____
If blank, see adjacent bar code label

Note: Level and body temperature defined by IPC/JEDEC J-STD-020

22650

EIA JEDC standard J-STD-020 level 3 label is included on all dry bags

ESD PRECAUTION

Proper storage and handling procedures should be followed to prevent ESD damage to the devices especially when they are removed from the antistatic shielding bag. Electrostatic sensitive devices warning labels are on the packaging.



Disclaimer

ALL PRODUCT, PRODUCT SPECIFICATIONS AND DATA ARE SUBJECT TO CHANGE WITHOUT NOTICE TO IMPROVE RELIABILITY, FUNCTION OR DESIGN OR OTHERWISE.

Vishay Intertechnology, Inc., its affiliates, agents, and employees, and all persons acting on its or their behalf (collectively, "Vishay"), disclaim any and all liability for any errors, inaccuracies or incompleteness contained in any datasheet or in any other disclosure relating to any product.

Vishay makes no warranty, representation or guarantee regarding the suitability of the products for any particular purpose or the continuing production of any product. To the maximum extent permitted by applicable law, Vishay disclaims (i) any and all liability arising out of the application or use of any product, (ii) any and all liability, including without limitation special, consequential or incidental damages, and (iii) any and all implied warranties, including warranties of fitness for particular purpose, non-infringement and merchantability.

Statements regarding the suitability of products for certain types of applications are based on Vishay's knowledge of typical requirements that are often placed on Vishay products in generic applications. Such statements are not binding statements about the suitability of products for a particular application. It is the customer's responsibility to validate that a particular product with the properties described in the product specification is suitable for use in a particular application. Parameters provided in datasheets and/or specifications may vary in different applications and performance may vary over time. All operating parameters, including typical parameters, must be validated for each customer application by the customer's technical experts. Product specifications do not expand or otherwise modify Vishay's terms and conditions of purchase, including but not limited to the warranty expressed therein.

Except as expressly indicated in writing, Vishay products are not designed for use in medical, life-saving, or life-sustaining applications or for any other application in which the failure of the Vishay product could result in personal injury or death. Customers using or selling Vishay products not expressly indicated for use in such applications do so at their own risk. Please contact authorized Vishay personnel to obtain written terms and conditions regarding products designed for such applications.

No license, express or implied, by estoppel or otherwise, to any intellectual property rights is granted by this document or by any conduct of Vishay. Product names and markings noted herein may be trademarks of their respective owners.

Material Category Policy

Vishay Intertechnology, Inc. hereby certifies that all its products that are identified as RoHS-Compliant fulfill the definitions and restrictions defined under Directive 2011/65/EU of The European Parliament and of the Council of June 8, 2011 on the restriction of the use of certain hazardous substances in electrical and electronic equipment (EEE) - recast, unless otherwise specified as non-compliant.

Please note that some Vishay documentation may still make reference to RoHS Directive 2002/95/EC. We confirm that all the products identified as being compliant to Directive 2002/95/EC conform to Directive 2011/65/EU.

Vishay Intertechnology, Inc. hereby certifies that all its products that are identified as Halogen-Free follow Halogen-Free requirements as per JEDEC JS709A standards. Please note that some Vishay documentation may still make reference to the IEC 61249-2-21 definition. We confirm that all the products identified as being compliant to IEC 61249-2-21 conform to JEDEC JS709A standards.

Компания «Life Electronics» занимается поставками электронных компонентов импортного и отечественного производства от производителей и со складов крупных дистрибьюторов Европы, Америки и Азии.

С конца 2013 года компания активно расширяет линейку поставок компонентов по направлению коаксиальный кабель, кварцевые генераторы и конденсаторы (керамические, пленочные, электролитические), за счёт заключения дистрибьюторских договоров

Мы предлагаем:

- Конкурентоспособные цены и скидки постоянным клиентам.
- Специальные условия для постоянных клиентов.
- Подбор аналогов.
- Поставку компонентов в любых объемах, удовлетворяющих вашим потребностям.
- Приемлемые сроки поставки, возможна ускоренная поставка.
- Доставку товара в любую точку России и стран СНГ.
- Комплексную поставку.
- Работу по проектам и поставку образцов.
- Формирование склада под заказчика.
- Сертификаты соответствия на поставляемую продукцию (по желанию клиента).
- Тестирование поставляемой продукции.
- Поставку компонентов, требующих военную и космическую приемку.
- Входной контроль качества.
- Наличие сертификата ISO.

В составе нашей компании организован Конструкторский отдел, призванный помогать разработчикам, и инженерам.

Конструкторский отдел помогает осуществить:

- Регистрацию проекта у производителя компонентов.
- Техническую поддержку проекта.
- Защиту от снятия компонента с производства.
- Оценку стоимости проекта по компонентам.
- Изготовление тестовой платы монтаж и пусконаладочные работы.



Тел: +7 (812) 336 43 04 (многоканальный)
Email: org@lifeelectronics.ru