

MAX1471 Evaluation Kit

Evaluates: MAX1471

General Description

The MAX1471 evaluation system (EVSYS) is a complete receiver system consisting of a MAX1471 evaluation kit (EVKIT) and a Maxim CMAXQUSB module. Order the complete EVSYS (MAX1471EVSYS) for comprehensive evaluation of the MAX1471, using a personal computer (PC). Order the evaluation kit (MAX1471EVKIT) separately if the CMAXQUSB module has already been purchased with a previous Maxim system or when using a custom microcontroller-based system.

The MAX1471EVKIT provides a proven design to evaluate the MAX1471 ASK/FSK superheterodyne receiver in a TQFN package with an exposed pad. The EVKIT enables testing of the device's RF performance while the EVSYS provides the added benefit of using a tested digital interface and software GUI. The RF input interface includes an SMA connector for convenient connection to test equipment.

The MAX1471EVKIT is available in two versions: 315MHz (MAX1471EVKIT-315) and 433.92MHz (MAX1471EVKIT-433). The passive components are optimized for these two frequencies but can easily be changed to work at RF frequencies from 300MHz to 450MHz.

There are separate data paths in the MAX1471 for ASK and FSK signals. In this EVKIT, both the ASK and FSK data filter bandwidths are set at 5 kHz, which is recommended for receiving a 4.2 kbps Manchester data rate.

For easy implementation into the customer's design, the MAX1471EVKit also features a proven PCB layout, which can be easily duplicated for quicker time-to-market. The EVKIT Gerber files are available for download at www.maximintegrated.com.

Features

- Proven PC Board Layout
- Proven Components Parts List
- Multiple Test Points Provided on Board
- Available in 315MHz or 433.92MHz Optimized Versions
- Adjustable Frequency Range from 300MHz to 450MHz*
- Fully Assembled and Tested
- Windows 98/2000/XP/7 Compatible Software

*Requires component changes.

Ordering Information appears at end of data sheet.

MAX1471 EV Kit Files

FILE	DESCRIPTION
1471EVkit_SW.zip	MAX1471 software package
Install.exe	MAX1471 software installation
MAX1471.exe	MAX1471 Evaluation Kit software executable
MAX1471.ini	Installation configuration
Unist.ini	Un-install configuration
FTD2XX.dll	USB driver (DLL)
FTD2XX.sys	USB driver system file
FTD2XX.inf	USB driver setup information
FTD2XXUN.ini	Driver installation configuration
FTD2XXUN.exe	Driver installation executable

Windows is a registered trademark and registered service mark of Microsoft Corporation.

Windows XP is a registered trademark and registered service mark of Microsoft Corporation.

Quick Start

Required Equipment

- MAX1471EVKIT
- CMAXQUSB Evaluation Board
- USB Cable (enclosed with CMODUSB board)
- RF signal generator capable of delivering from –120dBm to 0dBm of output power at the operating frequency, in addition to AM or pulse modulation and FM modulation capabilities (Agilent E4420B or equivalent)
- Dual-trace Oscilloscope
- Optional: 3.3V, 20mA DC power supply for running the EVKIT separate from the CMAXQUSB board; ammeter for measuring supply current

Procedure

The MAX1471EVK is fully assembled and tested. Follow the steps below to verify board operation. The MAX1471 ASK/FSK receiver gets its setup information through a 3-wire SPI port. The CMAXQUSB control board is recommended for this function (see the [General Description](#) section) and its use will be assumed in the following procedure. The MAX1471EVSYS connects to the USB port of a computer and the MAX1471 evaluation board gets its DC power from the computer through the USB port.

- 1) Connect the MAX1471 Evaluation Board to the CMODUSB Evaluation Board using the 40-pin connectors.
- 2) Set Jumper J1 on the CMAXQUSB board for 3.3V operation (connect pins 2 and 3).
- 3) Short Jumpers J4 and J8 on the MAX1471 board for 3.3V operation.
- 4) Download the MAX1471 EV kit software from Maxim's website by going to the [EV Kit Software](#) page.
- 5) Connect the USB cable to the CMAXQUSB board and the computer. The computer will tell you that there is new hardware. Go through the installation wizard and direct it to the location where you have stored the MAX1471 EVKit software.
- 6) Start the MAX1471 EVKit software. A display showing the contents of the control registers in the MAX1471 will appear. In a few seconds, the heading at the top should change from "disconnected" to "connected", and the display should look like the display shown in [Figure 1](#).
- 7) To achieve fundamental operation of the MAX1471, you only need to load the registers in the first four rows, that is, Power (PWR), Configuration (CONF), Control (CTRL), and Oscillator (OSC). You can load them either by setting each individual bit or by entering the Hexadecimal (Hex) code for the 8 bits in each register in the box on the right of each row after the words, "Enter Byte:". **Remember to click the "Write" button to enter the numbers into the registers.**
 - a. Enter the Hex code "0xFE" in the "Enter Byte" box of the PWR row and click the "Write" button. This enables all the basic functions in the MAX1471.
 - b. Click on the FCALA bit in the CONF row and click the "Write" button. This chooses the highest accuracy in calibrating the FSK demodulator.
 - c. Enter the Hex code "0x5F" (for 315 MHz operation) or "0x84" (for 433.92MHz operation) in the "Enter Byte" box of the OSC row and click the "Write" button. This sets the operating frequency of the MAX1471.
 - d. Click on the FCAL bit in the CTRL row, but do not click the "Write" button yet. At this point, the display should look like [Figure 2](#). Notice that the FCAL bit is 1 and the FCALD bit in the STATUS row (near the bottom of the display) is 0.
 - e. Click the "Write" button in the CTRL row. The FCAL bit in the CTRL row will change to 0 and the FCALD bit in the STATUS row will change to 1 (see [Figure 3](#)). This means that the MAX1471 FSK demodulator is calibrated so that the voltage vs. frequency characteristic is centered at the 10.7 MHz IF.
- 8) Connect the RF signal generator to the RF_IN SMA connector. Set the power level out of the generator at –100 dBm with no modulation. Connect an oscilloscope probe to test point TP1, which shows the output of the ASK demodulator. The DC voltage should be about 0.5 to 0.6V. This voltage will vary from about 0.5 to 1.5V as the input RF power is increased from no power to about –65 dBm, then drop abruptly and increase again as the input RF power is increased. The abrupt drop occurs at the point where the automatic gain control (AGC) of the MAX1471 is turned on.

ASK Demodulation

- 9) Return the RF power level to -100 dBm and set up ASK modulation on the RF signal generator. Use a 4.8kHz 50% duty cycle square wave to simulate 4.8kbps Manchester coded data. Set the oscilloscope to AC coupling and set the vertical scale to about 100mV/division. The scope should show a lowpass-filtered square wave whose amplitude increases with increasing RF power. If the RF power is turned off, the scope trace will show a noise voltage with a peak-to-peak value of about 40mV. To estimate the sensitivity, reduce the RF power to a level where the square wave amplitude on the scope is about 1.5 to 2 times the noise voltage. This power level should be somewhere between -111 and -114 dBm if the generator reads the peak power level.
- 10) Move the scope probe to the test point labeled ADATA, change the coupling on the scope back to DC, and set the vertical scale to 1 or 2V/division. You should see a 4.8kHz square wave going from ground to VDD (3.3V in this case). As you increase the RF power, this square wave will be cleaner. Another way to estimate sensitivity from this test point is to reduce the RF power until the square wave becomes extremely asymmetric (duty cycle not 50%) and contains short data transitions (“glitches”) in the middle of a data interval. This power level should be somewhere between -111 and -114 dBm, similar to the level seen in the previous step.

FSK Demodulation

- 11) Return the RF power level to -100 dBm and set up FSK modulation on the RF signal generator. Set the Frequency Deviation to ± 50 kHz. Set the oscilloscope to AC coupling and set the vertical scale to about 100mV/division. Place the scope probe on the test point TP4. The scope should show a 200 to 250mV peak-to-peak lowpass-filtered square wave. Unlike ASK demodulation, the amplitude of the signal at this test point does not change with the RF power. If the RF power is turned off, the scope trace will show a

noise voltage with much higher frequency and amplitude than the 40 mV in the ASK demodulator. These are the “clicks” that characterize the response of an FM demodulator to noise. To estimate the sensitivity, reduce the RF power to a level where the square wave on the scope is noisy but recognizable. This power level should be somewhere between -106 and -109 dBm.

- 12) Move the scope probe to the test point labeled FDATA, change the coupling on the scope back to DC, and set the vertical scale to 1 or 2 V/division. You should see a 4.8kHz square wave going from ground to VDD (3.3 volts in this case). As you increase the RF power, this square wave will be cleaner. Another way to estimate sensitivity from this test point is to reduce the RF power until the square wave becomes extremely asymmetric (duty cycle not 50%) and contains short data transitions (“glitches”) in the middle of a data interval. This power level should be somewhere between -106 and -109 dBm, similar to the level seen in the previous step.

Other Information

After the MAX1471 has been set up with a computer, the computer connection can be removed. The MAX1471 will keep all its settings as long as it has DC power that is not interrupted. When power is turned off and back on again, the MAX1471 needs to be reconfigured.

The FSK Demodulator can be re-calibrated at any time by connecting the MAX1471 to a computer through the MAX1471 software and repeating Steps 7d and 7e above. There is usually no need to re-calibrate if the frequency deviation of the received signal is less than ± 50 kHz. If the ambient temperature changes significantly (more than 40°C) and the received signal has very high frequency deviation, re-calibration may be necessary.

The capacitors in the Sallen-Key data filters (C3 and C4 for ASK, C21 and C22 for FSK) can be changed to set the corner frequencies of these filters if data rates other than 4.8kbps and 12.5kbps are used. See the MAX1471 data sheet for more details.

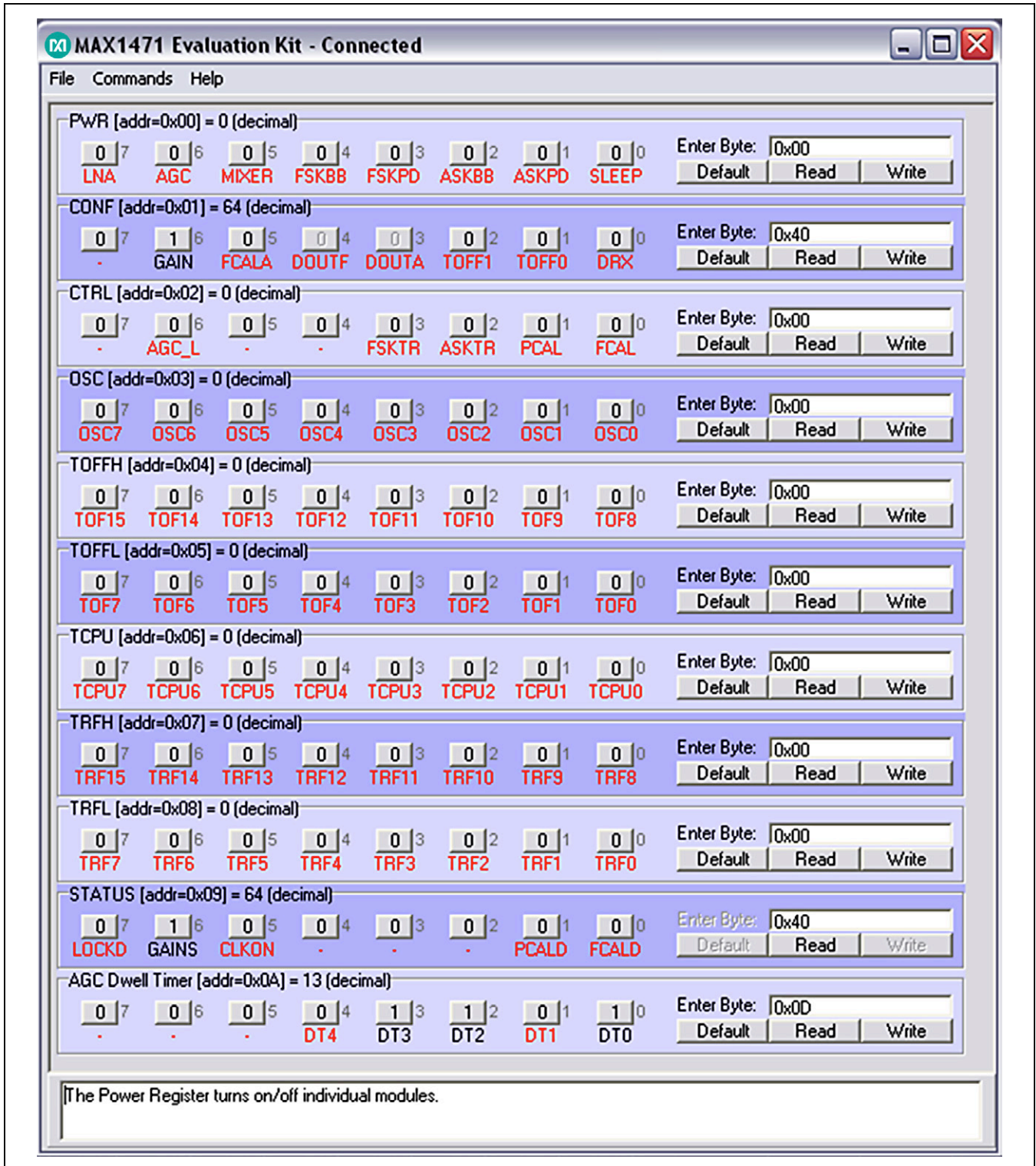

Figure 1. Control Display from MAX1471 Software (Display Immediately After Computer is Connected)

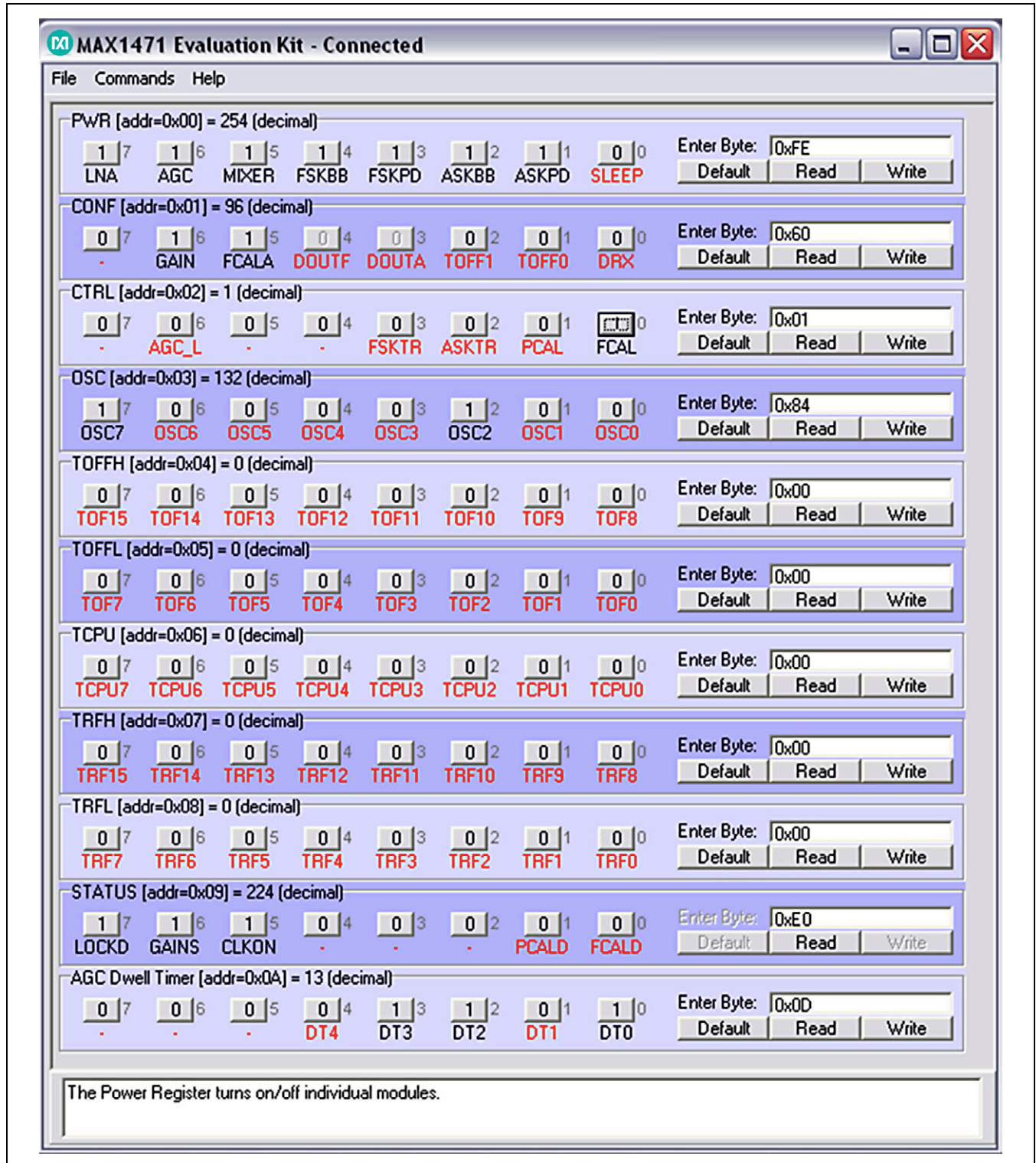

Figure 2. Control Display from MAX1471 Software (Display After PWR, CONF, CTRL, and OSC Rows Have Been Set)

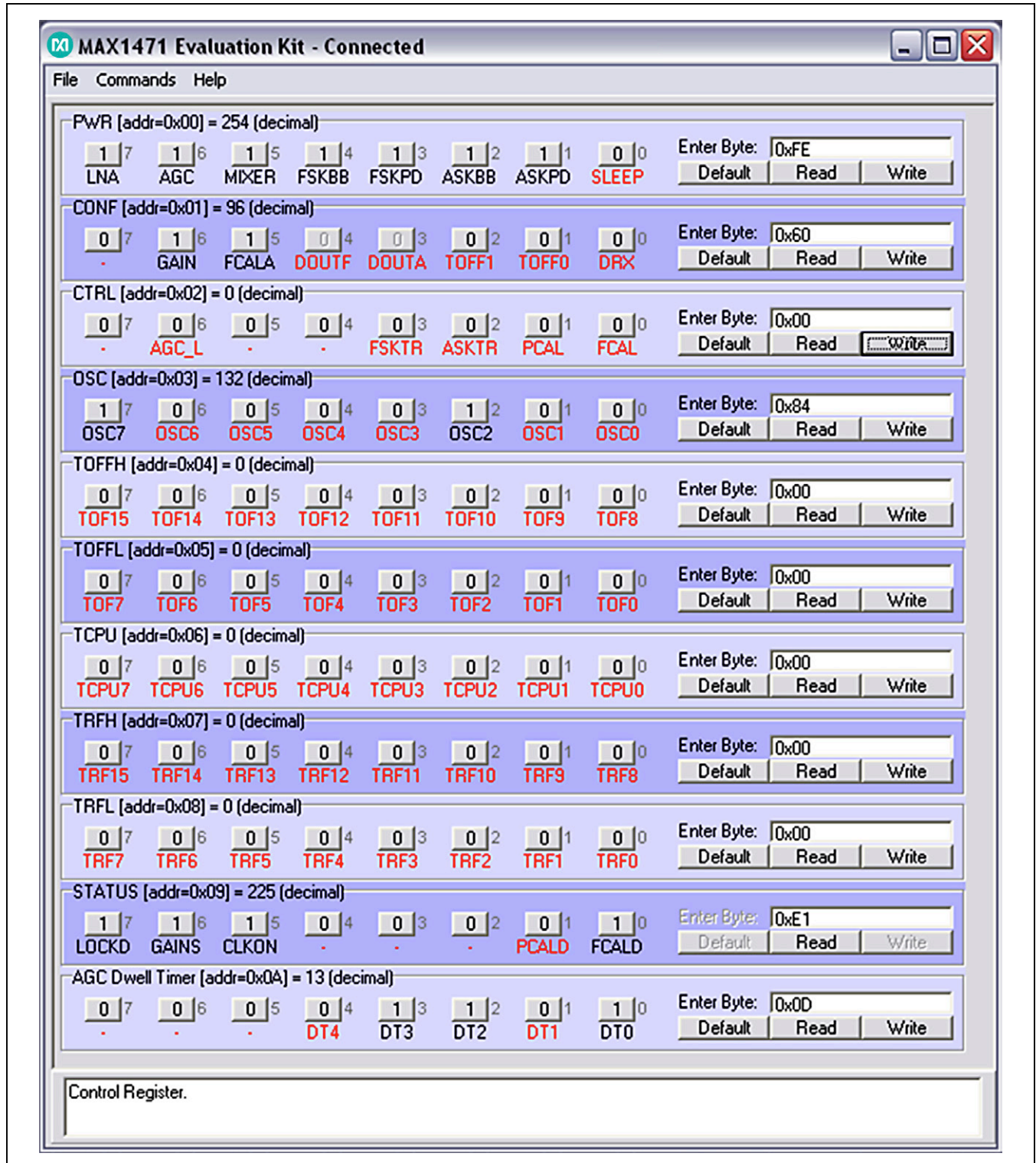

Figure 3. Control Display from MAX1471 Software (Display After Calibration)

Detailed Description of Hardware

Layout Issues

A properly designed PC board is an essential part of any RF/microwave circuit. On high-frequency inputs and outputs, use controlled impedance lines and keep them as short as possible to minimize losses and radiation. At high frequencies, trace lengths that are on the order of $\lambda/10$ or longer can act as antennas.

Keeping the traces short also reduces parasitic inductance. Generally, 1in of a PC board trace adds about 20nH of parasitic inductance. The parasitic inductance can have a dramatic impact on the effective inductance. For example, a 0.5in trace connecting a 100nH inductor adds an extra 10nH of inductance or 10%.

To reduce the parasitic inductance, use wider traces and a solid ground or power plane below the signal traces. Also, use low-inductance connections to ground on all GND pins, and place decoupling capacitors close to all VDD connections.

Power Supply

The MAX1471 can operate from 3.3V or 5V supplies. For 5V operation, remove JU4 before connecting a supply to VDD. For 3.3V operation, connect JU4.

Table 1. Jumper Function Table

JUMPER	STATE	FUNCTION
JU1	1-2	Use Peak Detector for faster receiver startup (ASK)
	2-3	No Peak Detector Operation (ASK)
JU2	1-2	Mixer output to MIX_OUT
	2-3	External IF input
	NC	Normal operation
JU3	1-2	No Peak Detector Operation
	2-3	Use Peak Detector for faster receiver startup (FSK)
JU4	1-2	Connect VDD to +3.3V supply
	NC	Connect VDD to +5.0V supply
JU6	1-2	Normal FSK Data Filter operation. Keep Connected

IF Input / Output

The 10.7MHz IF can be monitored with the help of a spectrum analyzer using the MIX_OUT SMA (not provided). Remove the ceramic filter for such a measurement and include R3 (270Ω) and C17 (0.01μF) to match the 330Ω Mixer output with the 50Ω spectrum analyzer. Jumper JU2 needs to connect pins 1 and 2. It is also possible to use the MIX_OUT SMA to inject an external IF as a means of evaluating the baseband data slicing section. Jumper JU2 will need to connect pins 2 and 3.

F_IN External Frequency Input

For applications where the correct frequency crystal is not available, it is possible to directly inject an external frequency through the F_IN SMA (not provided). Connect the SMA to a function generator. The addition of C18 and C19 is necessary (use 0.01μF capacitors)

Test Points and I/O Connections

Additional test points and I/O connectors are provided to monitor the various baseband signals and for external connections. See [Table 2](#) and [Table 3](#) for a description.

See [Table 1](#) for the jumper function descriptions

For additional information and a list of application notes, consult the www.maximintegrated.com website.

JUMPER	STATE	FUNCTION
JU7	1-2	Normal ASK Data Filter operation. Keep Connected
JU8	1-2	Power to MAX1471 supplied through CMOD Interface board
	N.C.	External Power source required for MAX1471
JU9 JU10 JU11	1-2 N.C. N.C.	ADATA as the serial data output in 4-wire serial interface mode
	N.C. 1-2 N.C.	FDATA as the serial data output in 4-wire serial interface mode
	N.C. N.C. 1-2	3-wire serial interface mode

Table 2. Test Points

TP	DESCRIPTION
1	ASK Data filter feedback node
2	ASK Positive Peak Detector
3	ASK Negative Peak Detector
4	FSK Data filter feedback node
5	FSK Positive Peak Detector
6	FSK Negative Peak Detector
7	IFIN-
FDATA	FSK Data out
ADATA	ASK Data out

Component Suppliers

SUPPLIER	WEBSITE
Murata	http://www.murata.com
Hong Kong Crystal	http://www.hongkongcrystal.com/
Crystek	http://www.crystek.com/

Note: Indicate that you are using the MAX1471 when contacting these component suppliers.

Table 3. I/O Connectors

SIGNAL	DESCRIPTION
RF_IN	RF input
REF_IN	External reference frequency input
MIX_OUT	IF input/output
GND	Ground
VDD	Supply input
J1	5-pin header
J2	CMOD Interface

Ordering Information

PART	TEMP RANGE	IC PACKAGE
MAX1471EVKIT-315	-40°C to +85°C	32-TQFN
MAX1471EVKIT-433	-40°C to +85°C	32-TQFN

MAX1471EV Bill of Materials

PART	QTY	DESCRIPTION
C1, C2, C19, C20, C23, C29, C30, C31, C32, C33	10	0.01 μ F 10% CER CAP (0603) Murata: GRM188R71H103KA01
C3	1	150pF 10% CER CAP (0603) Murata GRM1885C1H151KA01
C4	1	330pF 5% CER CAP (0603) Murata GRM1885C1H331JA01
C5, C27	1	0.047 μ F 10% 50V Cer Cap (0603) Murata: GRM188R71C473K
C6, C26	3	0.1 μ F 10% CER CAP (0603) Murata: GRM188R71C104KA01
C7, C8, C11	3	100pF 5% CER CAP (0603) Murata GRM1885C1H101JA01
C9 (315MHz)	1	2.2pF \pm 0.1pF CER CAP (0603) Murata: GRM1885C1H2R2BZ01
C9 (433MHz)	1	1.0pF \pm 0.1pF CER CAP (0603) Murata: GRM1885C1H1R0BD01
C10	1	220pF 10% CER CAP (0603) Murata GRM1885C1H221KA01
C12	1	1500pF 10% 50V CER CAP (0603) Murata GRM188R71H152K
C13, C16, C17, C18, C24, C25, C28	0	NOT INSTALLED
C14, C15 (315MHz)	2	15pF 5% 50V C0G CER CAP (0603) Murata: GRM1885C1H150J
C14, C15 (433MHz)	2	12pF 5% 50V C0G CER CAP (0603) Murata: GRM1885C1H120J
C21	1	56pF 5% CER CAP (0603) Murata GRM1885C1H560JA01
C22	1	120pF 5% CER CAP (0603) Murata GRM1885C1H121JA01
L1 (315MHz)	1	100nH 5% (0603) Murata LQW18ANR10J00D
L1 (433MHz)	1	56nH 5% (0603) Murata LQW18AN56NJ00D
L2 (315MHz)	1	30nH 5% (0603) Murata LQW18AN30NJ00D
L2 (433MHz)	1	16nH 5% (0603) Murata LQW18AN16NJ00D
L3	1	0 Ω RESISTOR (0603) Any

MAX1471EV Bill of Materials (continued)

PART	QTY	DESCRIPTION
R1, R2, R6, R7	4	100KΩ RESISTOR (0603) Any
R3, R8	2	25KΩ RESISTOR (0603) Any
R4, R5	0	RESISTOR (0603) NOT INSTALLED
RF IN	1	SMA CONNECTOR TOP-MOUNT DIGI-KEY: J500-ND JOHNSON: 142-0701-201
MIX OUT	0	SMA CONNECTOR TOP-MOUNT DIGI-KEY: J500-ND JOHNSON: 142-0701-201 NOT INSTALLED
REF_IN	0	SMA CONNECTOR EDGE-MOUNT JOHNSON: 142-0701-801 NOT INSTALLED
JU1, JU2, JU3	3	3 PIN HEADER Digi-Key S1012-36-ND or Equivalent
JU4, JU6, JU7, JU8, JU9, JU10, JU11	7	2-pin header Digi-Key S1012-36-ND or Equivalent
J1	1	5-pin header Digi-Key S1012-36-ND or Equivalent
J2	1	2X20 RIGHT ANGLE RECEPTACLE SAMTEC SSW-120-02-S-D-RA Methode Electronics RS2R-40-G
	7	SHUNT (JU1) Digi-Key S9000-ND or Equivalent
VDD, GND	2	Test Point Mouser: 151-203 or Equivalent
TP1, TP2, TP3, TP4, TP5, TP6, TP7, FDATA, ADATA	0	NOT INSTALLED
Y1 (315MHz)	1	Crystal 9.509375MHz Crystek 017034
Y1 (433MHz)	1	Crystal 13.225625 MHz Crystek 017035
Y2	1	10.7 MHz Ceramic Filter Murata: SFTLA10M7FA00-B0
U1	1	MAX1471ATJ
U2	1	MAX4729EXT SC70-6
—	1	MAX1471 EVKIT PC Board

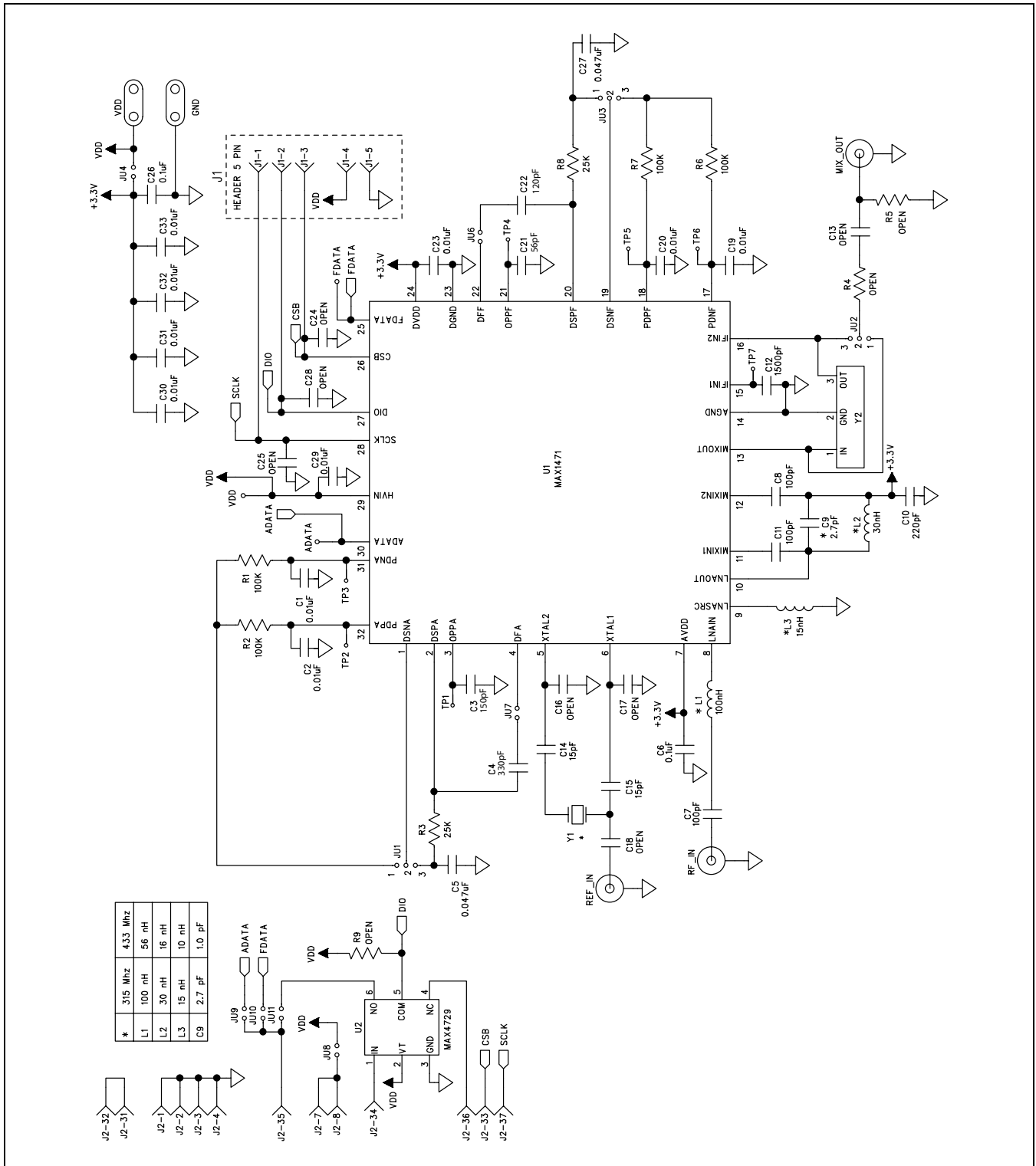

Figure 4. MAX1471 EV Kit Schematic

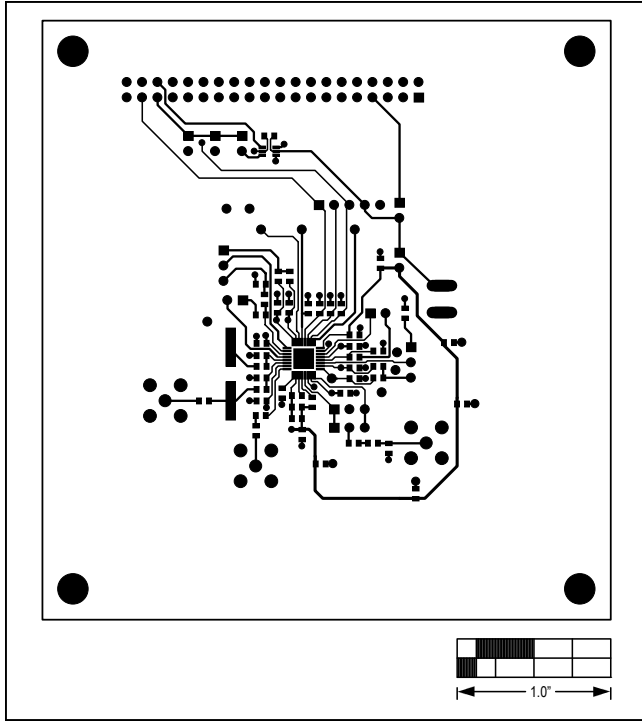

Figure 5. MAX1471 EV Kit Board Layout Component Side

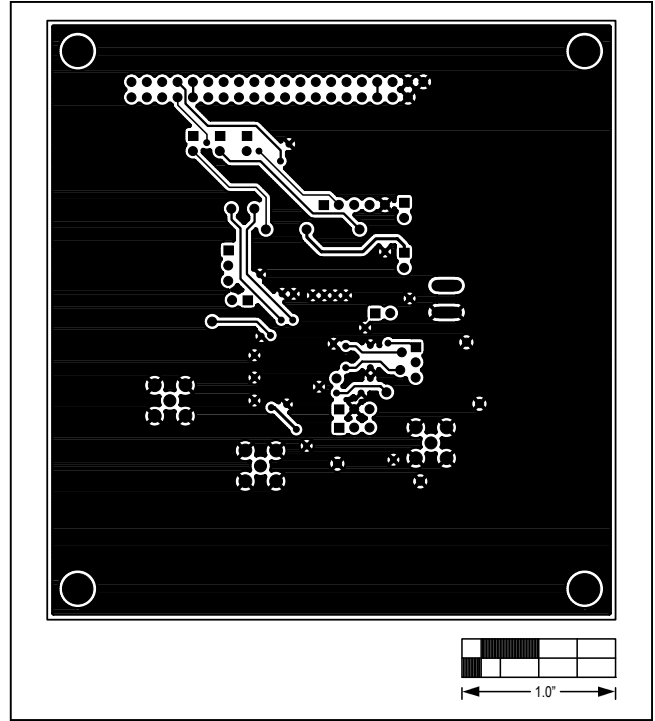

Figure 6. MAX1471 EV Kit Board Layout Solder Side

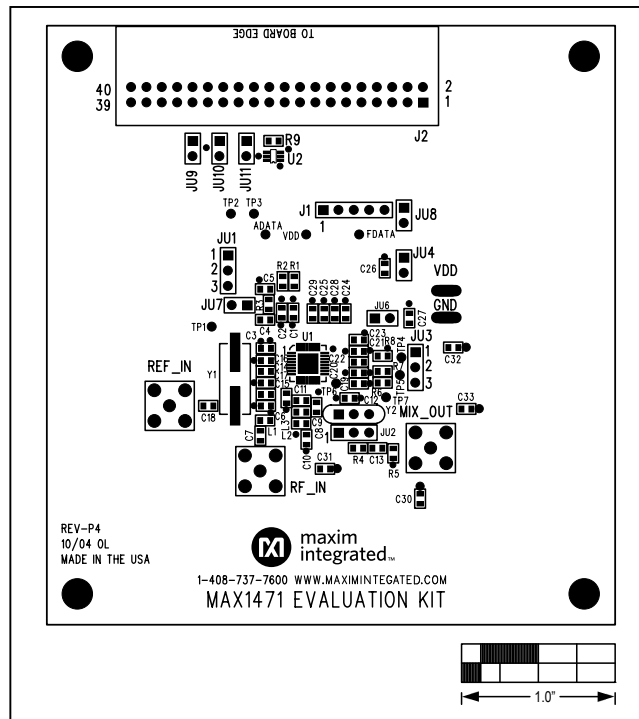

Figure 7. MAX1471 EV Kit Board Layout Component Placement

Revision History

REVISION NUMBER	REVISION DATE	DESCRIPTION	PAGES CHANGED
0	9/16	Initial release	—
1	1/19	Updated <i>ASK Demodulation</i> and <i>Schematic</i>	3, 11

For pricing, delivery, and ordering information, please visit Maxim Integrated's online storefront at <https://www.maximintegrated.com/en/storefront/storefront.html>.

Maxim Integrated cannot assume responsibility for use of any circuitry other than circuitry entirely embodied in a Maxim Integrated product. No circuit patent licenses are implied. Maxim Integrated reserves the right to change the circuitry and specifications without notice at any time.

Компания «Life Electronics» занимается поставками электронных компонентов импортного и отечественного производства от производителей и со складов крупных дистрибьюторов Европы, Америки и Азии.

С конца 2013 года компания активно расширяет линейку поставок компонентов по направлению коаксиальный кабель, кварцевые генераторы и конденсаторы (керамические, пленочные, электролитические), за счёт заключения дистрибьюторских договоров

Мы предлагаем:

- Конкуренспособные цены и скидки постоянным клиентам.
- Специальные условия для постоянных клиентов.
- Подбор аналогов.
- Поставку компонентов в любых объемах, удовлетворяющих вашим потребностям.
- Приемлемые сроки поставки, возможна ускоренная поставка.
- Доставку товара в любую точку России и стран СНГ.
- Комплексную поставку.
- Работу по проектам и поставку образцов.
- Формирование склада под заказчика.
- Сертификаты соответствия на поставляемую продукцию (по желанию клиента).
- Тестирование поставляемой продукции.
- Поставку компонентов, требующих военную и космическую приемку.
- Входной контроль качества.
- Наличие сертификата ISO.

В составе нашей компании организован Конструкторский отдел, призванный помогать разработчикам, и инженерам.

Конструкторский отдел помогает осуществить:

- Регистрацию проекта у производителя компонентов.
- Техническую поддержку проекта.
- Защиту от снятия компонента с производства.
- Оценку стоимости проекта по компонентам.
- Изготовление тестовой платы монтаж и пусконаладочные работы.



Тел: +7 (812) 336 43 04 (многоканальный)

Email: org@lifeelectronics.ru