

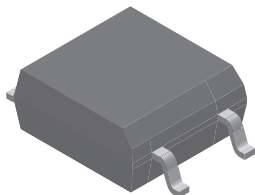

Optocoupler Phototransistor Output, SOP-4, 100 mil Pitch, Mini-Flat Package

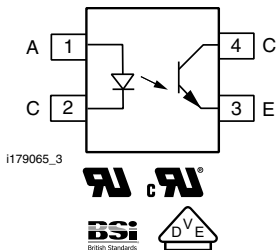

1179066



FEATURES

- SOP (small outline package)
- Isolation test voltage, 3750 V_{RMS} (1 s)
- High collector emitter breakdown voltage, $V_{CEO} = 70$ V
- Low saturation voltage
- Fast switching times
- Temperature stable
- Low coupling capacitance
- End-stackable, 0.100" (2.54 mm) spacing
- Material categorization: For definitions of compliance please see www.vishay.com/doc?99912



DESCRIPTION

The SFH690ABT, SFH690AT, SFH690BT, SFH690CT, SFH690DT family has a GaAs infrared emitting diode emitter, which is optically coupled to a silicon planar phototransistor detector, and is incorporated in a 4 pin 100 mil lead pitch miniflat package. It features a high current transfer ratio, low coupling capacitance, and high isolation voltage.

The coupling devices are designed for signal transmission between two electrically separated circuits. The SFH690 series is available only on tape and reel. There are 2000 parts per reel. Marking for SFH690AT is 690A; SFH690BT is 690B; SFH690CT is 690C; SFH690DT is 690D; SFH690ABT will be marked as 690A or 690B.

APPLICATIONS

- High density mounting or space sensitive PCBs
- PLCs
- Telecommunication

AGENCY APPROVALS

- UL1577, file no. E52744 system code U
- cUL tested to CSA 22.2 bulletin 5A
- BSI IEC 60950; IEC 60065
- DIN EN 60747-5-2 (VDE 0884) available with option 1

ORDERING INFORMATION

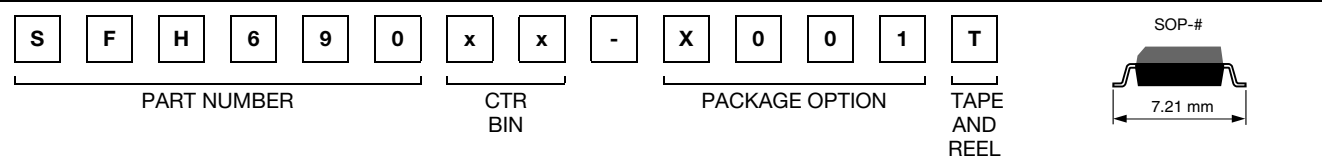

| AGENCY CERTIFIED/PACKAGE | CTR (%) | | | | |
|--------------------------|-----------|---|---|---------------|---------------|
| UL, cUL, BSI | 50 to 300 | 50 to 150 | 100 to 300 | 100 to 200 | 200 to 400 |
| SOP-4, 100 mil pitch | SFH690ABT | SFH690AT3 ⁽¹⁾ , SFH690AT ⁽²⁾ | SFH690BT3 ⁽¹⁾ , SFH690BT ⁽²⁾ | SFH690CT | SFH690DT |
| VDE, UL, cUL, BSI | 50 to 300 | 50 to 150 | 100 to 300 | 100 to 200 | 200 to 400 |
| SOP-4, 100 mil pitch | - | - | SFH690B-X001T | SFH690C-X001T | SFH690D-X001T |

Notes

- (1) Product is rotated 180° in tape and reel cavity
- (2) Also available in tubes, do not put "T" to the end



| ABSOLUTE MAXIMUM RATINGS ($T_{amb} = 25\text{ }^{\circ}\text{C}$, unless otherwise specified) | | | | |
|--|--|------------|----------------|--------------------|
| PARAMETER | TEST CONDITION | SYMBOL | VALUE | UNIT |
| INPUT | | | | |
| Reverse voltage | | V_R | 6 | V |
| DC forward current | | I_F | 50 | mA |
| Surge forward current | $t_p \leq 10\text{ }\mu\text{s}$ | I_{FSM} | 2.5 | A |
| Power dissipation | | P_{diss} | 80 | mW |
| OUTPUT | | | | |
| Collector emitter voltage | | V_{CEO} | 70 | V |
| Emitter collector voltage | | V_{ECO} | 7 | V |
| Collector current | | I_C | 50 | mA |
| | $t_p \leq 1\text{ ms}$ | I_C | 100 | mA |
| Power dissipation | | P_{diss} | 150 | mW |
| COUPLER | | | | |
| Isolation test voltage between emitter and detector (1 s) | | V_{ISO} | 3750 | V_{RMS} |
| Isolation resistance | $V_{IO} = 500\text{ V}, T_{amb} = 25\text{ }^{\circ}\text{C}$ | R_{IO} | $\geq 10^{12}$ | Ω |
| | $V_{IO} = 500\text{ V}, T_{amb} = 100\text{ }^{\circ}\text{C}$ | R_{IO} | $\geq 10^{11}$ | Ω |
| Storage temperature range | | T_{stg} | - 55 to + 150 | $^{\circ}\text{C}$ |
| Ambient temperature range | | T_{amb} | - 55 to + 100 | $^{\circ}\text{C}$ |
| Soldering temperature ⁽¹⁾ | max. 10 s dip soldering distance to seating plane $\geq 1.5\text{ mm}$ | T_{sld} | 260 | $^{\circ}\text{C}$ |

Notes

- Stresses in excess of the absolute maximum ratings can cause permanent damage to the device. Functional operation of the device is not implied at these or any other conditions in excess of those given in the operational sections of this document. Exposure to absolute maximum ratings for extended periods of the time can adversely affect reliability.
- ⁽³⁾ Refer to reflow profile for soldering conditions for surface mounted devices.

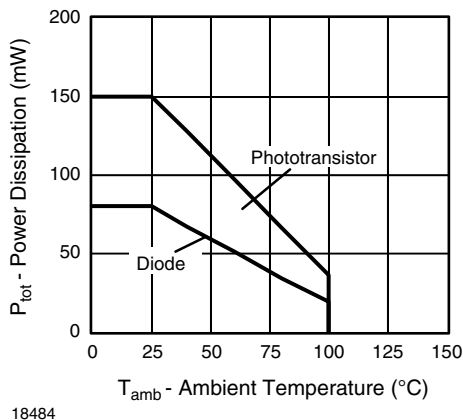

Fig. 1 - Permissible Power Dissipation vs. Ambient Temperature



| ELECTRICAL CHARACTERISTICS (T _{amb} = 25 °C, unless otherwise specified) | | | | | | |
|---|---|--------------------|------|------|------|------|
| PARAMETER | TEST CONDITION | SYMBOL | MIN. | TYP. | MAX. | UNIT |
| INPUT | | | | | | |
| Forward voltage | I _F = 5 mA | V _F | | 1.15 | 1.4 | V |
| Reverse current | V _R = 6 V | I _R | | 0.01 | 10 | μA |
| Capacitance | V _R = 0 V, f = 1 MHz | C _O | | 14 | | pF |
| Thermal resistance | | R _{thJA} | | 750 | | K/W |
| OUTPUT | | | | | | |
| Collector emitter leakage current | V _{CE} = 20 V | I _{CEO} | | | 100 | nA |
| Collector emitter capacitance | V _{CE} = 5 V, f = 1 MHz | C _{CE} | | 2.8 | | pF |
| Thermal resistance | | R _{thJA} | | 500 | | K/W |
| COUPLER | | | | | | |
| Collector emitter saturation voltage | I _F = 10 mA, I _C = 2 mA | V _{CEsat} | | 0.1 | 0.3 | V |
| Coupling capacitance | f = 1 MHz | C _C | | 0.3 | | pF |

Note

- Minimum and maximum values are testing requirements. Typical values are characteristics of the device and are the result of engineering evaluation. Typical values are for information only and are not part of the testing requirements.

| CURRENT TRANSFER RATIO (T _{amb} = 25 °C, unless otherwise specified) | | | | | | | |
|---|--|-----------|--------|------|------|------|------|
| PARAMETER | TEST CONDITION | PART | SYMBOL | MIN. | TYP. | MAX. | UNIT |
| I _C /I _F | I _F = 5 mA, V _{CE} = 5 V | SFH690ABT | CTR | 50 | | 300 | % |
| | | SFH690AT | CTR | 50 | | 150 | % |
| | | SFH690BT | CTR | 100 | | 300 | % |
| | | SFH690CT | CTR | 100 | | 200 | % |
| | | SFH690DT | CTR | 200 | | 400 | % |

| SWITCHING CHARACTERISTICS (T _{amb} = 25 °C, unless otherwise specified) | | | | | | |
|--|--|------------------|------|------|------|------|
| PARAMETER | TEST CONDITION | SYMBOL | MIN. | TYP. | MAX. | UNIT |
| Rise time | I _C = 2 mA, V _{CC} = 5 V, R _L = 100 Ω | t _r | | 3 | | μs |
| Fall time | I _C = 2 mA, V _{CC} = 5 V, R _L = 100 Ω | t _f | | 4 | | μs |
| Turn-on time | I _C = 2 mA, V _{CC} = 5 V, R _L = 100 Ω | t _{on} | | 5 | | μs |
| Turn-off time | I _C = 2 mA, V _{CC} = 5 V, R _L = 100 Ω | t _{off} | | 3 | | μs |

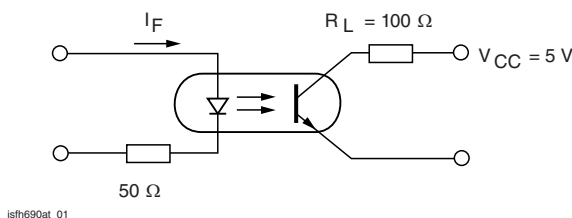

Fig. 2 - Switching Operation (without Saturation)



| SAFETY AND INSULATION RATINGS | | | | | | |
|--|----------------|--------|------|-----------|------|------|
| PARAMETER | TEST CONDITION | SYMBOL | MIN. | TYP. | MAX. | UNIT |
| Climatic classification (according to IEC 68 part 1) | | | | 55/100/21 | | |
| Comparative tracking index | | CTI | 175 | | 399 | |
| V_{IOTM} | | | 6000 | | | V |
| V_{IORM} | | | 707 | | | V |
| P_{SO} | | | | | 350 | mW |
| I_{SI} | | | | | 150 | mA |
| T_{SI} | | | | | 175 | °C |
| Creepage distance | | | 5 | | | mm |
| Clearance distance | | | 5 | | | mm |
| Insulation thickness | | | 0.4 | | | mm |

Note

- As per IEC 60747-5-2, §7.4.3.8.1, this optocoupler is suitable for “safe electrical insulation” only within the safety ratings. Compliance with the safety ratings shall be ensured by means of protective circuits.

TYPICAL CHARACTERISTICS ($T_{amb} = 25\text{ °C}$, unless otherwise specified)

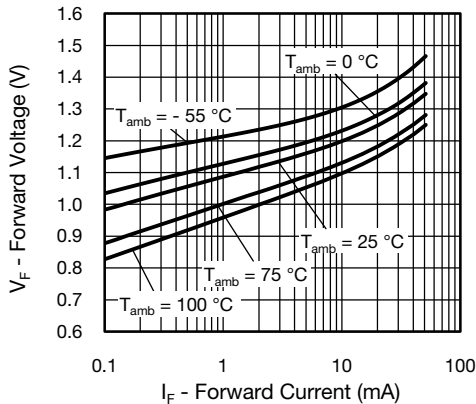

Fig. 3 - Forward Voltage vs. Forward Current

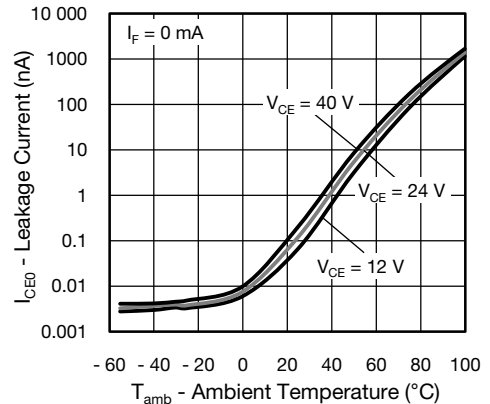

Fig. 5 - Leakage Current vs. Ambient Temperature

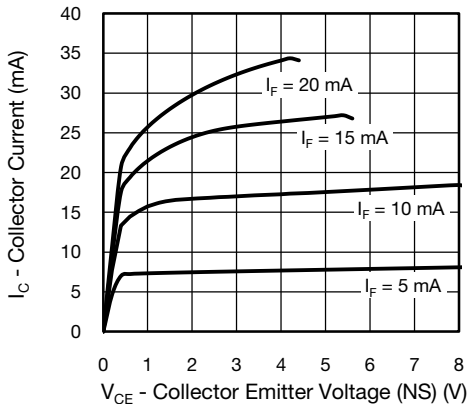

Fig. 4 - Collector Current vs. Collector Emitter Voltage (NS)

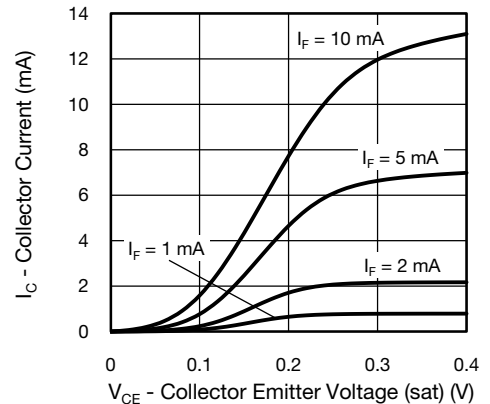

Fig. 6 - Collector Current vs. Collector Emitter Voltage (sat)

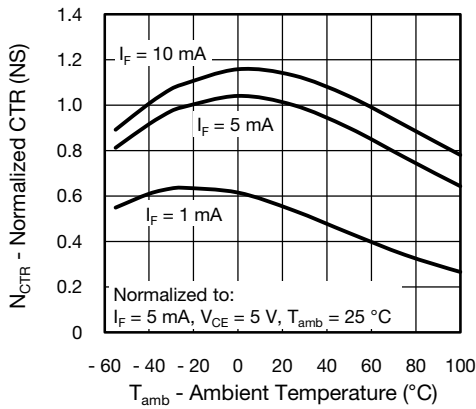

Fig. 7 - Normalized Current Transfer Ratio (sat) vs. Ambient Temperature

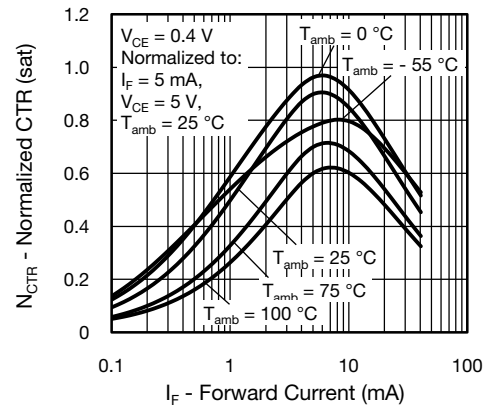

Fig. 10 - Normalized CTR (sat) vs. Forward Current

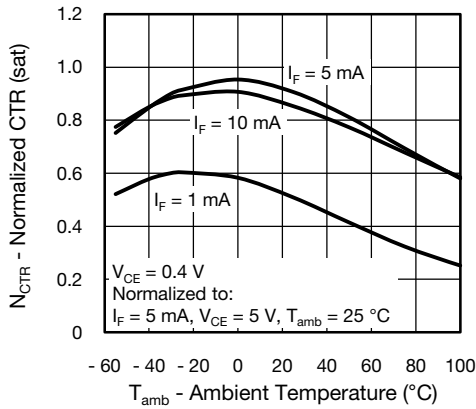

Fig. 8 - Normalized Current Transfer Ratio (NS) vs. Ambient Temperature

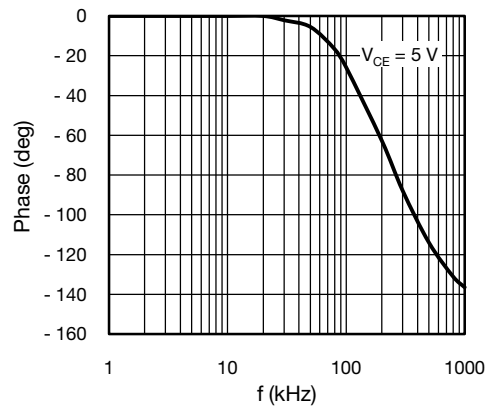

Fig. 11 - F_{CTR} vs. Phase Angle

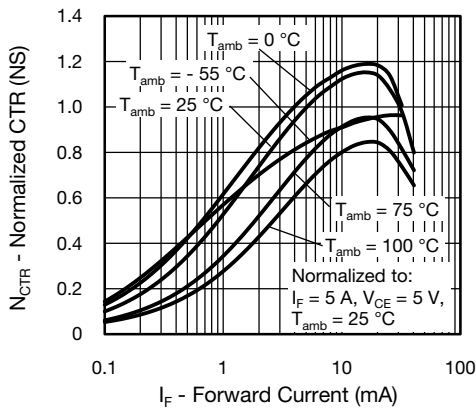

Fig. 9 - Normalized CTR (NS) vs. Forward Current

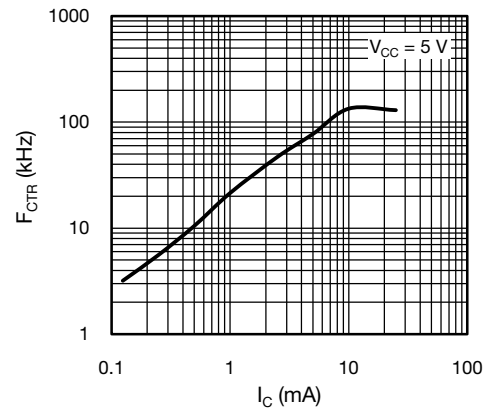

Fig. 12 - F_{CTR} vs. Collector Current

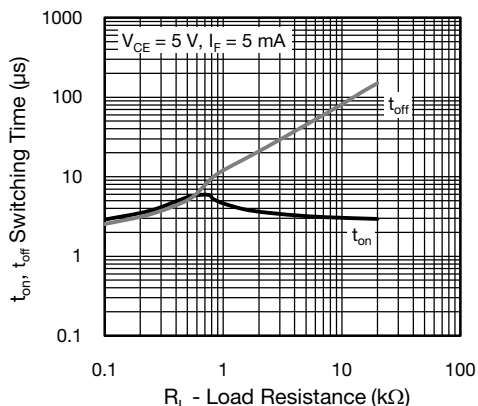
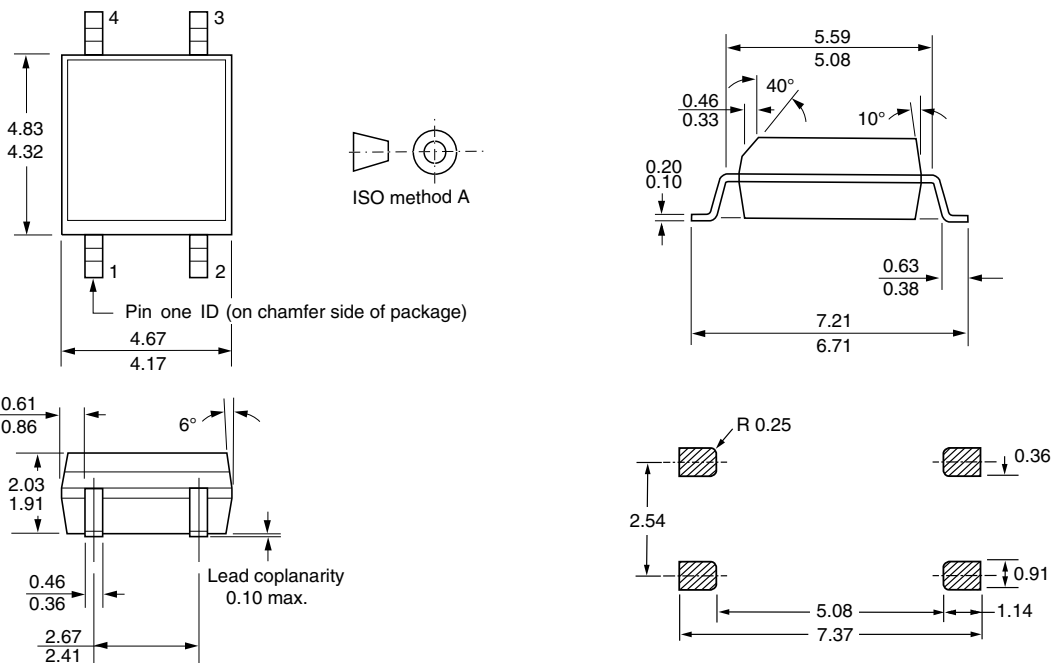

Fig. 13 - Switching Time vs. Load Resistance

PACKAGE DIMENSIONS in millimeters



i178037

PACKAGE MARKING (example of SFH690AT)

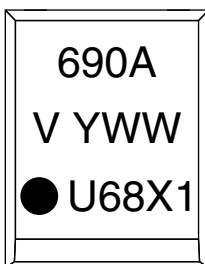

Notes

- Only option 1 is reflected in the package marking with the characters “X1”
- Tape and reel suffix (T) is not part of the package marking



Disclaimer

ALL PRODUCT, PRODUCT SPECIFICATIONS AND DATA ARE SUBJECT TO CHANGE WITHOUT NOTICE TO IMPROVE RELIABILITY, FUNCTION OR DESIGN OR OTHERWISE.

Vishay Intertechnology, Inc., its affiliates, agents, and employees, and all persons acting on its or their behalf (collectively, "Vishay"), disclaim any and all liability for any errors, inaccuracies or incompleteness contained in any datasheet or in any other disclosure relating to any product.

Vishay makes no warranty, representation or guarantee regarding the suitability of the products for any particular purpose or the continuing production of any product. To the maximum extent permitted by applicable law, Vishay disclaims (i) any and all liability arising out of the application or use of any product, (ii) any and all liability, including without limitation special, consequential or incidental damages, and (iii) any and all implied warranties, including warranties of fitness for particular purpose, non-infringement and merchantability.

Statements regarding the suitability of products for certain types of applications are based on Vishay's knowledge of typical requirements that are often placed on Vishay products in generic applications. Such statements are not binding statements about the suitability of products for a particular application. It is the customer's responsibility to validate that a particular product with the properties described in the product specification is suitable for use in a particular application. Parameters provided in datasheets and/or specifications may vary in different applications and performance may vary over time. All operating parameters, including typical parameters, must be validated for each customer application by the customer's technical experts. Product specifications do not expand or otherwise modify Vishay's terms and conditions of purchase, including but not limited to the warranty expressed therein.

Except as expressly indicated in writing, Vishay products are not designed for use in medical, life-saving, or life-sustaining applications or for any other application in which the failure of the Vishay product could result in personal injury or death. Customers using or selling Vishay products not expressly indicated for use in such applications do so at their own risk. Please contact authorized Vishay personnel to obtain written terms and conditions regarding products designed for such applications.

No license, express or implied, by estoppel or otherwise, to any intellectual property rights is granted by this document or by any conduct of Vishay. Product names and markings noted herein may be trademarks of their respective owners.

Material Category Policy

Vishay Intertechnology, Inc. hereby certifies that all its products that are identified as RoHS-Compliant fulfill the definitions and restrictions defined under Directive 2011/65/EU of The European Parliament and of the Council of June 8, 2011 on the restriction of the use of certain hazardous substances in electrical and electronic equipment (EEE) - recast, unless otherwise specified as non-compliant.

Please note that some Vishay documentation may still make reference to RoHS Directive 2002/95/EC. We confirm that all the products identified as being compliant to Directive 2002/95/EC conform to Directive 2011/65/EU.

Vishay Intertechnology, Inc. hereby certifies that all its products that are identified as Halogen-Free follow Halogen-Free requirements as per JEDEC JS709A standards. Please note that some Vishay documentation may still make reference to the IEC 61249-2-21 definition. We confirm that all the products identified as being compliant to IEC 61249-2-21 conform to JEDEC JS709A standards.

Компания «Life Electronics» занимается поставками электронных компонентов импортного и отечественного производства от производителей и со складов крупных дистрибьюторов Европы, Америки и Азии.

С конца 2013 года компания активно расширяет линейку поставок компонентов по направлению коаксиальный кабель, кварцевые генераторы и конденсаторы (керамические, пленочные, электролитические), за счёт заключения дистрибьюторских договоров

Мы предлагаем:

- Конкуренспособные цены и скидки постоянным клиентам.
- Специальные условия для постоянных клиентов.
- Подбор аналогов.
- Поставку компонентов в любых объемах, удовлетворяющих вашим потребностям.
- Приемлемые сроки поставки, возможна ускоренная поставка.
- Доставку товара в любую точку России и стран СНГ.
- Комплексную поставку.
- Работу по проектам и поставку образцов.
- Формирование склада под заказчика.
- Сертификаты соответствия на поставляемую продукцию (по желанию клиента).
- Тестирование поставляемой продукции.
- Поставку компонентов, требующих военную и космическую приемку.
- Входной контроль качества.
- Наличие сертификата ISO.

В составе нашей компании организован Конструкторский отдел, призванный помогать разработчикам, и инженерам.

Конструкторский отдел помогает осуществить:

- Регистрацию проекта у производителя компонентов.
- Техническую поддержку проекта.
- Защиту от снятия компонента с производства.
- Оценку стоимости проекта по компонентам.
- Изготовление тестовой платы монтаж и пусконаладочные работы.



Тел: +7 (812) 336 43 04 (многоканальный)

Email: org@lifeelectronics.ru