

Power Contacts

Type I, Crimp, Snap-In



Pin



Socket

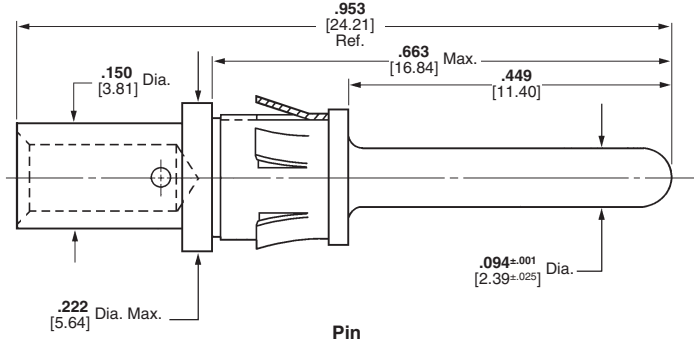

Pin

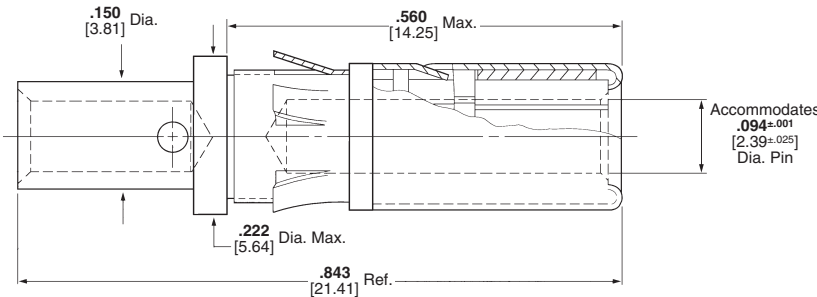

Socket

Material

Contact Body—Bronze
Retention Spring—Beryllium copper

Finish

Contact Body—.000030 [0.00076] gold over .000050 [0.00127] nickel.
 Gold thickness controlled on socket O.D.

Retention Spring—Nickel plated

Related Product Data

Application Tooling—Pages 29, 30

Technical Documents

108-10108 Product Specification
 114-10037 Application Specification

Size 12—Pin Diameter .094 [2.39] (Test Current, 23 Ampere)‡

Wire Size Range		Loose Piece Contact No.		Tooling Part No.	
AWG	[mm ²]	Pin	Socket	Dies for Pneumatic Tool*	Hand Tool
18-16	0.8-1.4	202421-1	202418-1	90122	90121
14-12	2-3	202422-1	202417-1	90122	90121

* Use hand actuated Power Unit **Part No. 189721-2** or foot actuated Power Unit **Part No. 189722-2**. Both units require "C" Head Die Set Adapter **Part No. 318161-1** and an Adapter Holder **Part No. 356304-1** (with ratchet) or **Part No. 189928-1** (without ratchet). Request Catalog 124208 for more information on the 626 Pneumatic Tool System.

‡Single contact, free-air test current; not to be construed as contact rating current. Use only for testing. Refer to contact current carrying capability information, page 3.

Extraction Tool **Part No. 305183-8** (Instruction Sheet 408-1216)

Note: All part numbers are RoHS compliant.

Power Contacts—High Current Upgrade (Continued)

Type II and Type III+, Size 16

The features of the High Current Size 16 contact have been designed to fit into the existing AMP Multimate Connectors such as CPC (Circular Plastic Connector), CMC (Circular Metal Connector), G Series, M Series, Econoseal Metrimate Square Grid and Drawer Connector housings. An initial T-Rise test in free air has shown a 23 amp capability with a 30°C T-Rise. The contact may be crimped onto 14 AWG wire with a Tyco Electronics hand tool P/N 601967-1. Use turret TH502 (1-601967-6) for the pin and turret TH501 (1-601967-5) for the socket.

Material

Pin Body — Leaded Brass; Copper Alloy (Board Mount)

Socket Body — Copper Alloy

Louvertac Band — Beryllium Copper

Retention Spring — Stainless Steel

Finish

Body — Silver

Louvertac Band — Gold

Wire Size AWG	High Current Size 16 Socket Part No.	
	Loose Piece	Tape
14	193846-1	193846-2
18-16	796966-1	796966-2

Wire Size AWG	High Current Size 16 Pin Part No.	
	Loose Piece	Tape
14	193844-1	193844-2
18-16	796964-1	796964-2



4 Pos. CPC Posted Square Flange Receptacle Part No. 796764-1
Mates with CPC Plug (Part No. 206060-1) with either Type II or High Current Socket contact



Extraction Tool Part No. 305183

Current-Carrying Capacity. The graph shows current-carrying capacity versus temperature rise for a fully energized 6 position Metrimate Square Grid plug P/N 207152-1 and receptacle P/N 207153-1. These initial representative ampere ratings were conducted with 14 AWG wires that were 2 feet long.

Current Rating for 30°C Temperature Rise 100% Energized
6 Circuit Metrimate Connector (Wire-to-Wire)

TEMPERATURE RISE VS. CURRENT

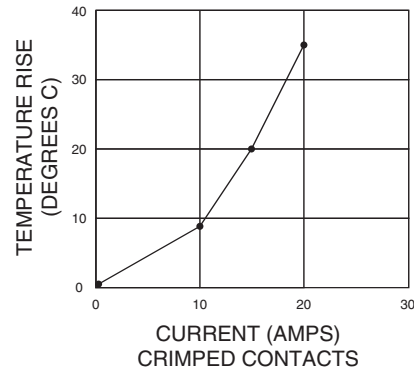

■ **Recognized under the Component Program of Underwriters Laboratories Inc., File No. E28476**

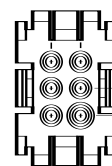
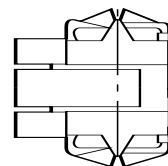
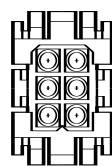
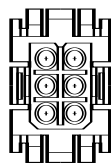
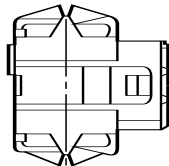
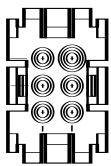

Plug (for Sockets)

Receptacle (for Pins)

- Notes:**
1. High Current contacts with Louvertac bands are NOT intermateable with any other contact.
 2. Additional information on CPC and CMC connectors is available in Catalog 82021.
 3. Additional information on G Series connectors is available in Catalog 82046.
 4. Additional information on M Series connectors is available in Catalog 82003.
 5. Additional information on Metrimate connectors is available in Catalog 82045.
 6. Additional information on Econoseal connectors is available in Catalog 82057.
 7. Additional information on LGH connectors is available in Catalog 82024.

Note: All part numbers are RoHS compliant.

Power Contacts (Continued)

.125 POWERBAND Contacts

Pin Diameter—.125 [3.175]
Test Current—50 Amperes‡

Material and Finish

Contact — Copper
Spring — Beryllium copper
Plating Code
A. 0.00508 [.000200] min. silver on contact area, 0.00127 [.000050] min. on remainder, all over 0.00127 [.000050] min. nickel underplate
B. 0.00076 [.000030] min. gold on contact area, gold flash on remainder, all over 0.00127 [.000050] min. nickel underplate

Related Product Data

Application Tooling—Pages 29, 30
Technical Document—Page 4

Extraction Tool
Part No. 318813-1
(Instruction Sheet 408-4374)



Wire Size AWG/mm ²	Contact Finish	Pin Length	Contact Part No.				Tooling Part No.**	
			Strip		Loose Piece		Heavy Duty Miniature (HDM) Applicators (for AMP-O-LECTRIC Model G Machine, Base Part No. 354500)	Die Sets for Hand Tool 69710-1 or 626 Pneumatic Tool System*
			Pin	Socket	Pin	Socket		
14-12 2-3	A	Standard	213845-1	213847-1	213845-3	213847-3	680195-3	356612-1
	B	Standard	213845-2	213847-2	213845-4	213847-4		
	A	Extended ¹	213845-5	—	213845-7	—		
	B	Extended ¹	213845-6	—	213845-8	—		
10-8 5-8	A	Standard	213841-1	213843-1	213841-3	213843-3	680197-3	356611-1 (8 AWG)
	B	Standard	213841-2	213843-2	213841-4	213843-4		
	A	Extended ¹	213841-5	—	213841-7	—		356611-2 (10 AWG)
	B	Extended ¹	213841-6	—	213841-8	—		

¹For use in Metrimate Drawer Connectors listed in chart below and Two-Piece Sealed Circular Plastic Connectors (CPC), Series 5 and 6.

‡Single contact, free-air test current; not to be construed as contact rating current. Use only for testing.

Refer to contact current carrying capability information, page 3.

Note: Standard Size 8, High Current Size 8 upgrade, and .125 POWERBAND contacts are not interchangeable.

*A typical 626 Pneumatic Tool System requires: a power unit (Part No. 189721-2, hand actuated or 189722-2, foot actuated), an adapter holder (Part No. 356304-1, with ratchet), and "C" Head adapter Part No. 318161-1.

**There are power options available for these tools/dies. See Battery Powered Crimp tool Kit and SDE Electric Terminator on page 30.

Note: All part numbers are RoHS compliant.

.125 POWERBAND Metrimate Drawer Connectors

No. of Pos.	Housing Part No.	
	Plug	Receptacle
8	213886-1**	213500-3**

Color: blue

**For use with .125 POWERBAND contacts (Extended Pin Length), listed above.

Note: All part numbers are RoHS compliant.

Power Contacts (Continued)

**Standard, Size 8,
4/8 Indent Crimp**



Pin



Socket

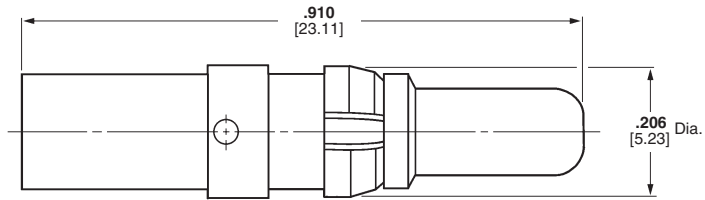

Pin

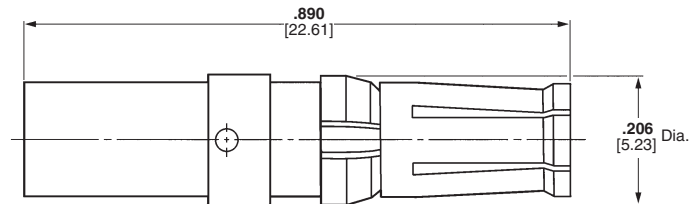

Socket

Note: Standard Size 8, High Current Upgrade Size 8 and .125 POWERBAND contacts are **not** intermateable.

Material

Contact Body—Copper alloy
Retention Clip—Phosphor bronze

Finish

Contact Body—.000050 [0.00127] gold over .000050 [0.00127] nickel
Retention Spring—Nickel plated

Related Product Data

Technical Documents
 108-10045 Product Specification
 114-10014 Application Specification

Power Contacts, Standard, Size 8 (Test Current 50 Amperes)‡

Wire Range		Contacts		Crimping Tools	
AWG	[mm ²]	Pin	Socket	Tool No.	Positioner
18-16	0.8-1.4	213567-1	212014-1	608668-1	(P) SP867 (S) 608668-2
14-12	2-3	213662-1	212008-1	608651-1	(P) SP867 (S) 608651-2
10	5	213740-1	213737-1	608651-1	(P) 608651-3 (S) 608651-2
8	8	213552-2	213750-1	608651-1	(P) 608651-3 (S) 608651-2

‡Single contact, free-air test current; not to be construed as contact rating current. Use only for testing. Refer to contact current carrying capability information, page 3.

Note: All part numbers are RoHS compliant.

Power Contacts—High Current Upgrade (Continued)

Metrimate Drawer Connector, Size 8

The Louvertac bands have the versatility of being designed into contact dimensions used in existing Tyco Electronics connectors.

Metrimate High Current contacts have been designed to fit into the existing Drawer Connector housings. A fully energized 8 position connector with 8 gage wires can handle 30 amps per line with a 30°C T-rise on either the cable-to-cable or cable-to-board.



Cable-to-Cable

Material

- Contact Body** — Copper Alloys
- Louvertac Band** — Beryllium Copper
- Retention Spring** — Stainless Steel
- Finish** — Gold

Product Specification

108-1449 Metrimate Pin and Socket with Louvertac High Current Contact

Connector Voltage Rating — 600 VAC

■ **Recognized under the Component Program of Underwriters Laboratories Inc., File No. E28476**



■ **Certified by Canadian Standards Association, File No. LR7189A**



High Current Contacts

Wire Size AWG	Contact Part Numbers		Crimp Tools
	Pin	Socket	
8	193457-1	193458-1	Daniels† Hand Tool #M310 or AMP P/N 356114-1 Positioner #TP944 or AMP P/N 356336-1
10	193642-1	193643-1	
12-14	193534-1	193535-1	

Extraction Tool Part No. 318813-1 or 305183-6

†Daniels Manufacturing Corp., Orlando, FL
Note: All part numbers are RoHS compliant.

Cable-to-Board

Material

- Contact Body** — Copper Alloys
- Louvertac Band** — Beryllium Copper
- Retention Spring** — Stainless Steel
- Finish** — Gold

A typical application would have solder tail pins mounted into the receptacle and crimp sockets mounted into the plug.

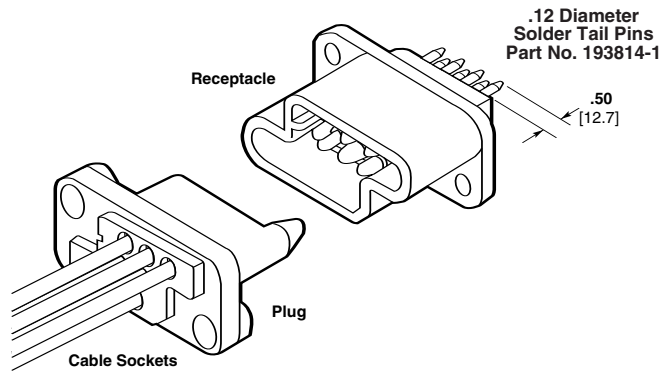

Drawer Connector Housings

Size Configuration	Housing Part Numbers	
	Plug	Receptacle
8 Positions (8 Size 8 Cavities)	213499-1	213500-1
15 Positions (3 Size 8 Cavities & 12 Size 16 Cavities)	213426-1	213427-1

Extraction Tool Part No. 318813-1

Note: All part numbers are RoHS compliant.

Notes: 1. High Current contacts with Louvertac bands are NOT interchangeable with any other contact.
2. Additional information on connectors is available in Catalog 82045.

■ **Recognized under the Component Program of Underwriters Laboratories Inc., File No. E28476**



■ **Certified by Canadian Standards Association, File No. LR7189A**



Power Contacts (Continued)

Type XII, Precision Formed, Crimp, Snap-In

Material

Copper

Finish

- A—Tin-lead
- B—.000030 [0.00076] selective gold over .000030 [0.00076] nickel
- C—.000100 [0.00254] silver plated contacts with lubricant added

Test Current Rating

Silver or Gold—35 amperes ‡

Tin Lead—15 amperes ‡

‡Single contact, free-air test current; not to be construed as contact rating current. Use only for testing. Refer to contact current carrying capability information, page 3.

Related Product Data

Application Tooling—Pages 29, 30

Technical Documents—Page 4



Male



Female

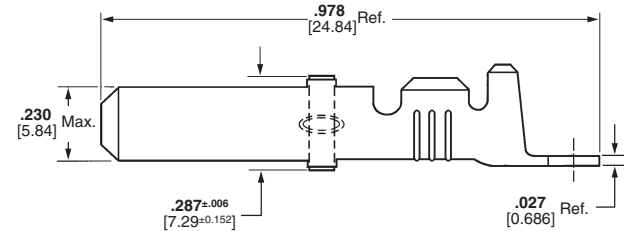
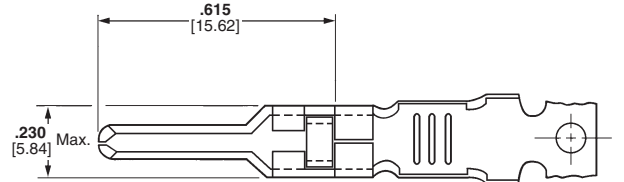

Male

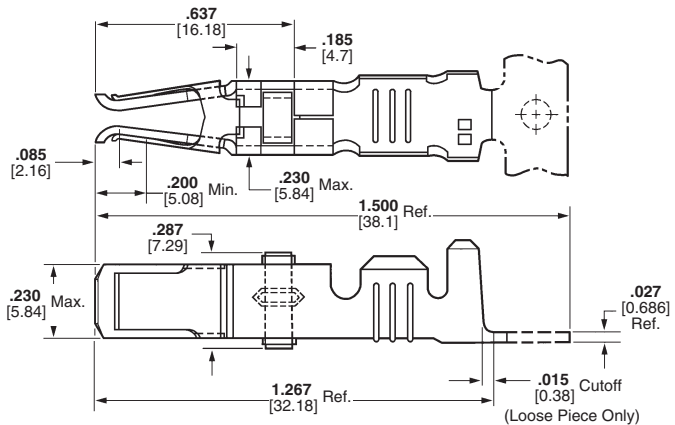

Female

Extraction Tool Part No. 91019-3

Wire Size Range ¹	Ins. Dia. Range	Contact Finish	Strip Form Contact Part Nos.				Loose Piece		Tooling**		
			Standard***		Heavy Duty Miniature***		Contact Part Nos.		Heavy Duty Miniature Applicator	Die Set for Hand Tool 69710-1 or 626 Pneumatic Tool System	
AWG	mm ²		Male	Female	Male	Female	Male	Female			
16 and 14-12	1.25-1.4 and 2-3	.135-.160 3.43-4.06	A	66255-1♦	66740-7♦	66255-5♦	1-66740-2♦	66261-1♦	66740-8♦	567455-□***♦	90145-2 ^{3,7} ♦ and 90145-1 ^{4,7} ♦
				66256-1 ² ♦	—	66256-5 ² ♦	—	66262-1 ² ♦	—		
			B	66255-2♦	66740-5♦	66255-6♦	1-66740-1♦	66261-2♦	66740-6♦		
				66256-2 ² ♦	—	66256-4 ² ♦	—	66262-2 ² ♦	—		
			C ⁵	66255-7♦	66740-1♦	66255-8♦	66740-9♦	66261-4♦	66740-2♦		
				66256-6 ² ♦	—	66256-7 ² ♦	—	66262-4 ² ♦	—		
10	5-6	.190-.220 4.83-5.59	A	66253-1♦	66741-7♦	66253-5♦	1-66741-2♦	66259-1♦	66741-8♦	567021-□***♦	90140-17♦
				66254-1 ² ♦	—	—	—	66260-1 ² ♦	—		
			B	66253-2♦	66741-5♦	66253-6♦	1-66741-1♦	66259-2♦	66741-6♦		
				66254-2 ² ♦	—	66254-5♦	—	66260-2 ² ♦	—		
			C ⁵	66253-4♦	66741-1♦	66253-8♦	66741-9♦	66259-4♦	66741-2♦		
				66254-4 ² ♦	—	—	—	66260-4 ² ♦	—		

¹Wire strip length—.281 [7.14].

²Ground contact.

³Die insert **Part No. 90145-2** is for crimping 16 AWG [1.25-1.4 mm²] wire.

⁴Die insert **Part No. 90145-1** is for crimping 14-12 AWG [2-3 mm²] wire.

⁵Recommended for high current/vibration applications where fretting corrosion is a problem.

⁷Die Set requires "C" Head Adapter **Part No. 318161-1**; Adapter Holder **Part No. 356304-1** (with ratchet) or **189928-1** (without); and Power Unit **Part No. 189721-2** (hand actuated) or **189722-2** (foot actuated).

Extraction Tool Part No. 91019-3

**There are power options available for these tools/dies. See Battery Powered Crimp tool Kit and SDE Electric Terminator on page 30.

***Call Technical Support at 1-800-522-6752 for Automatic Machine Applicator Part Numbers.

Note: All part numbers are RoHS compliant except: ♦ Indicates non-RoHS compliant.

Power Contacts—High Current Upgrade (Continued)

Type XII, Screw Machined

The features of the High Current Type XII contact have been designed to fit into the existing AMP Multimate Connectors such as CPC (Circular Plastic Connector), CMC (Circular Metal Connector), G Series, and M Series housings. An initial T-Rise test in free air has shown a 60 amp capability with a 30°C T-Rise with 8 gage wires. The contact may be crimped onto 8 AWG wire with a Daniels Hand Tool M310 or AMP P/N 356114-1 and Positioner TP1068S or AMP P/N 356119-1.

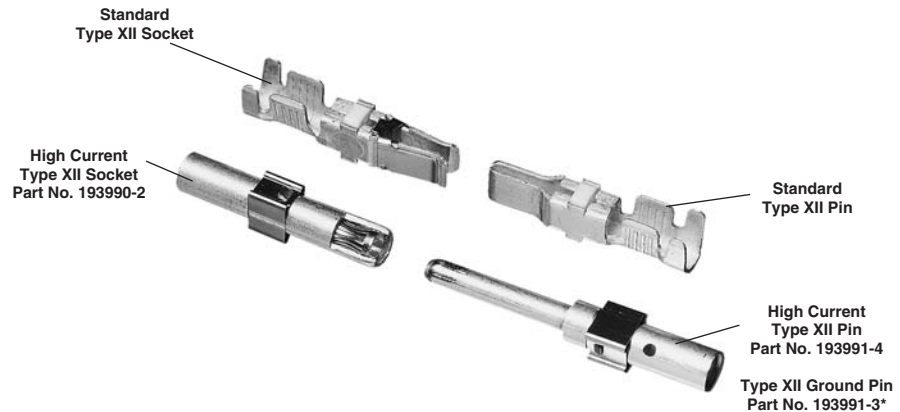

* Not recommended for CPC connectors.

Cable-to-Cable

Material

Body — Copper Alloy

Louvertac Band — Beryllium Copper

Retention Spring — Stainless Steel

Finish

Body — Silver

Louvertac Band — Gold



Extraction Tool Part No. 224155-1

Current-Carrying Capacity. The graph shows current-carrying capacity versus temperature rise for a fully energized 3 position CPC plug P/N 206037-2 and receptacle P/N 206036-2. These initial representative amperage ratings were conducted with 8 AWG wires that were 3 feet long.

■ **Recognized under the Component Program of Underwriters Laboratories Inc.,**  **File No. E28476**

Current Rating for 30°C Temperature Rise 100% Energized

3 Circuit Connector (Wire-to-Wire)

TEMPERATURE RISE VS CURRENT

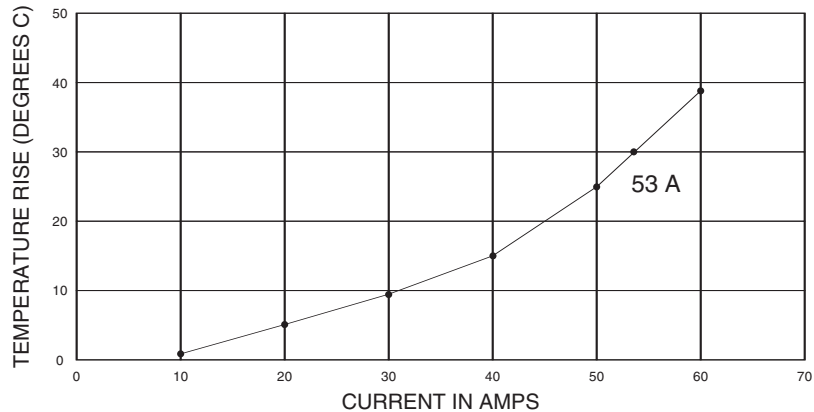

Plug
(For Sockets)



Square Flange Receptacle
(For Pins)

Notes: 1. High Current contacts with Louvertac bands are NOT intermateable with any other contact.

2. Additional information on CPC and CMC connectors is available in Catalog 82021.

3. Additional information on G Series connectors is available in Catalog 82046.

4. Additional information on M Series connectors is available in Catalog 82003.

5. Additional information on LGH connectors is available in Catalog 82024.

Note: All part numbers are RoHS compliant.

Компания «Life Electronics» занимается поставками электронных компонентов импортного и отечественного производства от производителей и со складов крупных дистрибьюторов Европы, Америки и Азии.

С конца 2013 года компания активно расширяет линейку поставок компонентов по направлению коаксиальный кабель, кварцевые генераторы и конденсаторы (керамические, пленочные, электролитические), за счёт заключения дистрибьюторских договоров

Мы предлагаем:

- Конкурентоспособные цены и скидки постоянным клиентам.
- Специальные условия для постоянных клиентов.
- Подбор аналогов.
- Поставку компонентов в любых объемах, удовлетворяющих вашим потребностям.
- Приемлемые сроки поставки, возможна ускоренная поставка.
- Доставку товара в любую точку России и стран СНГ.
- Комплексную поставку.
- Работу по проектам и поставку образцов.
- Формирование склада под заказчика.
- Сертификаты соответствия на поставляемую продукцию (по желанию клиента).
- Тестирование поставляемой продукции.
- Поставку компонентов, требующих военную и космическую приемку.
- Входной контроль качества.
- Наличие сертификата ISO.

В составе нашей компании организован Конструкторский отдел, призванный помогать разработчикам, и инженерам.

Конструкторский отдел помогает осуществить:

- Регистрацию проекта у производителя компонентов.
- Техническую поддержку проекта.
- Защиту от снятия компонента с производства.
- Оценку стоимости проекта по компонентам.
- Изготовление тестовой платы монтаж и пусконаладочные работы.



Тел: +7 (812) 336 43 04 (многоканальный)

Email: org@lifeelectronics.ru