

High temperature 20 A SCRs

Datasheet - production data

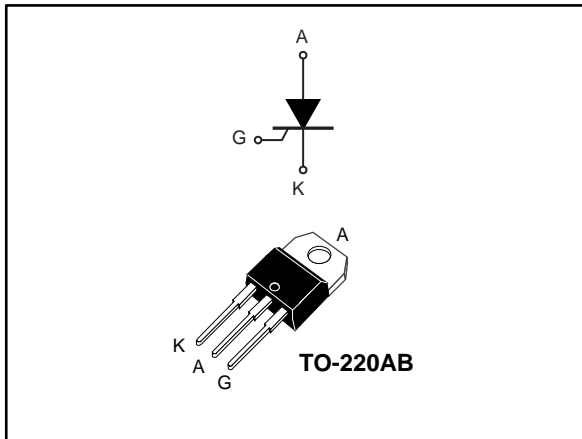

Description

Packaged in a non-isolated TO-220AB, this device offers high thermal performance during operation of up to 20 A_{RMS}, thanks to a junction temperature of up to 150 °C.

The combination of noise immunity and low gate triggering current allows to design strong and compact control circuit.

Table 1: Device summary

| Order code | Package | V _{DRM} /V _{RRM} | I _{GT} |
|------------|----------|------------------------------------|-----------------|
| TN2010H-6T | TO-220AB | 600 V | 10 mA |

Features

- High junction temperature: T_j = 150 °C
- High noise immunity dV/dt = 400 V/μs up to 150 °C
- Gate triggering current I_{GT} = 10 mA
- Peak off-state voltage V_{DRM}/V_{RRM} = 600 V
- High turn on current rise dI/dt = 100 A/μs
- ECOPACK®2 compliant component

Applications

- Motorbike voltage regulator circuits
- Inrush current limiting circuits
- Motor control circuits and starters
- Light dimmers
- Solid state relays

1 Characteristics

Table 2: Absolute maximum ratings (limiting values), $T_j = 25\text{ °C}$ unless otherwise specified

| Symbol | Parameter | | Value | Unit |
|-------------------|---|-------------------------|-----------------------|-----------|
| $I_{T(RMS)}$ | RMS on-state current (180 ° conduction angle) | $T_c = 132\text{ °C}$ | 20 | A |
| $I_{T(AV)}$ | Average on-state current (180 ° conduction angle) | $T_c = 132\text{ °C}$ | 12.7 | A |
| | | $T_c = 137\text{ °C}$ | 10 | |
| | | $T_c = 140\text{ °C}$ | 8 | |
| I_{TSM} | Non repetitive surge peak on-state current (T_j initial = 25 °C) | $t_p = 8.3\text{ ms}$ | 197 | A |
| | | $t_p = 10\text{ ms}$ | 180 | |
| I^2t | I^2t value for fusing | $t_p = 10\text{ ms}$ | 162 | A^2s |
| di/dt | Critical rate of rise of on-state current $I_G = 2 \times I_{GT}$, $t_r \leq 100\text{ ns}$ | $f = 60\text{ Hz}$ | 100 | $A/\mu s$ |
| V_{DSM}/V_{RSM} | Non repetitive surge peak off-state voltage | $t_p = 10\text{ ms}$ | 700 | V |
| I_{GM} | Peak gate current | $t_p = 20\text{ }\mu s$ | $T_j = 150\text{ °C}$ | A |
| $P_{G(AV)}$ | Average gate power dissipation | $T_j = 150\text{ °C}$ | 1 | W |
| V_{RGM} | Maximum peak reverse gate voltage | | 5 | V |
| T_{stg} | Storage junction temperature range | | -40 to +150 | °C |
| T_j | Operating junction temperature range | | -40 to +150 | °C |
| T_L | Maximum lead temperature for soldering during 10 s | | 260 | °C |

Table 3: Electrical characteristics ($T_j = 25\text{ °C}$ unless otherwise specified)

| Symbol | Test conditions | | Value | Unit | |
|----------|--|-----------------------|-------|------|-----------|
| I_{GT} | $V_D = 12\text{ V}$, $R_L = 33\text{ }\Omega$ | Typ. | 5 | mA | |
| | | Max. | 10 | | |
| V_{GT} | | Max. | 1.3 | V | |
| V_{GD} | $V_D = V_{DRM}$, $R_L = 3.3\text{ k}\Omega$ | $T_j = 150\text{ °C}$ | Min. | 0.1 | V |
| I_H | $I_T = 500\text{ mA}$, gate open | | Max. | 40 | mA |
| I_L | $I_G = 1.2 \times I_{GT}$ | | Max. | 60 | mA |
| dV/dt | $V_D = 402\text{ V}$, gate open | $T_j = 150\text{ °C}$ | Min. | 400 | $V/\mu s$ |
| t_{gt} | $I_{TM} = 40\text{ A}$, $V_D = 402\text{ V}$, $I_G = 20\text{ mA}$, $(di/dt)_{max} = 0.2\text{ A}/\mu s$ | | Typ. | 1.9 | μs |
| t_q | $I_{TM} = 40\text{ A}$, $V_D = 402\text{ V}$, $(di/dt)_{off} = 30\text{ A}/\mu s$, $V_R = 25\text{ V}$, $dV_D/dt = 40\text{ V}/\mu s$ | $T_j = 150\text{ °C}$ | Typ. | 70 | μs |

Table 4: Static characteristics

| Symbol | Test conditions | | | Value | Unit |
|-----------------------|---|------------------------------------|------|-------|---------------|
| V_{TM} | $I_{TM} = 40 \text{ A}$, $t_p = 380 \mu\text{s}$ | $T_j = 25 \text{ }^\circ\text{C}$ | Max. | 1.6 | V |
| V_{TO} | Threshold voltage | $T_j = 150 \text{ }^\circ\text{C}$ | Max. | 0.82 | |
| R_D | Dynamic resistance | $T_j = 150 \text{ }^\circ\text{C}$ | Max. | 17.5 | m Ω |
| I_{DRM} , I_{RRM} | $V_D = V_{DRM}$, $V_R = V_{RRM}$ | $T_j = 25 \text{ }^\circ\text{C}$ | Max. | 5 | μA |
| | | $T_j = 125 \text{ }^\circ\text{C}$ | | 2 | mA |
| | | $T_j = 150 \text{ }^\circ\text{C}$ | | 3.9 | |

Table 5: Thermal parameters

| Symbol | Parameter | | Value | Unit |
|---------------|--------------------------|------|-------|--------------------|
| $R_{th(j-c)}$ | Junction to case (DC) | Max. | 1.0 | $^\circ\text{C/W}$ |
| $R_{th(j-a)}$ | Junction to ambient (DC) | Typ. | 60 | |

1.1 Characteristics (curves)

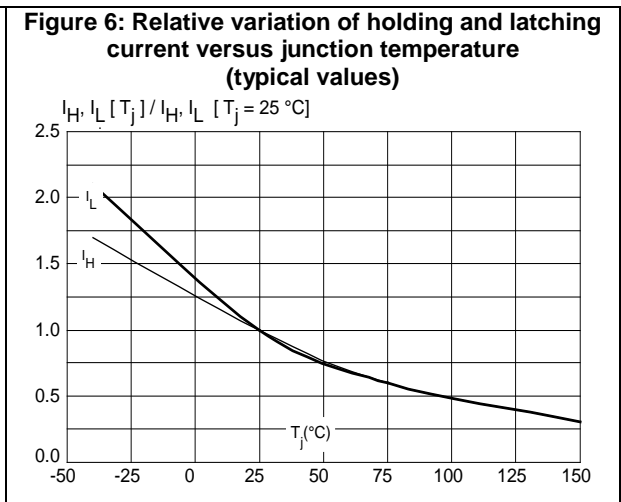
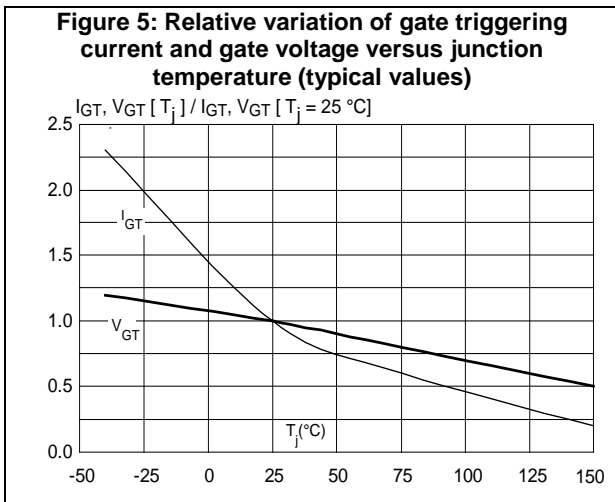
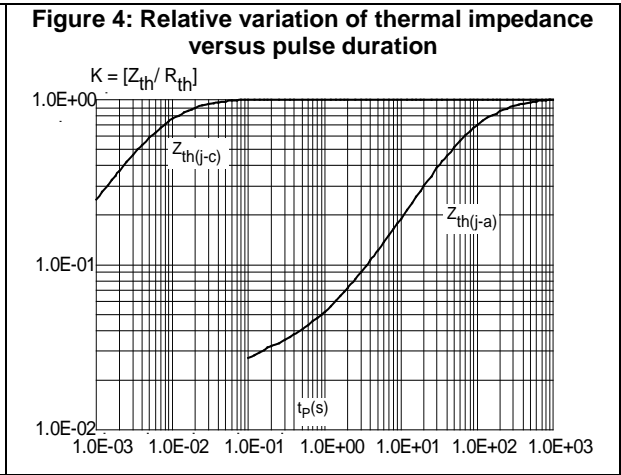
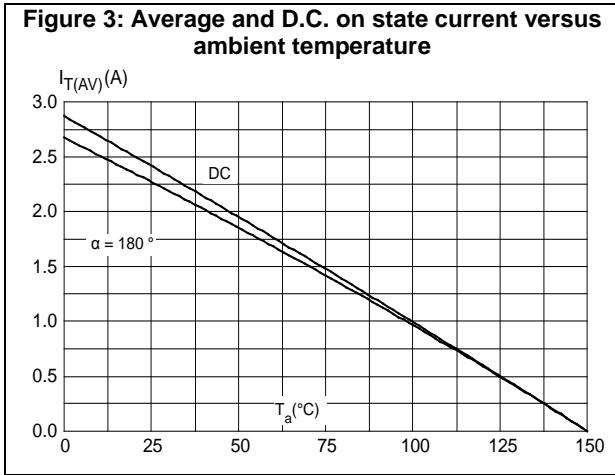
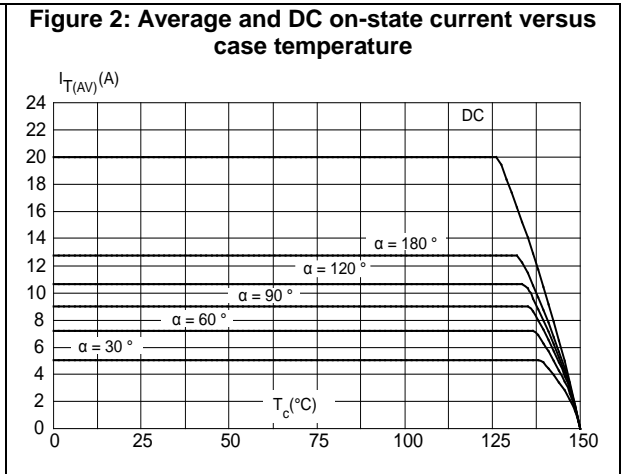
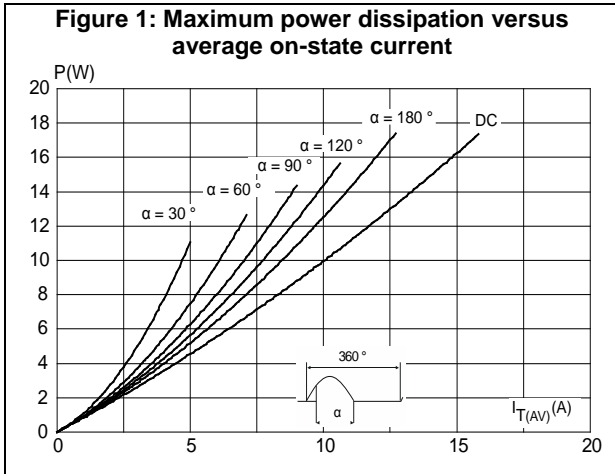

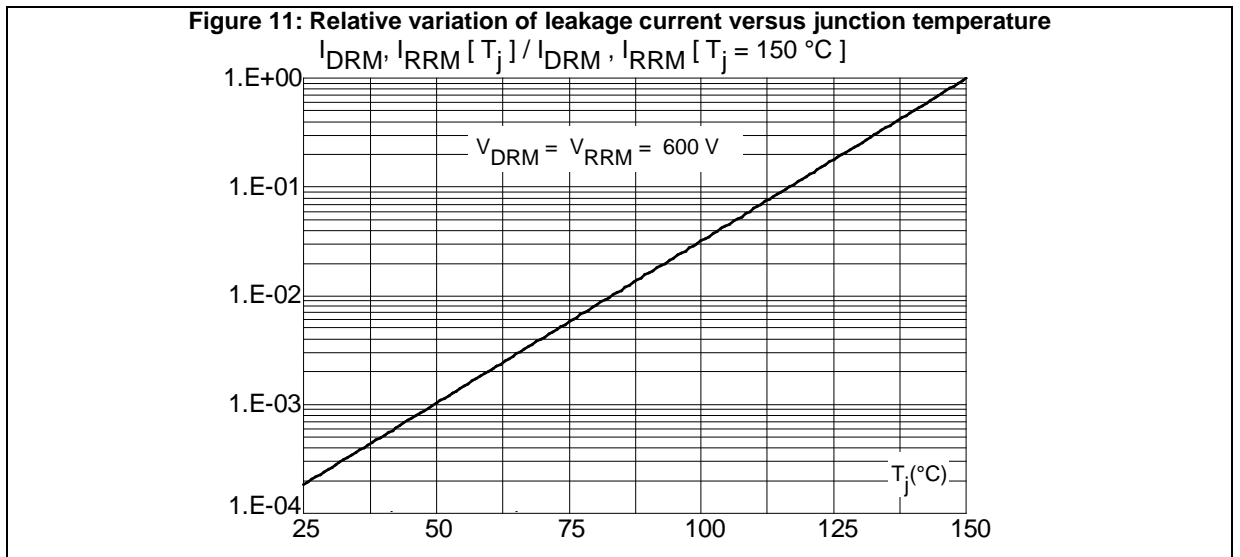
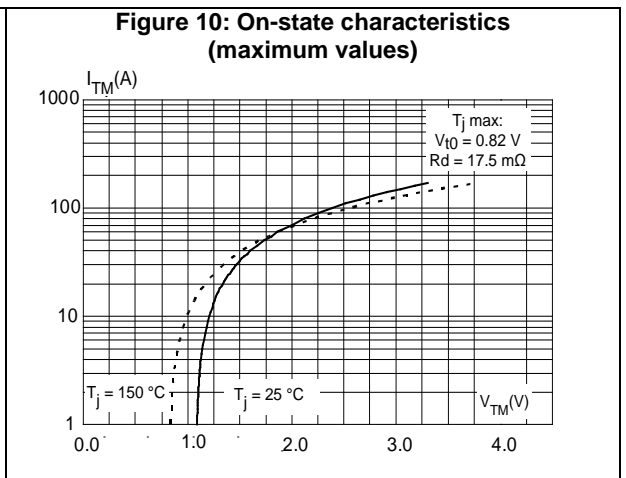
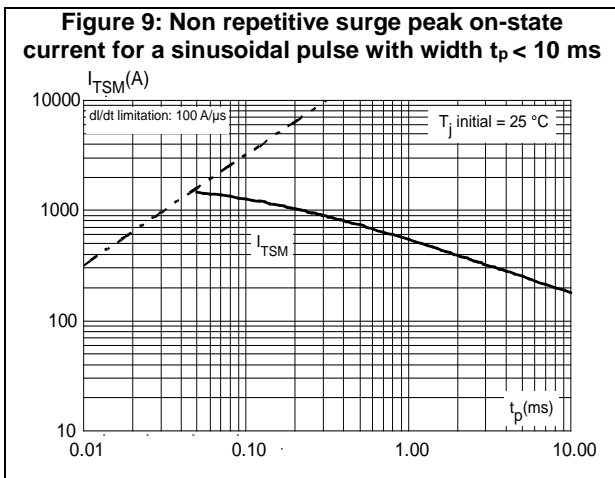
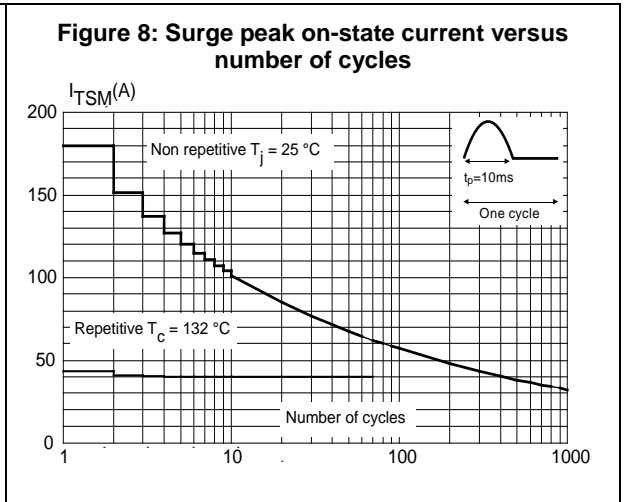
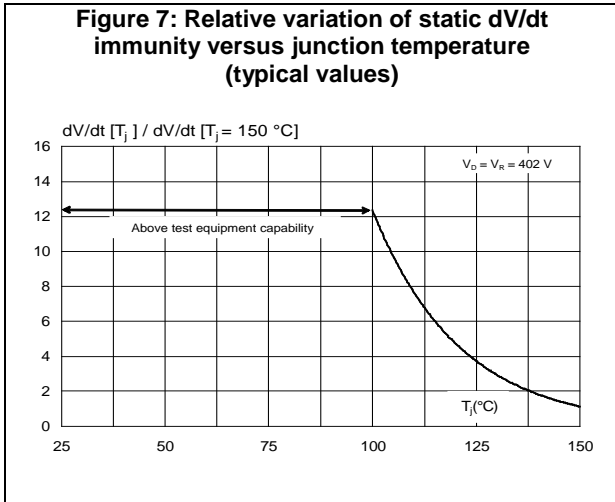

2 Package information

In order to meet environmental requirements, ST offers these devices in different grades of ECOPACK® packages, depending on their level of environmental compliance. ECOPACK® specifications, grade definitions and product status are available at: www.st.com. ECOPACK® is an ST trademark.

- Epoxy meets UL94, V0
- Lead-free, halogen-free package
- Recommended torque value (TO-220AB): 0.4 to 0.6 N.m

2.1 TO-220AB package information

Figure 12: TO-220AB (NIns.) package outline

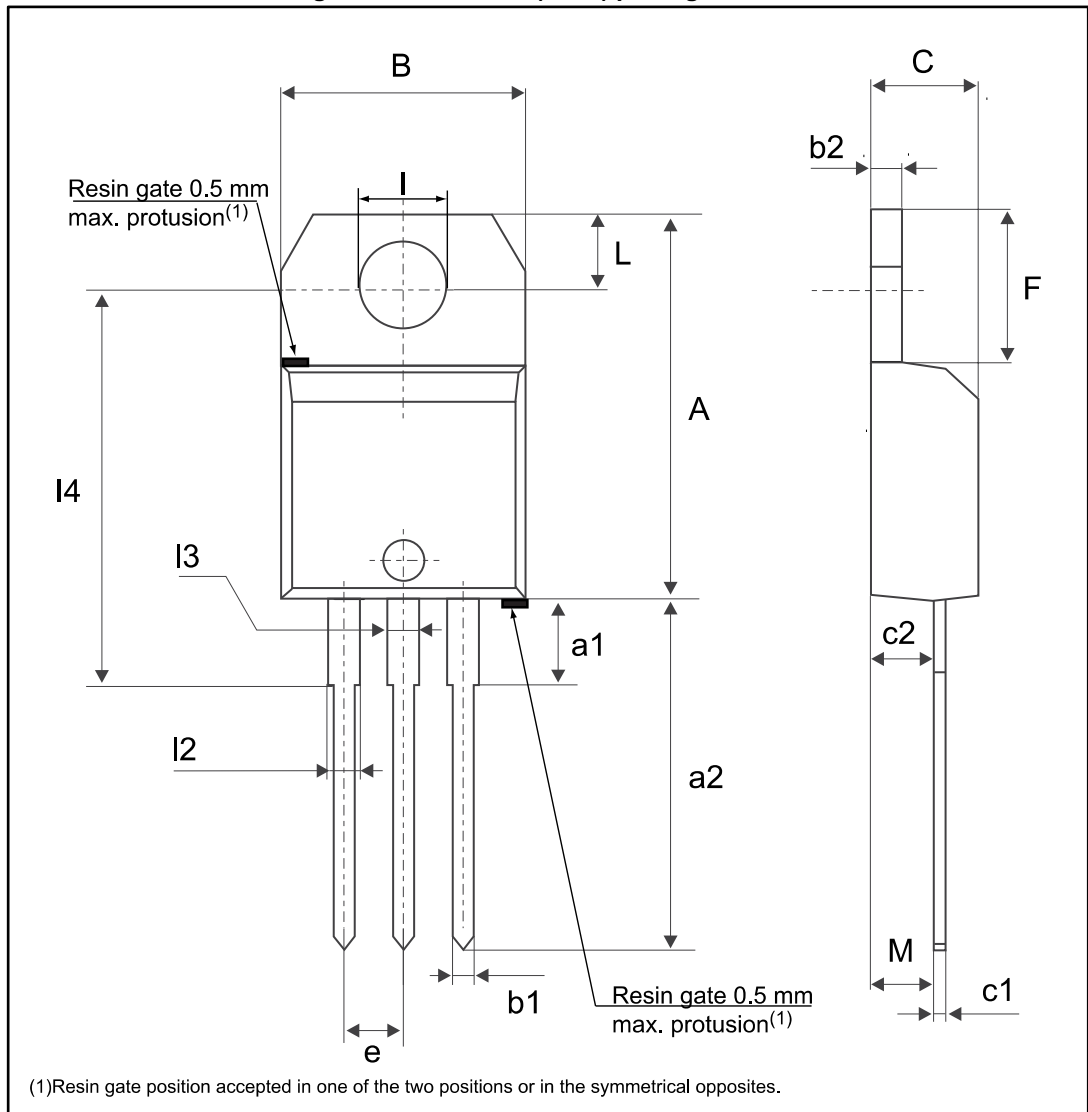

Table 6: TO-220AB (Nlns.) package mechanical data

| Ref. | Dimensions | | | | | |
|------|-------------|-------|-------|-----------------------|--------|--------|
| | Millimeters | | | Inches ⁽¹⁾ | | |
| | Min. | Typ. | Max. | Min. | Typ. | Max. |
| A | 15.20 | | 15.90 | 0.5984 | | 0.6260 |
| a1 | | 3.75 | | | 0.1476 | |
| a2 | 13.00 | | 14.00 | 0.5118 | | 0.5512 |
| B | 10.00 | | 10.40 | 0.3937 | | 0.4094 |
| b1 | 0.61 | | 0.88 | 0.0240 | | 0.0346 |
| b2 | 1.23 | | 1.32 | 0.0484 | | 0.0520 |
| C | 4.40 | | 4.60 | 0.1732 | | 0.1811 |
| c1 | 0.49 | | 0.70 | 0.0193 | | 0.0276 |
| c2 | 2.40 | | 2.72 | 0.0945 | | 0.1071 |
| e | 2.40 | | 2.70 | 0.0945 | | 0.1063 |
| F | 6.20 | | 6.60 | 0.2441 | | 0.2598 |
| I | 3.73 | | 3.88 | 0.1469 | | 0.1528 |
| L | 2.65 | | 2.95 | 0.1043 | | 0.1161 |
| I2 | 1.14 | | 1.70 | 0.0449 | | 0.0669 |
| I3 | 1.14 | | 1.70 | 0.0449 | | 0.0669 |
| I4 | 15.80 | 16.40 | 16.80 | 0.6220 | 0.6457 | 0.6614 |
| M | | 2.6 | | | 0.1024 | |

Notes:

⁽¹⁾Inch dimensions are for reference only.

3 Ordering information

Figure 13: Ordering information scheme

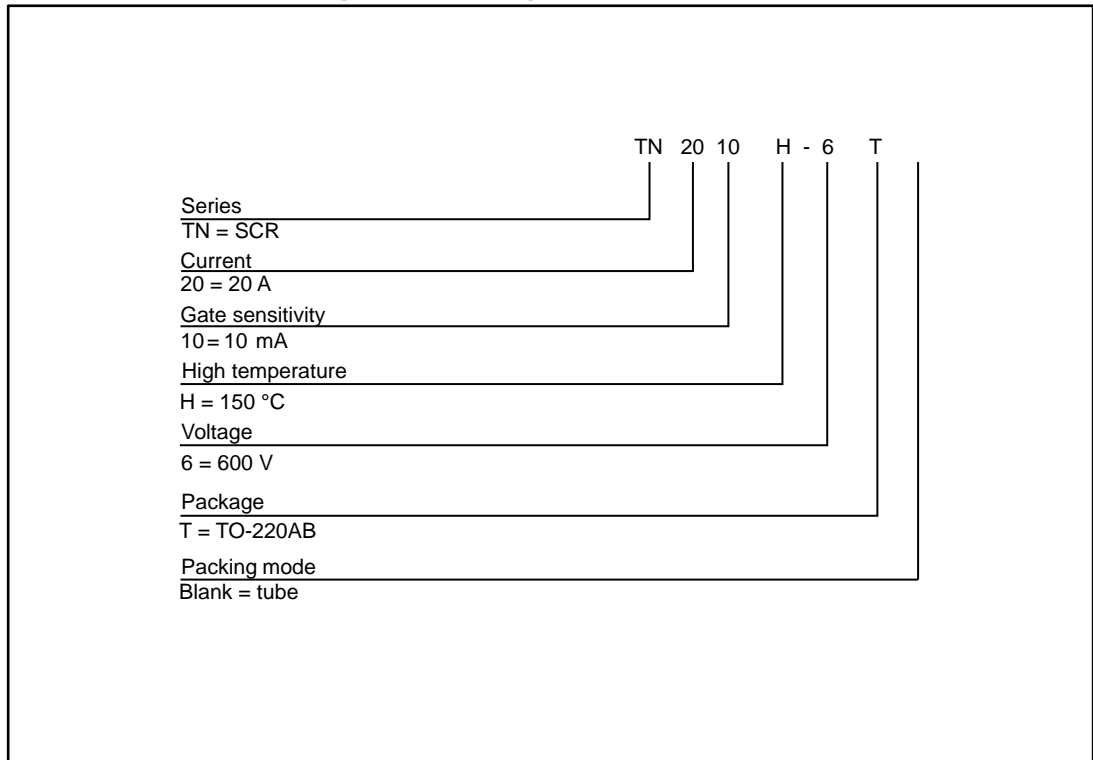

Table 7: Ordering information

| Order code | Marking | Package | Weight | Base qty. | Delivery mode |
|------------|----------|----------|--------|-----------|---------------|
| TN2010H-6T | TN2010H6 | TO-220AB | 2.3 g | 50 | Tube |

4 Revision history

Table 8: Document revision history

| Date | Revision | Changes |
|-------------|----------|------------------|
| 29-Aug-2017 | 1 | Initial release. |

IMPORTANT NOTICE – PLEASE READ CAREFULLY

STMicroelectronics NV and its subsidiaries ("ST") reserve the right to make changes, corrections, enhancements, modifications, and improvements to ST products and/or to this document at any time without notice. Purchasers should obtain the latest relevant information on ST products before placing orders. ST products are sold pursuant to ST's terms and conditions of sale in place at the time of order acknowledgement.

Purchasers are solely responsible for the choice, selection, and use of ST products and ST assumes no liability for application assistance or the design of Purchasers' products.

No license, express or implied, to any intellectual property right is granted by ST herein.

Resale of ST products with provisions different from the information set forth herein shall void any warranty granted by ST for such product.

ST and the ST logo are trademarks of ST. All other product or service names are the property of their respective owners.

Information in this document supersedes and replaces information previously supplied in any prior versions of this document.

© 2017 STMicroelectronics – All rights reserved

Компания «Life Electronics» занимается поставками электронных компонентов импортного и отечественного производства от производителей и со складов крупных дистрибьюторов Европы, Америки и Азии.

С конца 2013 года компания активно расширяет линейку поставок компонентов по направлению коаксиальный кабель, кварцевые генераторы и конденсаторы (керамические, пленочные, электролитические), за счёт заключения дистрибьюторских договоров

Мы предлагаем:

- Конкурентоспособные цены и скидки постоянным клиентам.
- Специальные условия для постоянных клиентов.
- Подбор аналогов.
- Поставку компонентов в любых объемах, удовлетворяющих вашим потребностям.
- Приемлемые сроки поставки, возможна ускоренная поставка.
- Доставку товара в любую точку России и стран СНГ.
- Комплексную поставку.
- Работу по проектам и поставку образцов.
- Формирование склада под заказчика.
- Сертификаты соответствия на поставляемую продукцию (по желанию клиента).
- Тестирование поставляемой продукции.
- Поставку компонентов, требующих военную и космическую приемку.
- Входной контроль качества.
- Наличие сертификата ISO.

В составе нашей компании организован Конструкторский отдел, призванный помогать разработчикам, и инженерам.

Конструкторский отдел помогает осуществить:

- Регистрацию проекта у производителя компонентов.
- Техническую поддержку проекта.
- Защиту от снятия компонента с производства.
- Оценку стоимости проекта по компонентам.
- Изготовление тестовой платы монтаж и пусконаладочные работы.



Тел: +7 (812) 336 43 04 (многоканальный)

Email: org@lifeelectronics.ru