



PCP1208

Bipolar Transistor 200V, 0.7A Low $V_{CE(sat)}$ NPN Single PCP

ON Semiconductor®

<http://onsemi.com>

Features

- $V_{CEO}=200V$, $I_C=0.7A$
- High allowable power dissipation
- Halogen free compliance
- Low collector-to-emitter saturation voltage $V_{CE(sat)}=0.115V$ (typ.)@ $I_C=0.35A$
- High-speed switching $t_f=70ns$ (typ.)@ $I_C=0.3A$

Specifications

Absolute Maximum Ratings at $T_a=25^\circ C$

Parameter	Symbol	Conditions	Ratings	Unit
Collector-to-Base Voltage	V_{CBO}		220	V
Collector-to-Emitter Voltage	V_{CEO}		200	V
Emitter-to-Base Voltage	V_{EBO}		8	V
Collector Current	I_C		0.7	A
Collector Current (Pulse)	I_{CP}		2	A
Base Current	I_B		140	mA
Collector Dissipation	PC	When mounted on ceramic substrate (450mm ² ×0.8mm)	1.3	W
		$T_c=25^\circ C$	3.5	W
Junction Temperature	T_j		150	$^\circ C$
Storage Temperature	T_{stg}		-55 to +150	$^\circ C$

Stresses exceeding Maximum Ratings may damage the device. Maximum Ratings are stress ratings only. Functional operation above the Recommended Operating Conditions is not implied. Extended exposure to stresses above the Recommended Operating Conditions may affect device reliability.

Package Dimensions

unit : mm (typ)

7008B-003

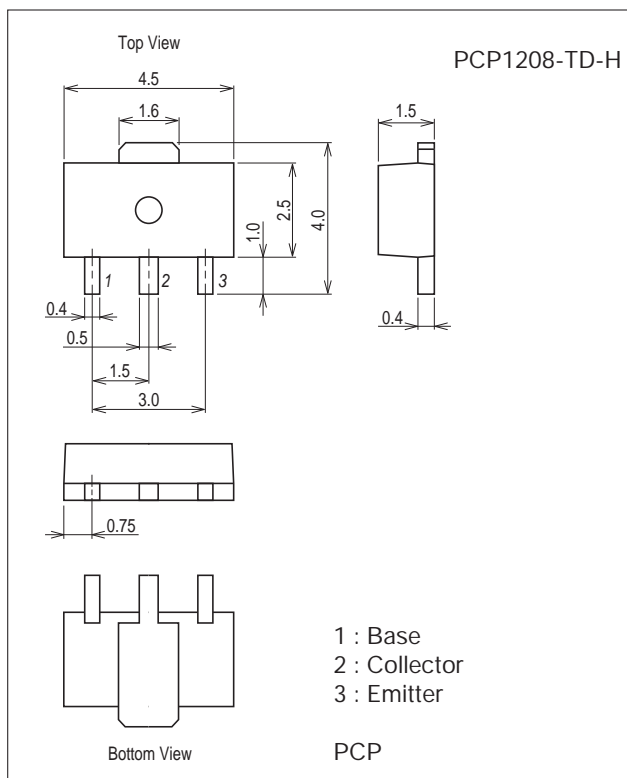

Ordering & Package Information

Device	Package	Shipping	note
PCP1208-TD-H	PCP (SC-62, SOT-89, TO-243)	1,000 pcs./reel	Pb Free and Halogen Free

Packing Type: TD

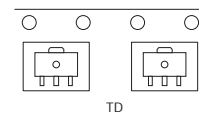

Marking

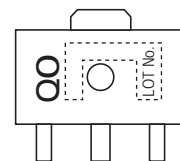

Electrical Connection

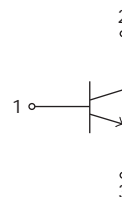

PCP1208

Electrical Characteristics at $T_a=25^\circ\text{C}$

Parameter	Symbol	Conditions	Ratings			Unit
			min	typ	max	
Collector Cutoff Current	I_{CBO}	$V_{CB}=100\text{V}, I_E=0\text{A}$			1	μA
Emitter Cutoff Current	I_{EBO}	$V_{EB}=4\text{V}, I_C=0\text{A}$			1	μA
DC Current Gain	h_{FE}	$V_{CE}=5\text{V}, I_C=100\text{mA}$	200		560	
Gain-Bandwidth Product	f_T	$V_{CE}=10\text{V}, I_C=100\text{mA}$		120		MHz
Output Capacitance	C_{ob}	$V_{CB}=10\text{V}, f=1\text{MHz}$		9		pF
Collector-to-Emitter Saturation Voltage	$V_{CE(sat)}$	$I_C=0.35\text{A}, I_B=35\text{mA}$		115	200	mV
Base-to-Emitter Saturation Voltage	$V_{BE(sat)}$	$I_C=0.35\text{A}, I_B=35\text{mA}$		0.82	1.2	V
Collector-to-Base Breakdown Voltage	$V_{(BR)CBO}$	$I_C=10\mu\text{A}, I_E=0\text{A}$	220			V
Collector-to-Emitter Breakdown Voltage	$V_{(BR)CEO}$	$I_C=1\text{mA}, R_{BE}=\infty$	200			V
Emitter-to-Base Breakdown Voltage	$V_{(BR)EBO}$	$I_E=10\mu\text{A}, I_C=0\text{A}$	8			V
Turn-On Time	t_{on}	See specified Test Circuit.		50		ns
Storage Time	t_{stg}			2		μs
Fall Time	t_f			70		ns

Switching Time Test Circuit

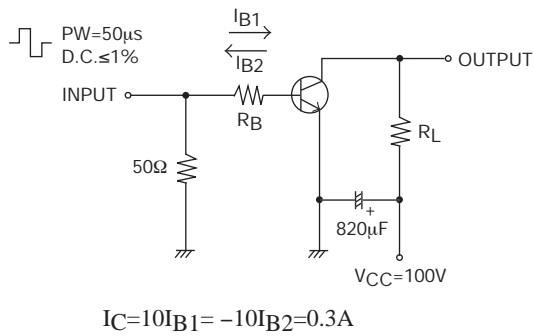

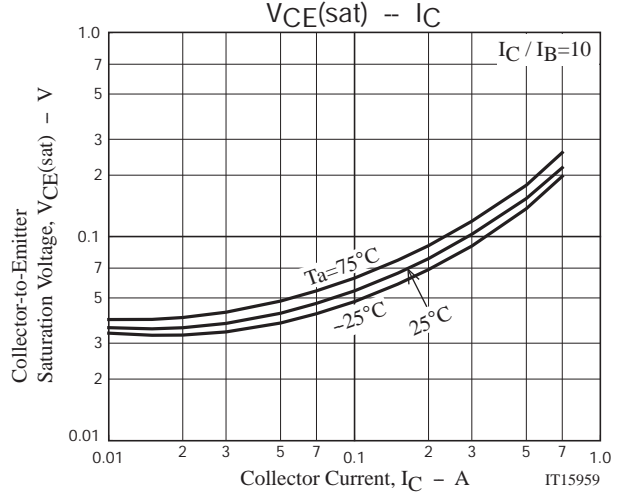
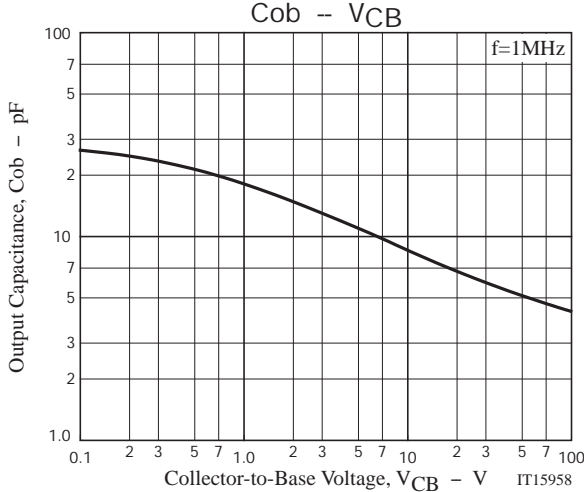
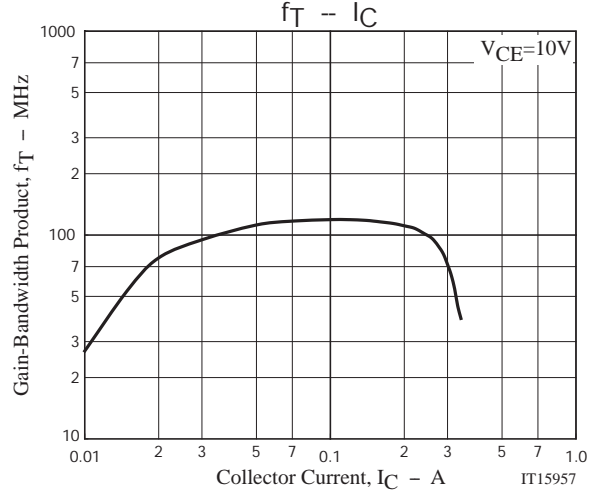
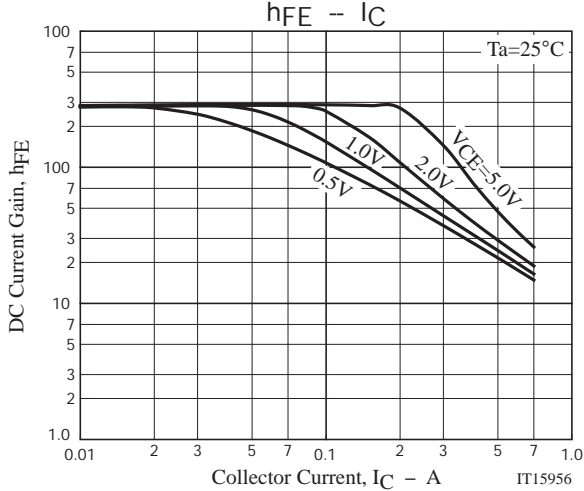
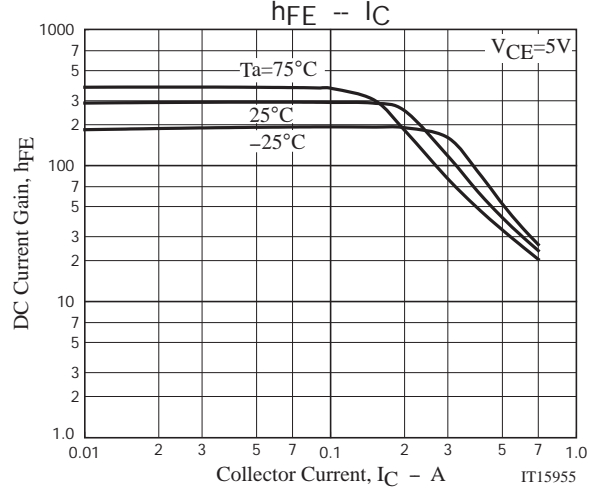
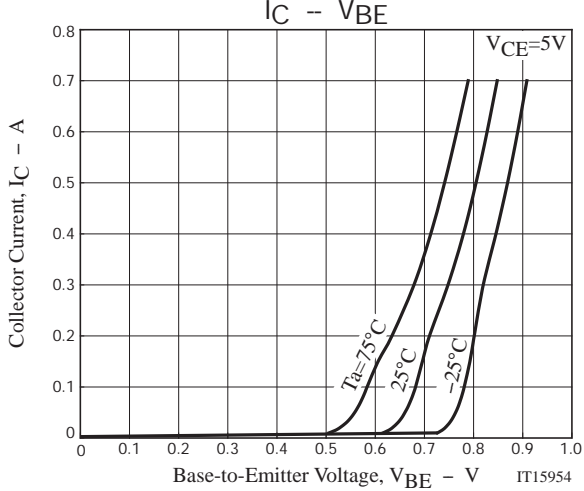
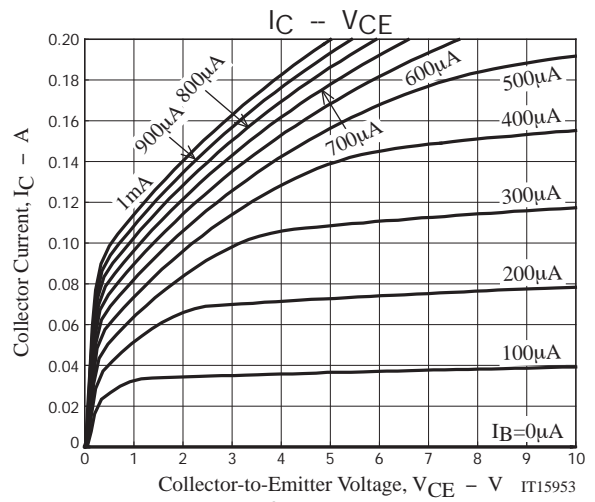
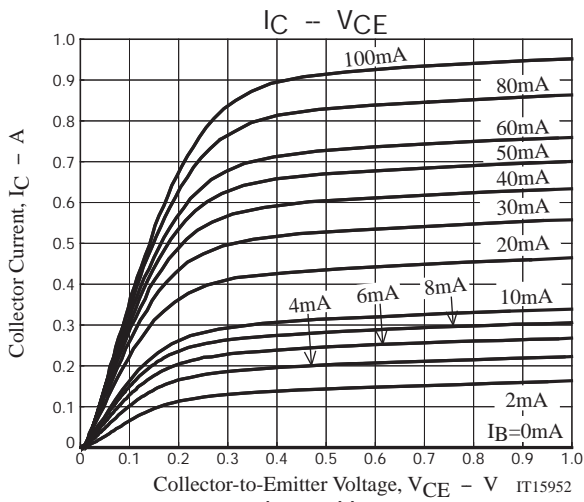

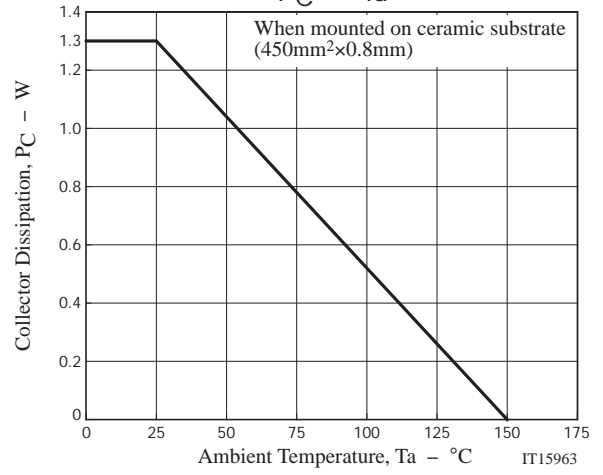
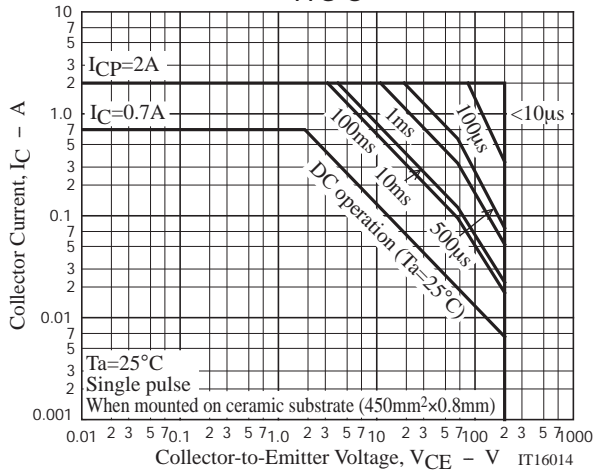
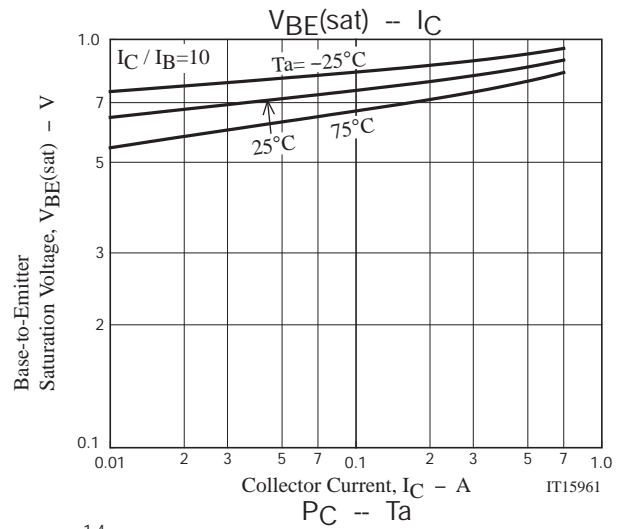
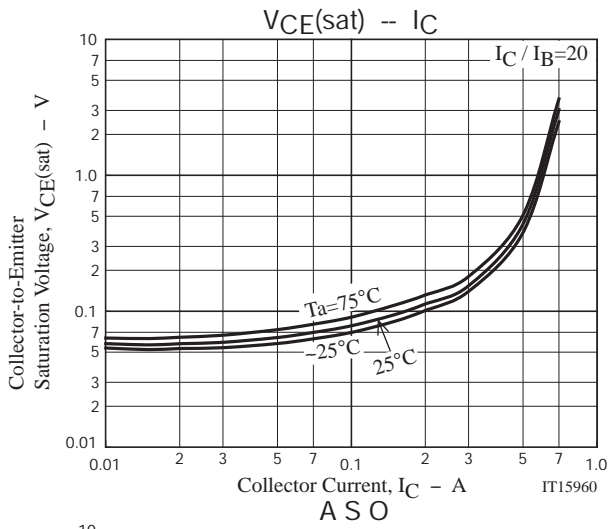

Bag Packing Specification

PCP1208-TD-H

1. Packing Format

Package Name	Carrier Tape Type	Maximum Number of devices contained (pcs)			Packing format	
		Reel	Inner box	Outer box	Inner BOX (C-1)	Outer BOX (A-7)
PCP	PCP	1,000	4,000	24,000	4 reels contained Dimensions:mm (external) 183×72×185	6 inner boxes contained Dimensions:mm (external) 440×195×210

Reel label, Inner box label
(unit : mm)

Outer box label
It is a label at the time of factory shipments.
The form of a label may change in physical distribution process.

Packing method

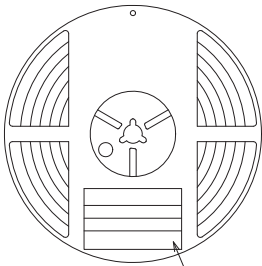

Reel label

Type No.
LOT No.
Quantity
Origin

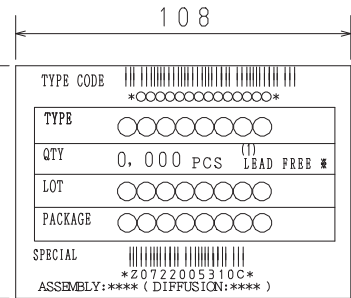
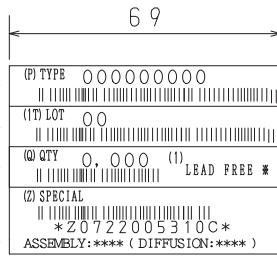

NOTE (1)

The LEAD FREE * description shows that the surface treatment of the terminal is lead free.

Label	JEITA Phase
LEAD FREE 3	JEITA Phase 3A
LEAD FREE 4	JEITA Phase 3

2. Taping configuration

2-1. Carrier tape size (unit:mm)

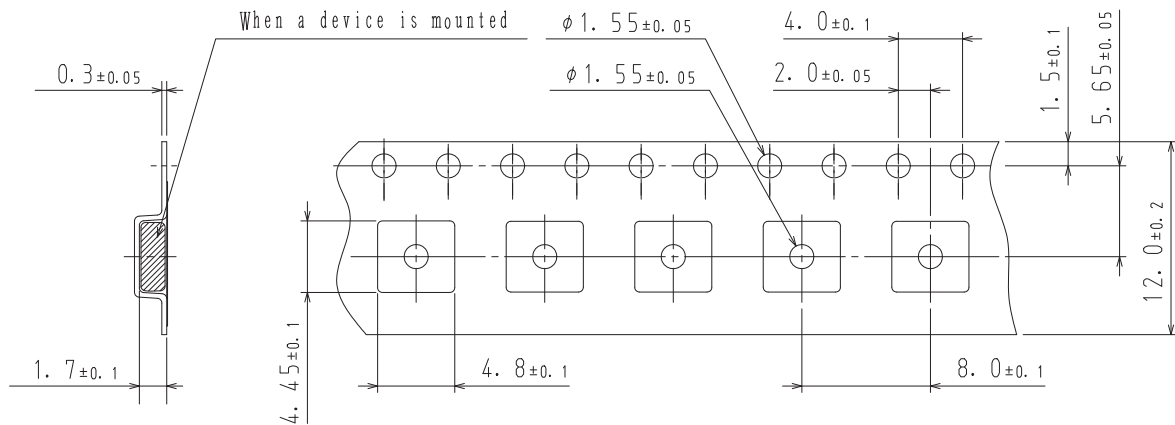

2-2. Device placement direction

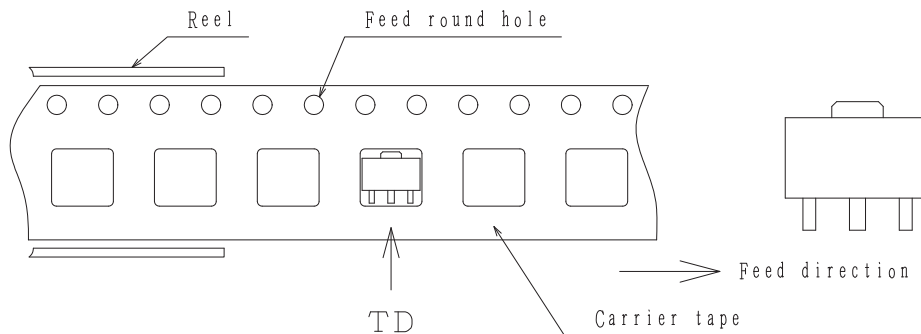

Those with pin 1 index on the feed hole side.....TD

PCP1208

Outline Drawing

PCP1208-TD-H

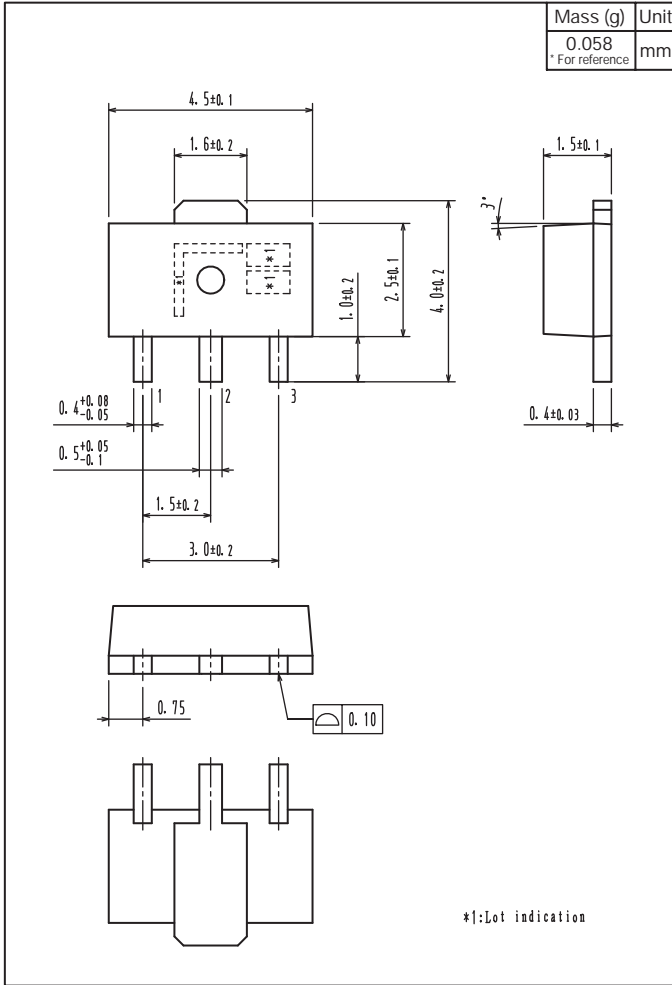

Land Pattern Example

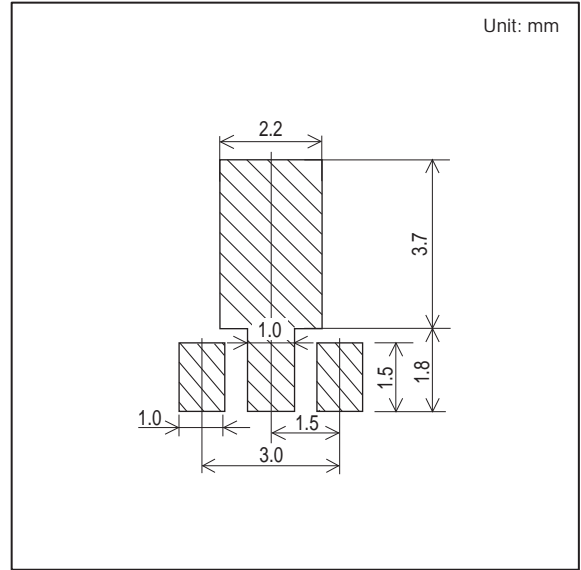

ON Semiconductor and the ON logo are registered trademarks of Semiconductor Components Industries, LLC (SCILLC). SCILLC owns the rights to a number of patents, trademarks, copyrights, trade secrets, and other intellectual property. A listing of SCILLC's product/patent coverage may be accessed at www.onsemi.com/site/pdf/Patent-Marking.pdf. SCILLC reserves the right to make changes without further notice to any products herein. SCILLC makes no warranty, representation or guarantee regarding the suitability of its products for any particular purpose, nor does SCILLC assume any liability arising out of the application or use of any product or circuit, and specifically disclaims any and all liability, including without limitation special, consequential or incidental damages. "Typical" parameters which may be provided in SCILLC data sheets and/or specifications can and do vary in different applications and actual performance may vary over time. All operating parameters, including "Typicals" must be validated for each customer application by customer's technical experts. SCILLC does not convey any license under its patent rights nor the rights of others. SCILLC products are not designed, intended, or authorized for use as components in systems intended for surgical implant into the body, or other applications intended to support or sustain life, or for any other application in which the failure of the SCILLC product could create a situation where personal injury or death may occur. Should Buyer purchase or use SCILLC products for any such unintended or unauthorized application, Buyer shall indemnify and hold SCILLC and its officers, employees, subsidiaries, affiliates, and distributors harmless against all claims, costs, damages, and expenses, and reasonable attorney fees arising out of, directly or indirectly, any claim of personal injury or death associated with such unintended or unauthorized use, even if such claim alleges that SCILLC was negligent regarding the design or manufacture of the part. SCILLC is an Equal Opportunity/Affirmative Action Employer. This literature is subject to all applicable copyright laws and is not for resale in any manner.

Mouser Electronics

Authorized Distributor

Click to View Pricing, Inventory, Delivery & Lifecycle Information:

[ON Semiconductor:](#)

[PCP1208-TD-H](#)

Компания «Life Electronics» занимается поставками электронных компонентов импортного и отечественного производства от производителей и со складов крупных дистрибьюторов Европы, Америки и Азии.

С конца 2013 года компания активно расширяет линейку поставок компонентов по направлению коаксиальный кабель, кварцевые генераторы и конденсаторы (керамические, пленочные, электролитические), за счёт заключения дистрибьюторских договоров

Мы предлагаем:

- Конкурентоспособные цены и скидки постоянным клиентам.
- Специальные условия для постоянных клиентов.
- Подбор аналогов.
- Поставку компонентов в любых объемах, удовлетворяющих вашим потребностям.
- Приемлемые сроки поставки, возможна ускоренная поставка.
- Доставку товара в любую точку России и стран СНГ.
- Комплексную поставку.
- Работу по проектам и поставку образцов.
- Формирование склада под заказчика.
- Сертификаты соответствия на поставляемую продукцию (по желанию клиента).
- Тестирование поставляемой продукции.
- Поставку компонентов, требующих военную и космическую приемку.
- Входной контроль качества.
- Наличие сертификата ISO.

В составе нашей компании организован Конструкторский отдел, призванный помогать разработчикам, и инженерам.

Конструкторский отдел помогает осуществить:

- Регистрацию проекта у производителя компонентов.
- Техническую поддержку проекта.
- Защиту от снятия компонента с производства.
- Оценку стоимости проекта по компонентам.
- Изготовление тестовой платы монтаж и пусконаладочные работы.



Тел: +7 (812) 336 43 04 (многоканальный)

Email: org@lifeelectronics.ru