

# MC74VHCT04A

## Hex Inverter

The MC74VHCT04A is an advanced high speed CMOS inverter fabricated with silicon gate CMOS technology. It achieves high speed operation similar to equivalent Bipolar Schottky TTL while maintaining CMOS low power dissipation.

The internal circuit is composed of three stages, including a buffer output which provides high noise immunity and stable output. The inputs tolerate voltages up to 7 V, allowing the interface of 5 V systems to 3 V systems.

The VHCT inputs are compatible with TTL levels. This device can be used as a level converter for interfacing 3.3 V to 5.0 V, because it has full 5 V CMOS level output swings.

The VHCT04A input structures provide protection when voltages between 0 V and 5.5 V are applied, regardless of the supply voltage. The output structures also provide protection when  $V_{CC} = 0$  V. These input and output structures help prevent device destruction caused by supply voltage – input/output voltage mismatch, battery backup, hot insertion, etc.

### Features

- High Speed:  $t_{PD} = 4.7$  ns (Typ) at  $V_{CC} = 5$  V
- Low Power Dissipation:  $I_{CC} = 2$   $\mu$ A (Max) at  $T_A = 25^\circ$ C
- TTL-Compatible Inputs:  $V_{IL} = 0.8$  V;  $V_{IH} = 2.0$  V
- Power Down Protection Provided on Inputs and Outputs
- Balanced Propagation Delays
- Designed for 4.5 V to 5.5 V Operating Range
- Low Noise:  $V_{OLP} = 1.0$  V (Max)
- Pin and Function Compatible with Other Standard Logic Families
- Latchup Performance Exceeds 300 mA
- ESD Performance: HBM > 2000 V; Machine Model > 200 V
- Chip Complexity: 48 FETs or 12 Equivalent Gates
- These Devices are Pb-Free and are RoHS Compliant



ON Semiconductor®

<http://onsemi.com>

### MARKING DIAGRAMS

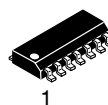

SOIC-14  
D SUFFIX  
CASE 751A

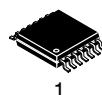
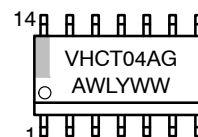

TSSOP-14  
DT SUFFIX  
CASE 948G

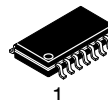
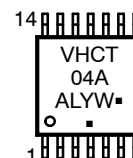

SOEIAJ-14  
M SUFFIX  
CASE 965

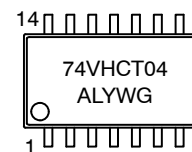

A = Assembly Location  
WL, L = Wafer Lot  
Y = Year  
WW, W = Work Week  
G or ■ = Pb-Free Package

(Note: Microdot may be in either location)

### ORDERING INFORMATION

Device	Package	Shipping†
MC74VHCT04ADR2G	SOIC-14 (Pb-Free)	2500/Tape&Reel
MC74VHCT04ADTR2G	TSSOP14 (Pb-Free)	2500/Tape&Reel
MC74VHCT04AMELG	SOEIAJ14 (Pb-Free)	2000/Tape&Reel

†For information on tape and reel specifications, including part orientation and tape sizes, please refer to our Tape and Reel Packaging Specifications Brochure, BRD8011/D.

# MC74VHCT04A

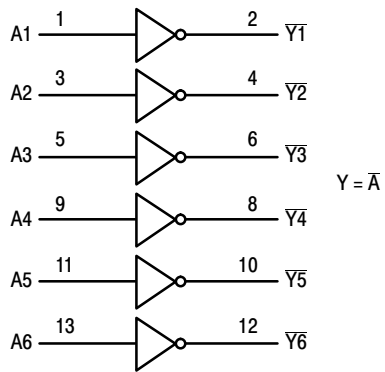

Figure 1. Logic Diagram

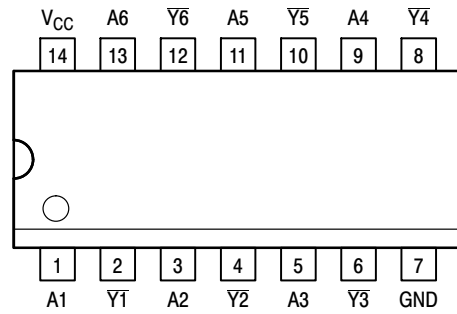

Figure 2. Pinout: 14-Lead Packages (Top View)

## FUNCTION TABLE

Inputs	Outputs
A	$\bar{Y}$
L	H
H	L

# MC74VHCT04A

## MAXIMUM RATINGS\*

Symbol	Parameter	Value	Unit
$V_{CC}$	DC Supply Voltage	- 0.5 to + 7.0	V
$V_{in}$	DC Input Voltage	- 0.5 to + 7.0	V
$V_{out}$	DC Output Voltage $V_{CC} = 0$ High or Low State	- 0.5 to + 7.0 - 0.5 to $V_{CC} + 0.5$	V
$I_{IK}$	Input Diode Current	- 20	mA
$I_{OK}$	Output Diode Current ( $V_{OUT} < GND$ ; $V_{OUT} > V_{CC}$ )	$\pm 20$	mA
$I_{out}$	DC Output Current, per Pin	$\pm 25$	mA
$I_{CC}$	DC Supply Current, $V_{CC}$ and GND Pins	$\pm 50$	mA
$P_D$	Power Dissipation in Still Air, SOIC Packages† TSSOP Package†	500 450	mW
$T_{stg}$	Storage Temperature	- 65 to + 150	°C

This device contains protection circuitry to guard against damage due to high static voltages or electric fields. However, precautions must be taken to avoid applications of any voltage higher than maximum rated voltages to this high-impedance circuit. For proper operation,  $V_{in}$  and  $V_{out}$  should be constrained to the range  $GND \leq (V_{in} \text{ or } V_{out}) \leq V_{CC}$ . Unused inputs must always be tied to an appropriate logic voltage level (e.g., either GND or  $V_{CC}$ ). Unused outputs must be left open.

\* Absolute maximum continuous ratings are those values beyond which damage to the device may occur. Exposure to these conditions or conditions beyond those indicated may adversely affect device reliability. Functional operation under absolute-maximum-rated conditions is not implied.

† Derating — SOIC Packages: - 7 mW/°C from 65° to 125°C  
TSSOP Package: - 6.1 mW/°C from 65° to 125°C

## RECOMMENDED OPERATING CONDITIONS

Symbol	Parameter	Min	Max	Unit
$V_{CC}$	DC Supply Voltage	4.5	5.5	V
$V_{in}$	DC Input Voltage	0	5.5	V
$V_{out}$	DC Output Voltage $V_{CC} = 0$ High or Low State	0 0	5.5 $V_{CC}$	V
$T_A$	Operating Temperature	- 40	+ 85	°C
$t_r, t_f$	Input Rise and Fall Time $V_{CC} = 5.0V \pm 0.5V$	0	20	ns/V

## DC ELECTRICAL CHARACTERISTICS

Symbol	Parameter	Test Conditions	$V_{CC}$ V	$T_A = 25^\circ\text{C}$			$T_A = - 40 \text{ to } 85^\circ\text{C}$		Unit
				Min	Typ	Max	Min	Max	
$V_{IH}$	Minimum High-Level Input Voltage		4.5 to 5.5	2.0			2.0		V
$V_{IL}$	Maximum Low-Level Input Voltage		4.5 to 5.5			0.8		0.8	V
$V_{OH}$	Minimum High-Level Output Voltage $V_{in} = V_{IH}$ or $V_{IL}$	$I_{OH} = - 50\mu\text{A}$	4.5	4.4	4.5		4.4		V
		$I_{OH} = - 8\text{mA}$	4.5	3.94			3.80		
$V_{OL}$	Maximum Low-Level Output Voltage $V_{in} = V_{IH}$ or $V_{IL}$	$I_{OL} = 50\mu\text{A}$	4.5		0.0	0.1		0.1	V
		$I_{OL} = 8\text{mA}$	4.5			0.36		0.44	
$I_{in}$	Maximum Input Leakage Current	$V_{in} = 5.5\text{V}$ or GND	0 to 5.5			$\pm 0.1$		$\pm 1.0$	$\mu\text{A}$
$I_{CC}$	Maximum Quiescent Supply Current	$V_{in} = V_{CC}$ or GND	5.5			2.0		20.0	$\mu\text{A}$
$I_{CCT}$	Quiescent Supply Current	Per Input: $V_{IN} = 3.4\text{V}$ Other Input: $V_{CC}$ or GND	5.5			1.35		1.50	mA
$I_{OPD}$	Output Leakage Current	$V_{OUT} = 5.5\text{V}$	0			0.5		5.0	$\mu\text{A}$

# MC74VHCT04A

## AC ELECTRICAL CHARACTERISTICS (Input $t_r = t_f = 3.0\text{ns}$ )

Symbol	Parameter	Test Conditions	$T_A = 25^\circ\text{C}$			$T_A = -40 \text{ to } 85^\circ\text{C}$		Unit
			Min	Typ	Max	Min	Max	
$t_{PLH}$ , $t_{PHL}$	Maximum Propagation Delay, A to Y	$V_{CC} = 5.0 \pm 0.5\text{V}$ $C_L = 15\text{pF}$ $C_L = 50\text{pF}$		4.7 5.5	6.7 7.7	1.0 1.0	7.5 8.5	ns
$C_{in}$	Maximum Input Capacitance			4	10		10	pF

$C_{PD}$	Power Dissipation Capacitance (Note 1)	Typical @ $25^\circ\text{C}$ , $V_{CC} = 5.0\text{V}$		pF
		11		

1.  $C_{PD}$  is defined as the value of the internal equivalent capacitance which is calculated from the operating current consumption without load. Average operating current can be obtained by the equation:  $I_{CC(OPR)} = C_{PD} \cdot V_{CC} \cdot f_{in} + I_{CC}/6$  (per buffer).  $C_{PD}$  is used to determine the no-load dynamic power consumption;  $P_D = C_{PD} \cdot V_{CC}^2 \cdot f_{in} + I_{CC} \cdot V_{CC}$ .

## NOISE CHARACTERISTICS (Input $t_r = t_f = 3.0\text{ns}$ , $C_L = 50\text{pF}$ , $V_{CC} = 5.0\text{V}$ )

Symbol	Characteristic	$T_A = 25^\circ\text{C}$		Unit
		Typ	Max	
$V_{OLP}$	Quiet Output Maximum Dynamic $V_{OL}$	0.8	1.0	V
$V_{OLV}$	Quiet Output Minimum Dynamic $V_{OL}$	-0.8	-1.0	V
$V_{IHD}$	Minimum High Level Dynamic Input Voltage		2.0	V
$V_{ILD}$	Maximum Low Level Dynamic Input Voltage		0.8	V

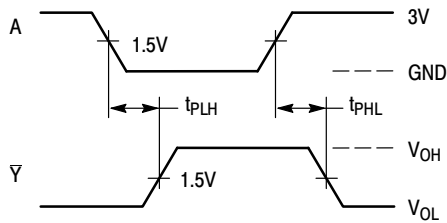
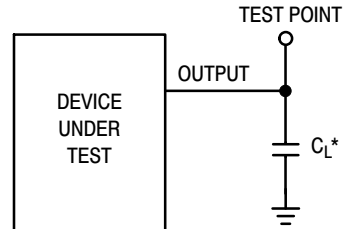

Figure 3. Switching Waveforms



\*Includes all probe and jig capacitance

Figure 4. Test Circuit

# MC74VHCT04A

## PACKAGE DIMENSIONS

SOIC-14  
CASE 751A-03  
ISSUE J

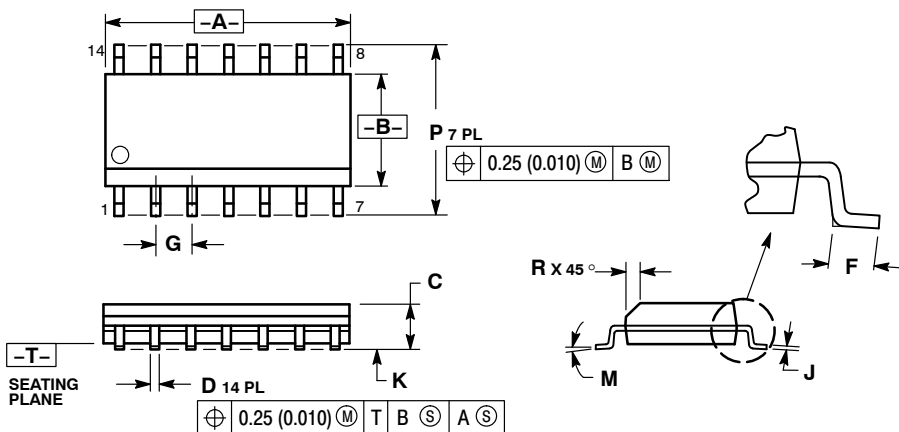

- NOTES:
1. DIMENSIONING AND TOLERANCING PER ANSI Y14.5M, 1982.
  2. CONTROLLING DIMENSION: MILLIMETER.
  3. DIMENSIONS A AND B DO NOT INCLUDE MOLD PROTRUSION.
  4. MAXIMUM MOLD PROTRUSION 0.15 (0.006) PER SIDE.
  5. DIMENSION D DOES NOT INCLUDE DAMBAR PROTRUSION. ALLOWABLE DAMBAR PROTRUSION SHALL BE 0.127 (0.005) TOTAL IN EXCESS OF THE D DIMENSION AT MAXIMUM MATERIAL CONDITION.

DIM	MILLIMETERS		INCHES	
	MIN	MAX	MIN	MAX
A	8.55	8.75	0.337	0.344
B	3.80	4.00	0.150	0.157
C	1.35	1.75	0.054	0.068
D	0.35	0.49	0.014	0.019
F	0.40	1.25	0.016	0.049
G	1.27 BSC		0.050 BSC	
J	0.19	0.25	0.008	0.009
K	0.10	0.25	0.004	0.009
M	0°	7°	0°	7°
P	5.80	6.20	0.228	0.244
R	0.25	0.50	0.010	0.019

### SOLDERING FOOTPRINT\*

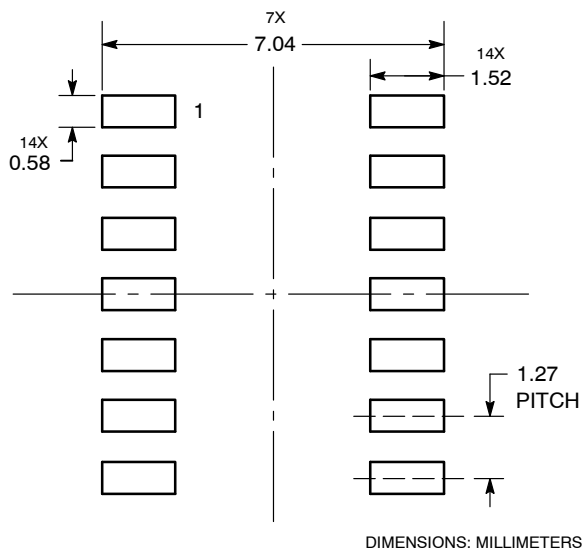

\*For additional information on our Pb-Free strategy and soldering details, please download the ON Semiconductor Soldering and Mounting Techniques Reference Manual, SOLDERRM/D.

# MC74VHCT04A

## PACKAGE DIMENSIONS

TSSOP-14  
DT SUFFIX  
CASE 948G-01  
ISSUE B

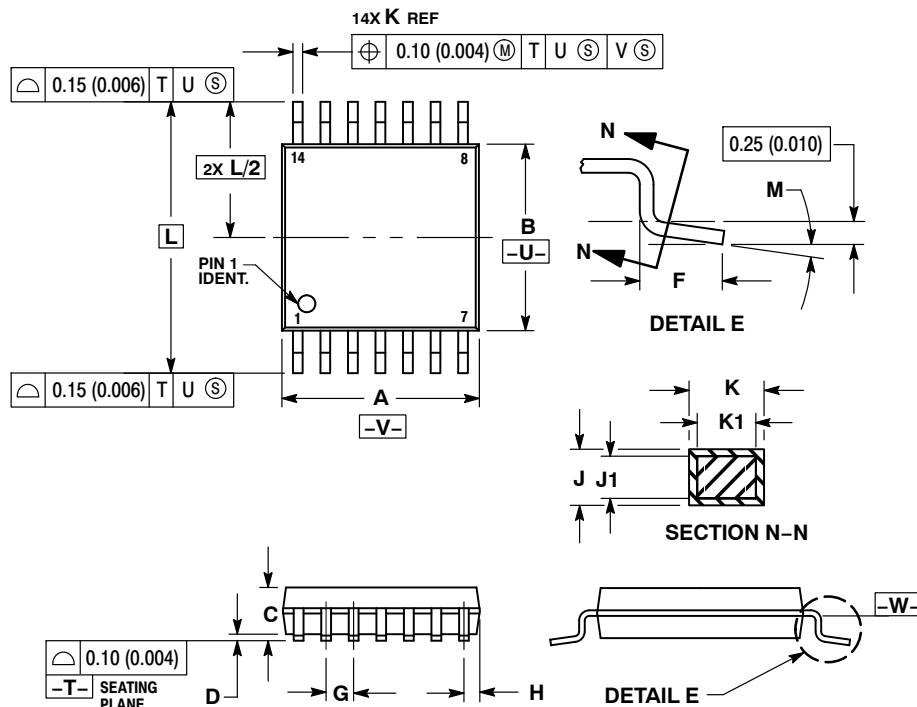

- NOTES:
1. DIMENSIONING AND TOLERANCING PER ANSI Y14.5M, 1982.
  2. CONTROLLING DIMENSION: MILLIMETER.
  3. DIMENSION A DOES NOT INCLUDE MOLD FLASH, PROTRUSIONS OR GATE BURRS. MOLD FLASH OR GATE BURRS SHALL NOT EXCEED 0.15 (0.006) PER SIDE.
  4. DIMENSION B DOES NOT INCLUDE INTERLEAD FLASH OR PROTRUSION. INTERLEAD FLASH OR PROTRUSION SHALL NOT EXCEED 0.25 (0.010) PER SIDE.
  5. DIMENSION K DOES NOT INCLUDE DAMBAR PROTRUSION. ALLOWABLE DAMBAR PROTRUSION SHALL BE 0.08 (0.003) TOTAL IN EXCESS OF THE K DIMENSION AT MAXIMUM MATERIAL CONDITION.
  6. TERMINAL NUMBERS ARE SHOWN FOR REFERENCE ONLY.
  7. DIMENSION A AND B ARE TO BE DETERMINED AT DATUM PLANE -W-.

DIM	MILLIMETERS		INCHES	
	MIN	MAX	MIN	MAX
A	4.90	5.10	0.193	0.200
B	4.30	4.50	0.169	0.177
C	---	1.20	---	0.047
D	0.05	0.15	0.002	0.006
F	0.50	0.75	0.020	0.030
G	0.65 BSC		0.026 BSC	
H	0.50	0.60	0.020	0.024
J	0.09	0.20	0.004	0.008
J1	0.09	0.16	0.004	0.006
K	0.19	0.30	0.007	0.012
K1	0.19	0.25	0.007	0.010
L	6.40 BSC		0.252 BSC	
M	0°	8°	0°	8°

### SOLDERING FOOTPRINT\*

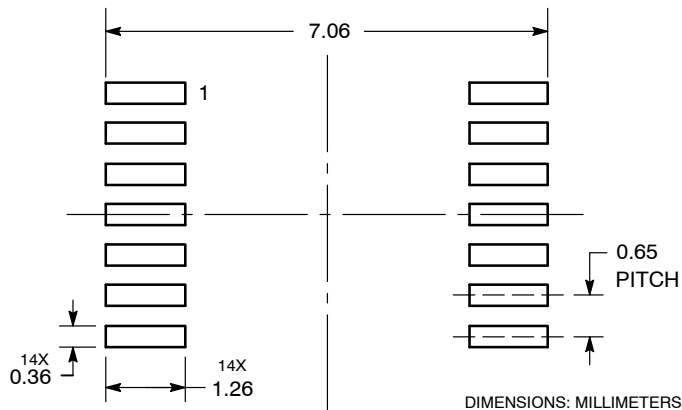

\*For additional information on our Pb-Free strategy and soldering details, please download the ON Semiconductor Soldering and Mounting Techniques Reference Manual, SOLDERRM/D.

# MC74VHCT04A

## PACKAGE DIMENSIONS

SOEIAJ-14  
CASE 965-01  
ISSUE B

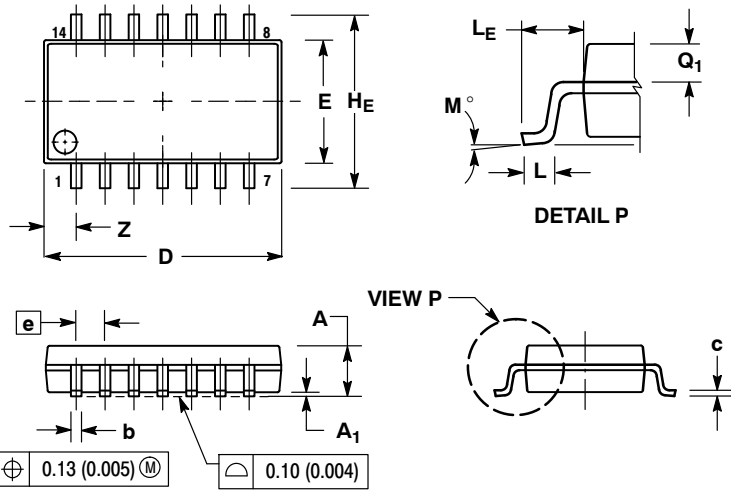

### NOTES:

1. DIMENSIONING AND TOLERANCING PER ANSI Y14.5M, 1982.
2. CONTROLLING DIMENSION: MILLIMETER.
3. DIMENSIONS D AND E DO NOT INCLUDE MOLD FLASH OR PROTRUSIONS AND ARE MEASURED AT THE PARTING LINE. MOLD FLASH OR PROTRUSIONS SHALL NOT EXCEED 0.15 (0.006) PER SIDE.
4. TERMINAL NUMBERS ARE SHOWN FOR REFERENCE ONLY.
5. THE LEAD WIDTH DIMENSION (b) DOES NOT INCLUDE DAMBAR PROTRUSION. ALLOWABLE DAMBAR PROTRUSION SHALL BE 0.08 (0.003) TOTAL IN EXCESS OF THE LEAD WIDTH DIMENSION AT MAXIMUM MATERIAL CONDITION. DAMBAR CANNOT BE LOCATED ON THE LOWER RADIUS OR THE FOOT. MINIMUM SPACE BETWEEN PROTRUSIONS AND ADJACENT LEAD TO BE 0.46 (0.018).

DIM	MILLIMETERS		INCHES	
	MIN	MAX	MIN	MAX
A	---	2.05	---	0.081
A <sub>1</sub>	0.05	0.20	0.002	0.008
b	0.35	0.50	0.014	0.020
c	0.10	0.20	0.004	0.008
D	9.90	10.50	0.390	0.413
E	5.10	5.45	0.201	0.215
e	1.27 BSC		0.050 BSC	
H <sub>E</sub>	7.40	8.20	0.291	0.323
L	0.50	0.85	0.020	0.033
L <sub>E</sub>	1.10	1.50	0.043	0.059
M	0°	10°	0°	10°
Q <sub>1</sub>	0.70	0.90	0.028	0.035
Z	---	1.42	---	0.056

ON Semiconductor and are registered trademarks of Semiconductor Components Industries, LLC (SCILLC). SCILLC reserves the right to make changes without further notice to any products herein. SCILLC makes no warranty, representation or guarantee regarding the suitability of its products for any particular purpose, nor does SCILLC assume any liability arising out of the application or use of any product or circuit, and specifically disclaims any and all liability, including without limitation special, consequential or incidental damages. "Typical" parameters which may be provided in SCILLC data sheets and/or specifications can and do vary in different applications and actual performance may vary over time. All operating parameters, including "Typicals" must be validated for each customer application by customer's technical experts. SCILLC does not convey any license under its patent rights nor the rights of others. SCILLC products are not designed, intended, or authorized for use as components in systems intended for surgical implant into the body, or other applications intended to support or sustain life, or for any other application in which the failure of the SCILLC product could create a situation where personal injury or death may occur. Should Buyer purchase or use SCILLC products for any such unintended or unauthorized application, Buyer shall indemnify and hold SCILLC and its officers, employees, subsidiaries, affiliates, and distributors harmless against all claims, costs, damages, and expenses, and reasonable attorney fees arising out of, directly or indirectly, any claim of personal injury or death associated with such unintended or unauthorized use, even if such claim alleges that SCILLC was negligent regarding the design or manufacture of the part. SCILLC is an Equal Opportunity/Affirmative Action Employer. This literature is subject to all applicable copyright laws and is not for resale in any manner.

### PUBLICATION ORDERING INFORMATION

**LITERATURE FULFILLMENT:**  
Literature Distribution Center for ON Semiconductor  
P.O. Box 5163, Denver, Colorado 80217 USA  
**Phone:** 303-675-2175 or 800-344-3860 Toll Free USA/Canada  
**Fax:** 303-675-2176 or 800-344-3867 Toll Free USA/Canada  
**Email:** orderlit@onsemi.com

**N. American Technical Support:** 800-282-9855 Toll Free  
USA/Canada  
**Europe, Middle East and Africa Technical Support:**  
Phone: 421 33 790 2910  
**Japan Customer Focus Center**  
Phone: 81-3-5773-3850

**ON Semiconductor Website:** [www.onsemi.com](http://www.onsemi.com)  
**Order Literature:** <http://www.onsemi.com/orderlit>

For additional information, please contact your local Sales Representative

Компания «Life Electronics» занимается поставками электронных компонентов импортного и отечественного производства от производителей и со складов крупных дистрибьюторов Европы, Америки и Азии.

С конца 2013 года компания активно расширяет линейку поставок компонентов по направлению коаксиальный кабель, кварцевые генераторы и конденсаторы (керамические, пленочные, электролитические), за счёт заключения дистрибьюторских договоров

Мы предлагаем:

- Конкурентоспособные цены и скидки постоянным клиентам.
- Специальные условия для постоянных клиентов.
- Подбор аналогов.
- Поставку компонентов в любых объемах, удовлетворяющих вашим потребностям.
- Приемлемые сроки поставки, возможна ускоренная поставка.
- Доставку товара в любую точку России и стран СНГ.
- Комплексную поставку.
- Работу по проектам и поставку образцов.
- Формирование склада под заказчика.
- Сертификаты соответствия на поставляемую продукцию (по желанию клиента).
- Тестирование поставляемой продукции.
- Поставку компонентов, требующих военную и космическую приемку.
- Входной контроль качества.
- Наличие сертификата ISO.

В составе нашей компании организован Конструкторский отдел, призванный помогать разработчикам, и инженерам.

Конструкторский отдел помогает осуществить:

- Регистрацию проекта у производителя компонентов.
- Техническую поддержку проекта.
- Защиту от снятия компонента с производства.
- Оценку стоимости проекта по компонентам.
- Изготовление тестовой платы монтаж и пусконаладочные работы.



Тел: +7 (812) 336 43 04 (многоканальный)

Email: [org@lifeelectronics.ru](mailto:org@lifeelectronics.ru)