

One Cell Li-ion/Li-polymer Linear Charger IC with Battery Temperature Detection

■ GENERAL DESCRIPTION

The XC6804 is a Constant-Voltage (CV) and Constant-Current (CC) type charging IC for linear charging of single-cell Li-ion batteries and Li-polymer batteries. The basic charging cycle consists of trickle charge mode followed by main charge mode. This IC supports temperature control based on JEITA, making it possible to safely charge Li-ion batteries and Li-polymer batteries by controlling the CV charge voltage and CC charge current according to the temperature. By connecting a resistor to the charge status output pin, it is possible to check the charge condition via the charge status output (CSO) pin voltage. The IC is housed in the small SOP-8FD or USP-6EL package with high heat dissipation, and a charge circuit can be configured using a minimum of external components.

■ APPLICATIONS

- Health care devices
- Power banks
- Portable audio players
- Bluetooth headsets
- Portable navigation devices
- Digital still cameras

■ FEATURES

JEITA conforming Thermistor Detect Function Built-in	
Operating Voltage Range	: 4.5V ~ 6V
Supply Current	: TYP. 100 μ A
CC Charge Current	: 200mA ~ 800mA Can be set by external resistance
CV Charge Voltage	: 4.2V, 4.05V (at high temperature) Internally fixed
Protection Circuit	: Thermistor detection function Safety timer function UVLO (Under Voltage Lockout) Thermal shutdown (Auto recovery) Dropout voltage monitor function Charging over-voltage monitor function Charging over-current monitor function Recharge function (XC6804xxE)
Operating Ambient Temperature	: -40°C ~ +85°C
Packages	: SOP-8FD, USP-6EL
Environmentally Friendly	: EU RoHS Compliant, Pb Free

■ TYPICAL APPLICATION CIRCUIT

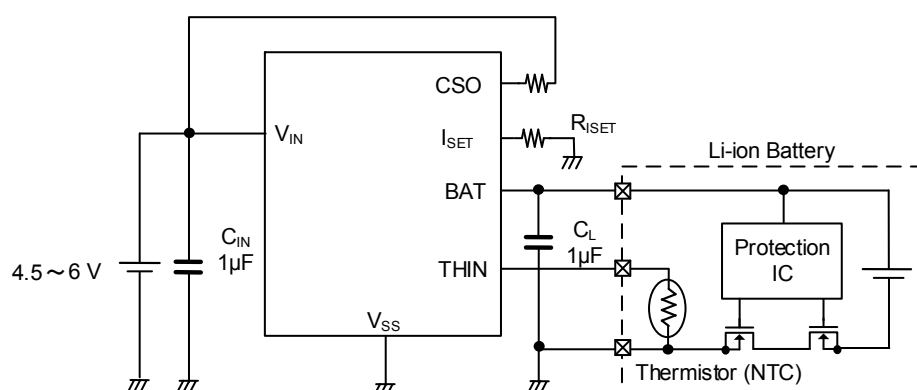

XC6804 Series

■ BLOCK DIAGRAM



■ PRODUCT CLASSIFICATION

XC6804①②③④⑤⑥-⑦ (*1)

DESIGNATOR	DESCRIPTION	SYMBOL	DESCRIPTION
①	Charge Status Output on Abnormal Mode	A	1 kHz ON-OFF
		B	OFF
②	Battery Temperature Monitor Function	2	2 Temperature Monitor
		3	3 Temperature Monitor
		4	4 Temperature Monitor
③	Recharge Function	E	Enable
		D	Disable
④	CV Charge Voltage	1	4.2 V (Fixed)
⑤⑥-⑦	Packages (Order Unit)	QR-G	SOP-8FD (1,000pcs/Reel)
		4R-G	USP-6EL (3,000pcs/Reel)

(*1) The "-G" suffix denotes Halogen and Antimony free as well as being fully EU RoHS compliant.

■ PIN CONFIGURATION



SOP-8FD
(TOP VIEW)



USP-6EL
(BOTTOM VIEW)

*To increase mounting strength and heat dissipation of the USP-6EL, it is recommended that the heat sink be mounted by soldering using the reference pattern layout and reference metal mask. To use the electric potential of the heat sink, connect to the V_{SS} pin (Pin # 2).

*To increase mounting strength and heat dissipation of the SOP-8FD, it is recommended that the heat sink be mounted by soldering using the reference pattern layout and reference metal mask. To use the electric potential of the heat sink, connect to the V_{SS} pin (Pin # 3).

■ PIN ASSIGNMENT

PIN NUMBER		PIN NAME	FUNCTIONS
SOP-8FD	USP-6EL		
1	1	BAT	Charge Current Output
3	2	V_{SS}	Ground
4	3	CSO	Charge Status Output
5	4	I_{SET}	Charge Current Setup
6	5	THIN	Temperature Detection
8	6	V_{IN}	Power Supply Input
-	Back Metal	-	Internally Connected V_{SS}
2, 7	-	NC	Non connect Pin

ABSOLUTE MAXIMUM RATINGS

Ta = 25°C

PARAMETER		SYMBOL	RATING	UNIT
V _{IN} Pin Voltage		V _{IN}	-0.3 ~ +6.5	V
BAT Pin Voltage		V _{BAT}	-0.3 ~ +6.5	V
CSO Pin Voltage		V _{CSO}	-0.3 ~ +6.5	V
THIN Pin Voltage		V _{THIN}	-0.3 ~ V _{IN} +0.3 or +6.5 ^(*)	V
I _{SET} Pin Voltage		V _{ISET}	-0.3 ~ V _{IN} +0.3 or +6.5 ^(*)	V
BAT Pin Current		I _{BAT}	1600	mA
Power Dissipation	SOP-8FD	Pd	300	mW
			1500 (PCB mounted)	
	USP-6EL	Pd	120	
			750 (PCB mounted)	
Operating Ambient Temperature		T _{opr}	-40 ~ +85	°C
Storage Temperature		T _{stg}	-55 ~ +125	°C

Each rating voltage is based on the V_{SS}.

^(*) Either of lower one, V_{IN}+0.3 or +6.5, is applicable.

■ ELECTRICAL CHARACTERISTICS

 Unless otherwise stated, $V_{IN}=5.0V$, $V_{THIN}=1.0V$, $C_{IN}=C_L=1\mu F$, $T_a=25^\circ C$

PARAMETER	SYMBOL	CONDITION	MIN.	TYP.	MAX.	UNIT	CIRCUIT
Operating Voltage Range	V_{IN}		4.5	5	6	V	-
Supply Current ⁽¹⁾	I_{SS}	$V_{BAT} = 3.5 V$	-	110	-	μA	①
Standby Current	I_{STB}	$V_{BAT} = 4.3 V$, $I_{STB} = I_{IN} - I_{THIN}$	-	60	-	μA	①
V_{IN} - V_{BAT} Shut-down Voltage	V_{IBSD}	$V_{BAT} = 4.1 V$	-	40	-	mV	②
Shut-down Hysteresis Voltage ⁽¹⁾	$V_{IBSDHYS}$		-	60	-	mV	②
UVLO Voltage	V_{UVLO}		3.6	3.8	4	V	②
UVLO Hysteresis Voltage ⁽¹⁾	$V_{UVLOHYS}$		-	200	-	mV	②
Trickle Charge Voltage	V_{TRK}		2.8	2.9	3	V	②
Trickle Charge Hysteresis Voltage ⁽¹⁾	V_{TRKHYS}		-	100	-	mV	②
Trickle Charge Current (Min.) ⁽¹⁾	I_{TRKI}	$R_{ISET} = 41.2 k\Omega$, $V_{BAT} = 2.4 V$	-	21	-	mA	②
Trickle Charge Current	I_{TRK}	$R_{ISET} = 20 k\Omega$, $V_{BAT} = 2.4 V$	28.5	41	50	mA	②
Trickle Charge Current (Max.) ⁽¹⁾	I_{TRKA}	$R_{ISET} = 8.87 k\Omega$, $V_{BAT} = 2.4 V$	-	85	-	mA	②
CV Charge Voltage	V_{BAC}	$I_{BAT} = 60 mA$	4.17	4.2	4.23	V	③
		$V_{THIN} = V_{THIN_open} \times V_{T45}^{(2)}$	4.02	4.05	4.08	V	③
CC Charge Current (Min.) ⁽¹⁾	I_{BACI}	$R_{ISET} = 41.2 k\Omega$, $V_{BAT} = 3.1 V$	-	200	-	mA	②
		$R_{ISET} = 41.2 k\Omega$, $V_{BAT} = 3.1 V$ $V_{THIN} = V_{THIN_open} \times V_{T10}^{(3)}$	-	92	-	mA	②
CC Charge Current	I_{BAC}	$R_{ISET} = 20 k\Omega$, $V_{BAT} = 3.1 V$	325	382	438	mA	②
		$R_{ISET} = 20 k\Omega$, $V_{BAT} = 3.1 V$ $V_{THIN} = V_{THIN_open} \times V_{T10}^{(3)}$	152	176	203	mA	②
CC Charge Current (Max.) ⁽¹⁾	I_{BACA}	$R_{ISET} = 8.87 k\Omega$, $V_{BAT} = 3.1 V$	-	800	-	mA	②
		$R_{ISET} = 8.87 k\Omega$, $V_{BAT} = 3.1 V$ $V_{THIN} = V_{THIN_open} \times V_{T10}^{(3)}$	-	368	-	mA	②
Charge Completion Current (Min) ⁽¹⁾	I_{FINI}	$R_{ISET} = 41.2 k\Omega$	-	20	-	mA	③
Charge Completion Current	I_{FIN}	$R_{ISET} = 20 k\Omega$	32	47	62	mA	③
Charge Completion Current (Max) ⁽¹⁾	I_{FINA}	$R_{ISET} = 8.87 k\Omega$	-	98	-	mA	③
Over Voltage Protection Threshold	V_{COV}		4.3	4.45	4.6	V	②
Over Current Protection Threshold ⁽¹⁾	I_{COP}	$R_{ISET} = 2.8 k\Omega$	-	1200	-	mA	②
Driver ON Resistance	R_{ON}	$V_{IN} = 4.1 V$, $I_{BAT} = 200 mA$	-	350	550	m Ω	③
Driver Leakage Current	I_{LEAK}	$V_{IN} = 6.0 V$, $V_{BAT} = 0 V$	-	-	1	μA	⑤
BAT Pin Reverse Current	I_{REV}	$V_{IN} = 0 V$, $V_{BAT} = 4.5 V$	2.0	4.5	9.0	μA	⑥
BAT Pin Pull-down Current	I_{BATPD}	$V_{IN} = 5.0 V$, $V_{BAT} = 4.3 V$	1.5	3.0	7.0	μA	②
Recharge Voltage (XC6804xxE)	V_{RCHG}		3.7	3.9	4.1	V	②
		$V_{THIN} = V_{THIN_open} \times V_{T45}^{(2)}$	3.55	3.75	3.95	V	②

⁽¹⁾ Design target

⁽²⁾ Applicable only for the XC6804x4

⁽³⁾ Applicable only for the XC6804x3 and the XC6804x4

ELECTRICAL CHARACTERISTICS

Unless otherwise stated, $V_{IN}=5.0V$, $V_{THIN}=1.0V$, $R_{ISET}=41.2k\Omega$, $C_{IN}=C_L=1\mu F$, $T_a=25^\circ C$

PARAMETER	SYMBOL	CONDITION	MIN.	TYP.	MAX.	UNIT	CIRCUIT
THIN Pin Open Voltage	V_{THIN_open}		1.94	2.0	2.06	V	⑤
Battery Connect Detection	V_{TD}		77	80	83	% ⁽²⁾	②
Battery Connect Detection Hysteresis ⁽¹⁾	V_{TDH}	At temperature fall	-	3	-	% ⁽²⁾	②
Thermistor Detection at 0°C	V_{T0}		71.13	73.13	75.13	% ⁽²⁾	②
Thermistor Detection Hysteresis at 0°C ⁽¹⁾	V_{T0H}	At temperature rise	-	2.18	-	% ⁽²⁾	②
Thermistor Detection at 10°C ⁽³⁾	V_{T10}		62.19	64.19	66.19	% ⁽²⁾	②
Thermistor Detection Hysteresis at 10°C ⁽¹⁾	V_{T10H}	At temperature rise	-	2.38	-	% ⁽²⁾	②
Thermistor Detection at 45°C	V_{T45}		30.96	32.96	34.96	% ⁽²⁾	②
Thermistor Detection Hysteresis at 45°C ⁽¹⁾	V_{T45H}	At temperature fall	-	1.94	-	% ⁽²⁾	②
Thermistor Detection at 60°C ⁽⁴⁾	V_{T60}		21.16	23.16	25.16	% ⁽²⁾	②
Thermistor Detection Hysteresis at 60°C ⁽¹⁾ ⁽⁴⁾	V_{T60H}	At temperature fall	-	1.47	-	% ⁽²⁾	②
THIN Pin Connected Resistance	R_{THIN}	$V_{THIN} = 0 V$	9.8	10	10.2	k Ω	⑤
Trickle Charge Hold Time	t_{TRK}		-	2	-	hr	②
Main Charge Hold Time	t_{CHG}		-	10	-	hr	②
CSO Pin OFF Current	I_{CSO_OFF}	$V_{CSO} = 6.0 V$	-	-	1	μA	⑦
CSO Pin ON Voltage	V_{CSO}	$I_{CSO} = 10 mA$	-	-	0.5	V	④
Thermal Shut-Down Detection Temperature ⁽¹⁾	T_{TSD}		-	115	-	°C	②
Thermal Shut-Down Detection Temperature Hysteresis ⁽¹⁾	T_{TSDH}		-	10	-	°C	②
CSO Frequency (XC6804A)	f_{CSO}		0.75	1	1.25	kHz	②

⁽¹⁾ Design target

⁽²⁾ The comparator detect voltage and hysteresis width are indicated as percentages of the THIN pin open voltage, V_{THIN_open} , (taken to be 100%)

$$V_{Txx} = V_{Txx}' / V_{THIN_open}$$

(V_{Txx}' : Voltage when the external voltage applied to the THIN pin sweeps and the IC internal comparator inverts)

⁽³⁾ Applicable only for the XC6804x3 and the XC6804x4

⁽⁴⁾ Applicable only for the XC6804x4

TEST CIRCUITS

1) Test Circuit ①



2) Test Circuit ②



3) Test Circuit ③



4) Test Circuit ④



5) Test Circuit ⑤

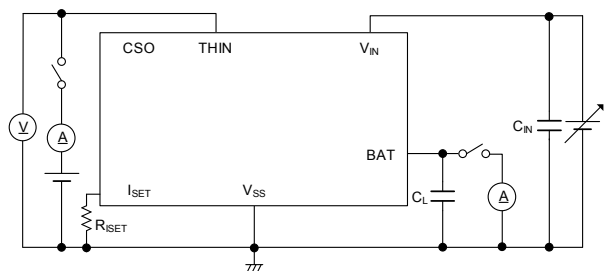

6) Test Circuit ⑥

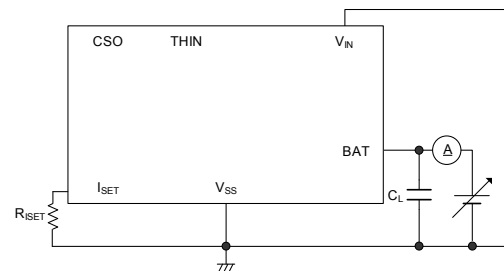

7) Test Circuit ⑦



TYPICAL APPLICATION CIRCUIT



【Recommended parts】

	MANUFACTURE	PRODUCT NUMBER	VALUE
C _{IN}	TAIYO YUDEN	LMK107BJ105KA	1µF/10V
C _L	TAIYO YUDEN	LMK107BJ105KA	1µF/10V
NTC	Murata	NCP15XH103F03RC	Resistance: 10kΩ @ 25°C B-constant (25 - 50°C): 3380K
R _{ISET}			8.87~ 41.2kΩ

OPERATIONAL EXPLANATION

<Charging function>

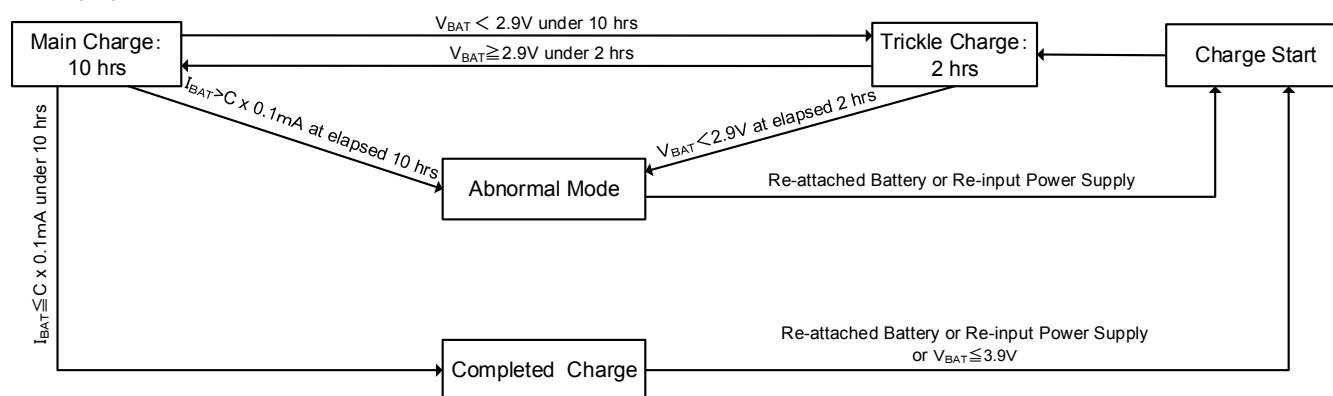

● Charging start

When a thermistor is connected to the THIN pin after a voltage is applied to the power input pin (①), or when a voltage is applied to the power input pin after a thermistor is connected to the THIN pin (②), the power on reset function activates and initializes the internal counter. After 200ms elapses in the case of ①, or 150ms in the case of ②, charging starts.

● Trickle charging: Less than 2 hours

Trickle charging determines if main charging of the Li-ion battery is possible. The Li-ion battery is charged at a trickle charge current that is one-tenth the charge current set with the external resistor R_{ISET} . If the BAT pin voltage V_{BAT} is above 2.9V in the charging start state, trickle charging takes place for 1ms and then main charging begins. If V_{BAT} is less than 2.9V, trickle charging takes place, and main charging begins 50ms after 2.9V is detected. If the BAT pin voltage is less than 2.9V after 2 hours, the IC changes to the error state and stops charging the Li-ion battery. In addition, the error in the trickle charge current increases if V_{BAT} drops below about 1V.

● Main charging: Less than 10 hours

When the condition for transition from trickle charging is satisfied, it is determined that rapid charging of the Li-ion battery is possible and the IC changes to the main charging state. In main charging, the IC charges a Li-ion battery at a CC charge current that is set with the external resistor R_{ISET} . When the BAT pin voltage rises to the CV charge voltage in less than 10 hours and the charge current drops to the charging completed current, and after 50ms elapses, the IC changes to the charging completed state and charging stops. If the charge current is higher than the charging completed current after 10 hours, the IC changes to the error state and stops charging.

● Charging completed

When the charge current reaches the charge completion current, which is one-tenth the charge current set with the external resistor R_{ISET} , and after 50ms elapses, the IC changes to charging completed and stops charging the Li-ion battery. At this time, the charge status output pin changes from ON to OFF. On the XC6804xxE, when the BAT pin voltage (V_{BAT}) falls from the charge completion state to the recharge voltage (V_{RCHG}) or less, charging automatically restarts. When a voltage is reapplied to the power input pin or a Li-ion battery is reconnected to the BAT pin in the charging completed state, the IC starts and charging begins.

● Error state

If it is determined that charging is abnormal in any state, the IC treats this as an error state and stops charging. When the power is turned off and then on, or the battery is reinserted, the IC starts up gain and starts charging. An error state occurs if 2 hours elapses during trickle charging, if 10 hours elapses during main charging, or if charging overvoltage or charging overcurrent is detected.

● Charging status output pin, CSO

The charge status output pin turns ON by Nch open drain output during trickle charging and main charging, and turns OFF after charging is completed. An LED can be connected to enable confirmation of charging by illumination of the LED. If an abnormal condition is detected, the charge status output pin repeats ON-OFF at 1kHz on the XC6804A, and turns off on the XC6804B. An error state indicates a state in which 2 hours have elapsed during trickle charging, 10 hours have elapsed during main charging, or charging over-voltage or charging over-current is detected.

● Charge current

The charge current I_{CHG} of this IC can be set in the range 200mA to 800mA by means of the external resistance R_{ISET} . The relation between R_{ISET} and I_{CHG} is approximated by the equation below.

$$R_{ISET} \text{ (k}\Omega\text{)} = 15950 \times I_{CHG}^{-1.122} \text{ (mA)}$$

(*1) The XC6804xxD does not have the recharge function.

■ OPERATIONAL EXPLANATION (Continued)

● IC temperature monitoring function

In order to prevent destruction due to IC heat generation as well as abnormal charging due to thermal runaway, a thermal shutdown circuit is incorporated into the IC. If the chip temperature rises to 115°C or higher and after 50ms elapses, this function turns off the output driver and stops charging. When 50ms elapse with the chip temperature 105°C or less, this function returns the IC to the main charging state and starts charging. Even when charging is stopped by this function, the t_{TRK} and t_{CHG} counts are continued.

● Dropout voltage monitoring function

To prevent reverse current from the Li-ion battery to the battery charger, this function monitors the dropout voltage between the BAT pin voltage (V_{BAT}) and power input pin voltage (V_{IN}). When the V_{IN} falls to $V_{BAT} + 40mV$, the function turns off the output driver and switches the backgating connection from the power pin to the BAT pin. When V_{IN} rises higher than $V_{BAT} + 0.1V$, this function is released, the output driver turns ON, the driver backgate connects to the power pin and resumes charging, and the charge status output pin turns ON. Even when charging is stopped by this function, the t_{CHG} count is continued. When charging is completed, the charging status output pin maintains the OFF state even if the function activates due to disconnection of the input power or otherwise.

● UVLO function

A UVLO function is incorporated. If the power input pin voltage, V_{IN} falls to 3.8V or lower during charging, this function turns off the output driver and stops charging. In addition, the charge status output pin changes to OFF. When the V_{IN} rises to 4V or higher, the IC starts up and charging begins. This function also detects voltage application to the power input pin.

● Charge over-voltage monitoring function

To prevent charging of a battery in the over-voltage state, this function stops charging if the BAT pin voltage rises to 4.45V or higher and 50ms elapses.

At this time, the charge status output pin repeats ON-OFF at 1kHz on the XC6804A, and turns off on the XC6804B. When voltage is reapplied to the power input pin or the Li-ion battery is reconnected to the BAT pin, the IC starts up and charging begins.

● Charge over-current monitoring function

To prevent charging of a battery by excessive current, this function stops charging if the charge current rises to 1200 mA or higher.

At this time, the charge status output pin repeats ON-OFF at 1 kHz on the XC6804A, and turns off on the XC6804B. When voltage is reapplied to the power input pin or the Li-ion battery is reconnected to the BAT pin, the IC starts up and charging begins.

● Recharge function

With the completion of charging, when the NTC thermistor temperature is 0°C or higher and less than 45°C, and the BAT pin voltage (V_{BAT}) falls to 3.9 V or less, charging resumes. (charging is resumed 150ms after the charge start state is entered.)

On the XC6804x4, if the NTC thermistor temperature is 45°C or higher and less than 60°C, charging automatically resumes when the voltage falls to 3.75 V or less. This function is equipped only in the XC6804xxE, not in the XC6804xxD.

■ OPERATIONAL EXPLANATION (Continued)

● Li-ion battery temperature monitoring function

The IC monitors the Li-ion battery temperature during charging by means of an NTC thermistor (“thermistor” below) connected to the THIN pin. The charge voltage V_{BAC} and the charge current I_{BAT} are controlled based on the Li-ion battery temperature as shown below to enable safe charging. The charge state changes 50 ms after the Li ion battery temperature reaches each of the change points.

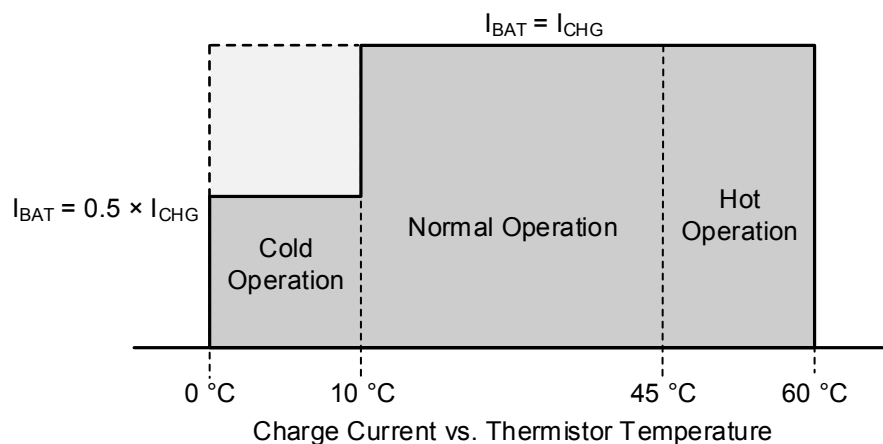

● XC6804x4 (4 temperatures monitoring)

Cold Operation

When $0^{\circ}\text{C} < \text{NTC Temperature} \leq 10^{\circ}\text{C}$, the charge current is limited to $I_{\text{CHG}} \times 0.5$.⁽¹⁾

When $\text{NTC Temperature} \leq 0^{\circ}\text{C}$, charging stops.⁽²⁾

Normal Operation

When $10^{\circ}\text{C} < \text{NTC Temperature} < 45^{\circ}\text{C}$, charging takes place with the charge current I_{CHG} and the charge voltage at 4.2 V.⁽¹⁾

Hot Operation

When $45^{\circ}\text{C} \leq \text{NTC Temperature} < 60^{\circ}\text{C}$, the charge voltage changes to 4.05 V and charging continues.⁽¹⁾

When $60^{\circ}\text{C} \leq \text{Thermistor Temperature}$, charging stops.⁽²⁾

● XC6804x3 (3 temperatures monitoring)

Comparing to the XC6804x4, the XC6804x3 does not monitor at 60°C and charging stops at $45^{\circ}\text{C} \leq \text{Thermistor Temperature}$.⁽²⁾

● XC6804x2 (2 temperatures monitoring)

In contrast to the XC6804x4, the XC6804x2 does not have 10°C and 60°C monitoring, and stops charging when Thermistor Temperature $\leq 0^{\circ}\text{C}$ and when Thermistor Temperature $\geq 45^{\circ}\text{C}$.⁽²⁾

In addition, when $0^{\circ}\text{C} < \text{Thermistor Temperature} \leq 10^{\circ}\text{C}$, the charge current does not change from I_{CHG} .⁽¹⁾

⁽¹⁾ During trickle charging, the charge current is limited to $I_{\text{CHG}} \times 0.1$.

⁽²⁾ Even when charging is stopped, t_{TRK} count and t_{CHG} count are continued and the charge status output pin maintains the ON state.

The thermistor temperature detection of this IC conforms to the characteristics of the NCP15XH103F03RC of Murata Manufacturing Co., Ltd.

OPERATIONAL EXPLANATION (Continued)

Timing chart example

XC6804x4



(*) With regard to the detail of the Cold Operation and Hot Operation, please refer to “Li-ion battery temperature monitoring function” of the Operational Explanation on page 11.

■ NOTES ON USE

1. For temporary, transitional voltage drop or voltage rising phenomenon, the IC is liable to malfunction should the ratings be exceeded.
2. Where wiring impedance is high, operations may become unstable. Please strengthen V_{IN} and BAT wiring in particular.
3. Please wire the C_{IN} , C_L and charge current setting resistor to the IC as close as possible.
4. Do not connect anything other than a resistance for setting the charge current to the I_{SET} pin.
5. Torex places an importance on improving our products and their reliability. We request that users incorporate fail-safe designs and post-aging protection treatment when using Torex products in their systems.
6. This IC uses an external thermistor to detect and control temperature with high accuracy. Please sufficiently test the position of the external thermistor to ensure that it enables accurate temperature detection.
7. Reversing the polarity of the battery may cause destruction and is extremely dangerous. Never reverse the polarity of the battery.
8. Short-circuiting to neighboring pins may cause malfunctioning and destruction. Exercise sufficient caution when mounting and using the IC.
9. If a large ripple voltage occurs at the V_{IN} pin, the IC may malfunction. Please test thoroughly.
10. Taking the temperature characteristics and the dispersion into consideration, please set the charge current not to exceed the range of 200mA to 800mA.
11. If the I_{SET} pin is shorted to the GND, there is a possibility that the IC is destroyed before the over-current monitor function is activated.
12. When V_{BAT} is 1V or less, the error range of the trickle charge current becomes big. When $V_{IN} - V_{BAT}$ voltage is high in particular, please pay attention when using as there are possibilities that a large trickle current flows.
13. In case that the impedance between BAT pin and Li-ion battery is high at the CV charging under the low temperature, there are possibilities that V_{BAT} oscillates and charge error takes place, so please place the Li-ion battery as close to the IC as possible.

TYPICAL PERFORMANCE CHARACTERISTICS

(1) CC Charge Current vs. External Resistor (Normal Operation)



(2) CC Charge Current vs. Ambient Temperature (Normal Operation)



(3) CC Charge Current vs. Ambient Temperature (Cold Operation)

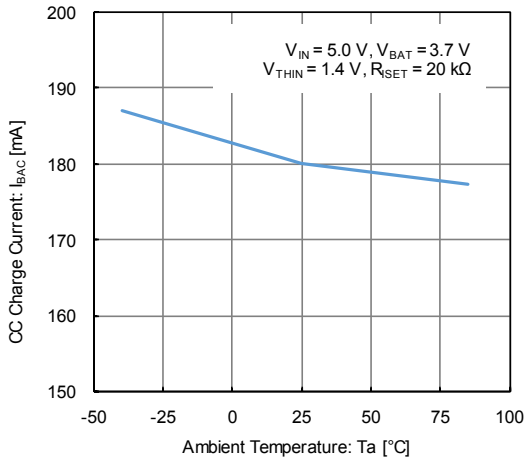

(4) Trickle Charge Current vs. Ambient Temperature

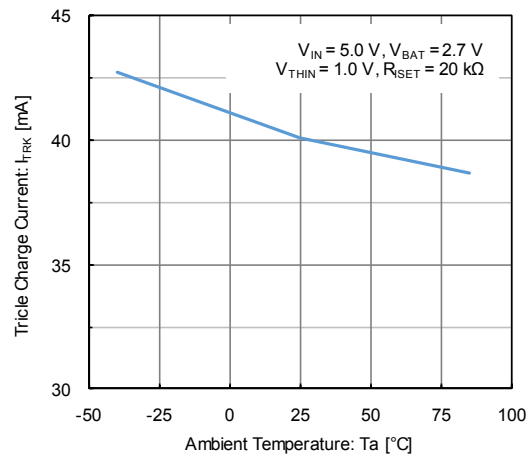

(5) Charge Completion Current vs. Ambient Temperature



TYPICAL PERFORMANCE CHARACTERISTICS

(6) CV Charge Voltage vs. Charge Current (Normal Operation)



(7) CV Charge Voltage vs. Charge Current (Hot Operation)



(8) CC Charge Current vs. BAT Pin Voltage ($R_{ISET} = 42.1\text{ k}\Omega$, Normal Operation)



(9) CC Charge Current vs. BAT Pin Voltage ($R_{ISET} = 42.1\text{ k}\Omega$, Cold Operation)

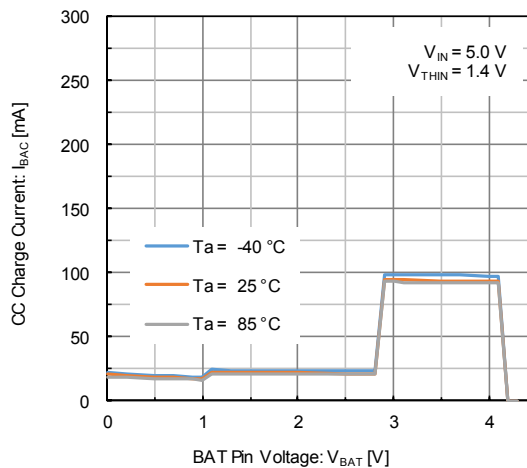

(10) CC Charge Current vs. BAT Pin Voltage ($R_{ISET} = 20\text{ k}\Omega$, Normal Operation)

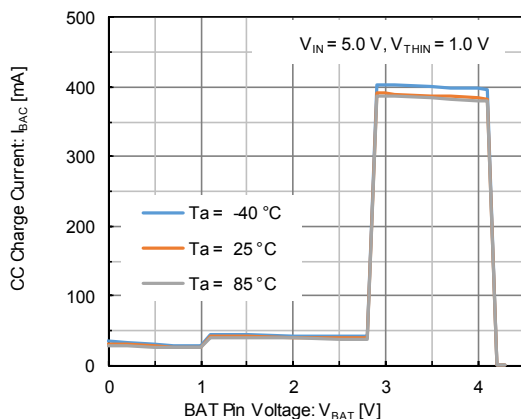

(11) CC Charge Current vs. BAT Pin Voltage ($R_{ISET} = 20\text{ k}\Omega$, Cold Operation)



TYPICAL PERFORMANCE CHARACTERISTICS

(12) CC Charge Current vs. BAT Pin Voltage
($R_{SET} = 8.6 \text{ k}\Omega$, Normal Operation)



(13) CC Charge Current vs. BAT Pin Voltage
($R_{SET} = 8.6 \text{ k}\Omega$, Cold Operation)

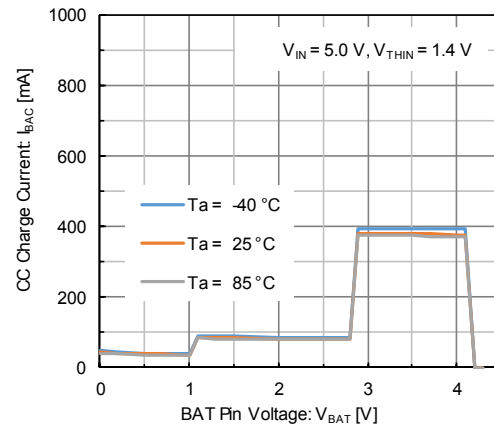

(14) Supply Current vs. Ambient Temperature

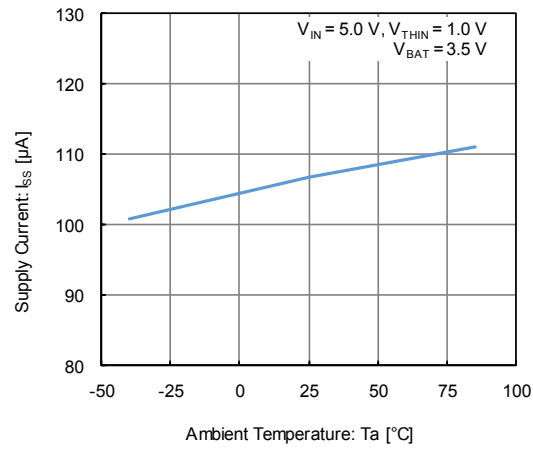

(15) Standby Current vs. Ambient Temperature

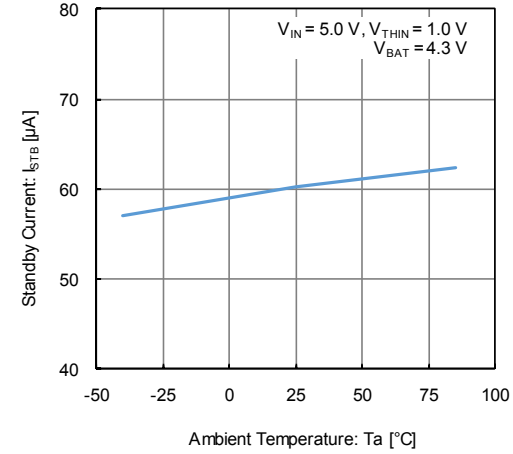

(16) VIN - VBAT Shut-down Voltage vs. Ambient Temperature

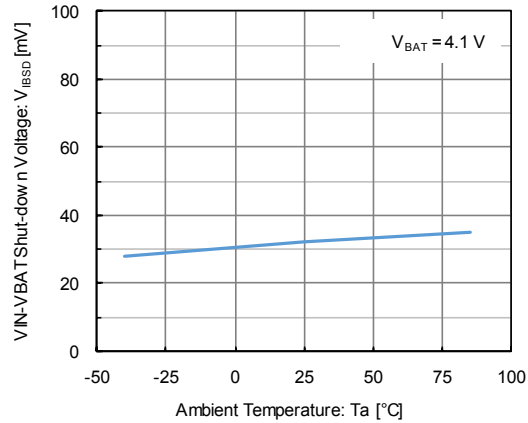

(17) Shut-down Hysteresis Voltage vs. Ambient Temperature

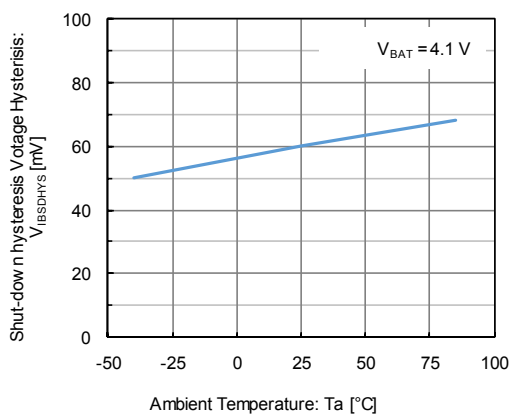

TYPICAL PERFORMANCE CHARACTERISTICS

(18) UVLO Voltage vs. Ambient Temperature



(19) UVLO Hysteresis Voltage vs. Ambient Temperature

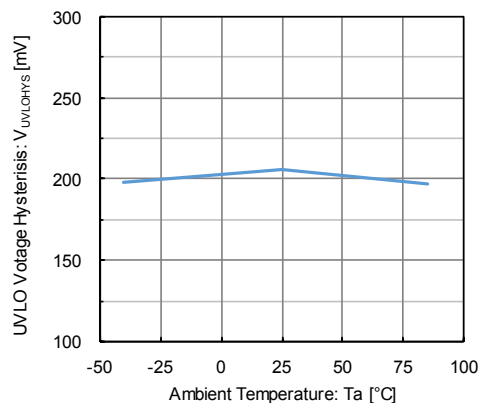

(20) Trickle Charge Voltage vs. Ambient Temperature



(21) Trickle Charge Hysteresis Voltage vs. Ambient Temperature



(22) Over Voltage Protection Threshold vs. Ambient Temperature



(23) Over Current Protection Threshold vs. Ambient Temperature



TYPICAL PERFORMANCE CHARACTERISTICS

(24) Driver ON Resistance vs. Ambient Temperature



(25) Driver Leakage Current vs. Ambient Temperature



(26) BAT Pin Reverse Current vs. Ambient Temperature

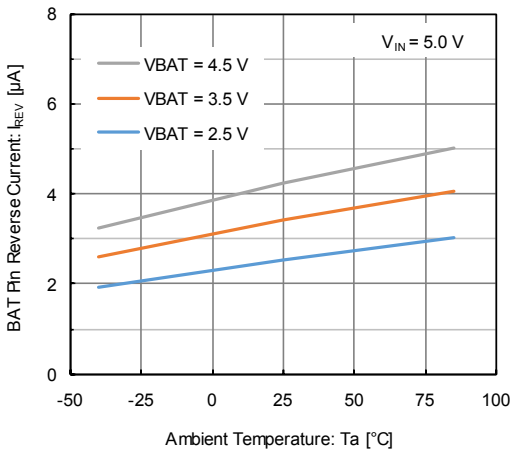

(27) BAT Pin Pull-down Current vs. Ambient Temperature

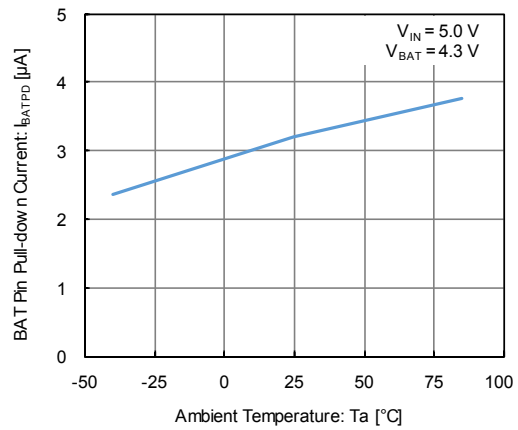

(28) Recharge Voltage vs. Ambient Temperature (Normal Operation)



(29) Recharge Voltage vs. Ambient Temperature (Hot Operation)



TYPICAL PERFORMANCE CHARACTERISTICS

(30) THIN Pin Open Voltage vs. Ambient Temperature

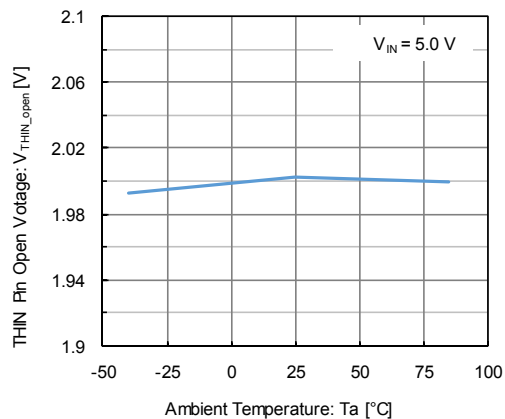

(31) THIN Pin Connected Resistance vs. Ambient Temperature

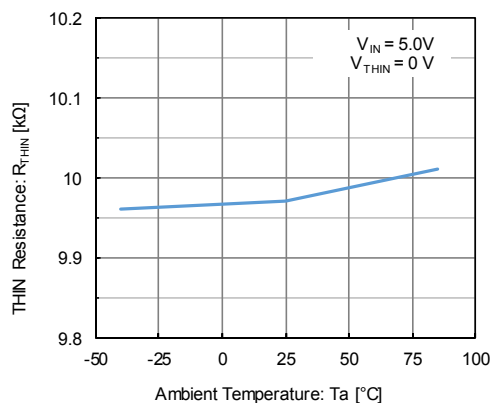

(32) Battery Connect Detection Voltage vs. Ambient Temperature

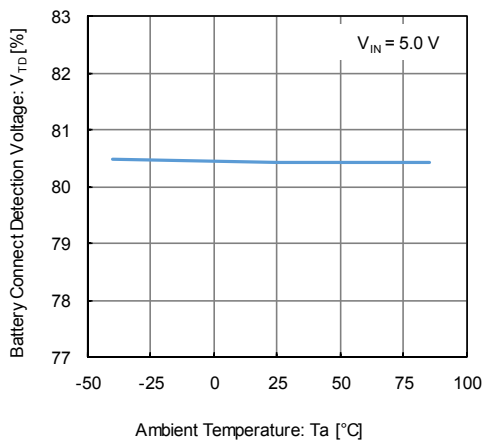

(33) Battery Connect Detection Hysteresis Voltage vs. Ambient Temperature

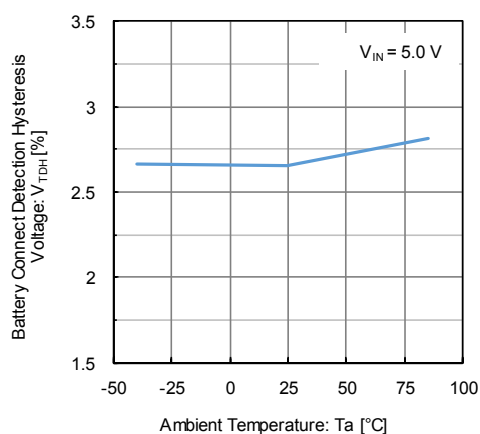

(34) Thermistor Detection at 0°C vs. Ambient Temperature

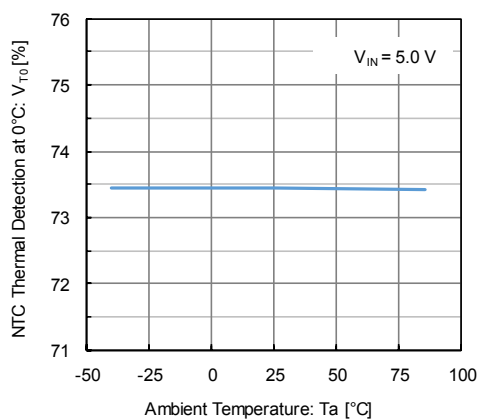

(35) Thermistor Detection Hysteresis at 0°C vs. Ambient Temperature

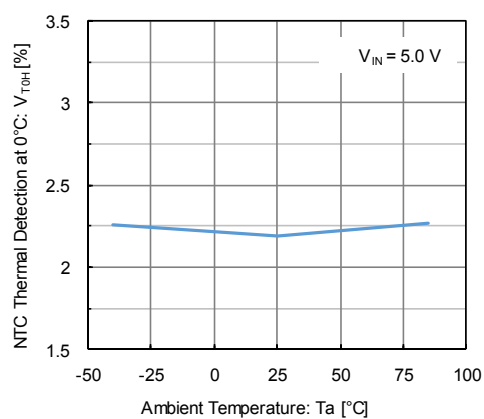

TYPICAL PERFORMANCE CHARACTERISTICS

(36) Thermistor Detection at 10°C vs. Ambient Temperature

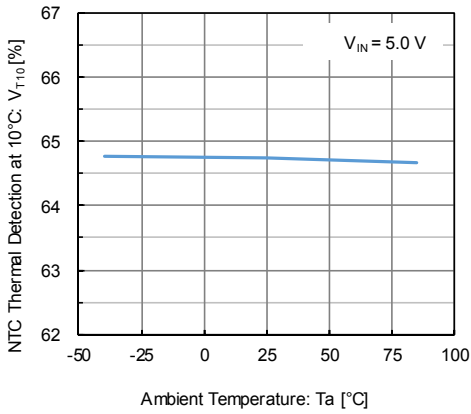

(37) Thermistor Detection Hysteresis at 10°C vs. Ambient Temperature



(38) Thermistor Detection at 45°C vs. Ambient Temperature

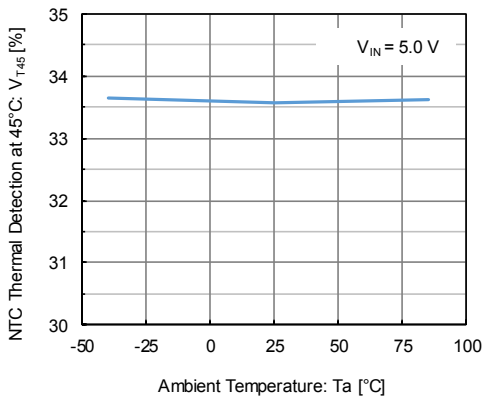

(39) Thermistor Detection Hysteresis at 45°C vs. Ambient Temperature



(40) Thermistor Detection at 60°C vs. Ambient Temperature

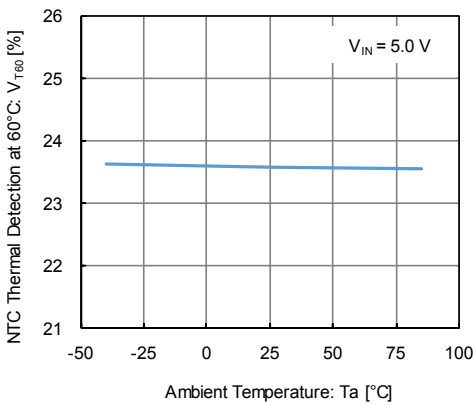

(41) Thermistor Detection Hysteresis at 60°C vs. Ambient Temperature

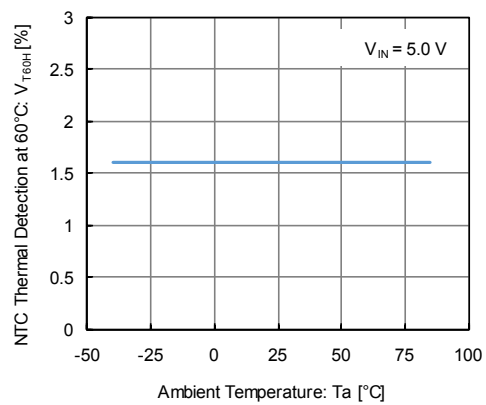

TYPICAL PERFORMANCE CHARACTERISTICS

(42) CSO Pin ON Voltage vs. Ambient Temperature

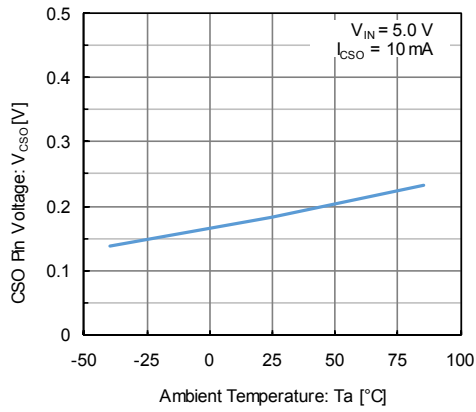

(43) CSO Pin OFF Current vs. Ambient Temperature

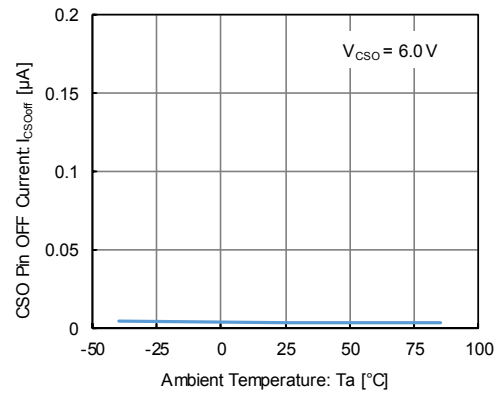

(44) CSO Frequency vs. Ambient Temperature



XC6804 Series

PACKAGING INFORMATION

● SOP-8FD (unit: mm)



● SOP-8FD Reference pattern layout (unit: mm)



● SOP-8FD Reference metal mask design (unit: mm)

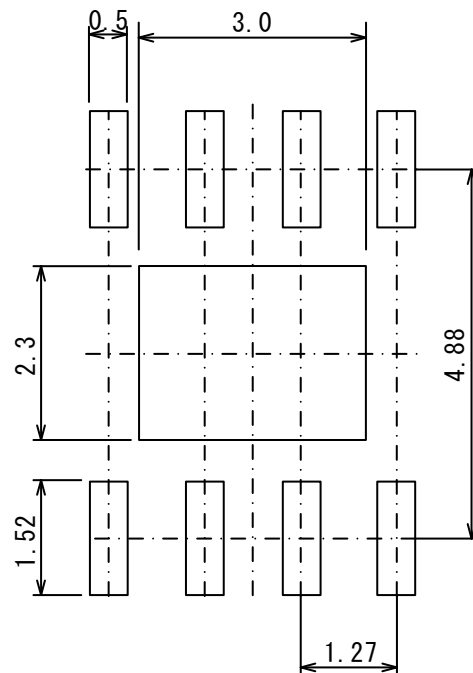

■ **PACKAGING INFORMATION (Continued)**

- USP-6EL (unit: mm)

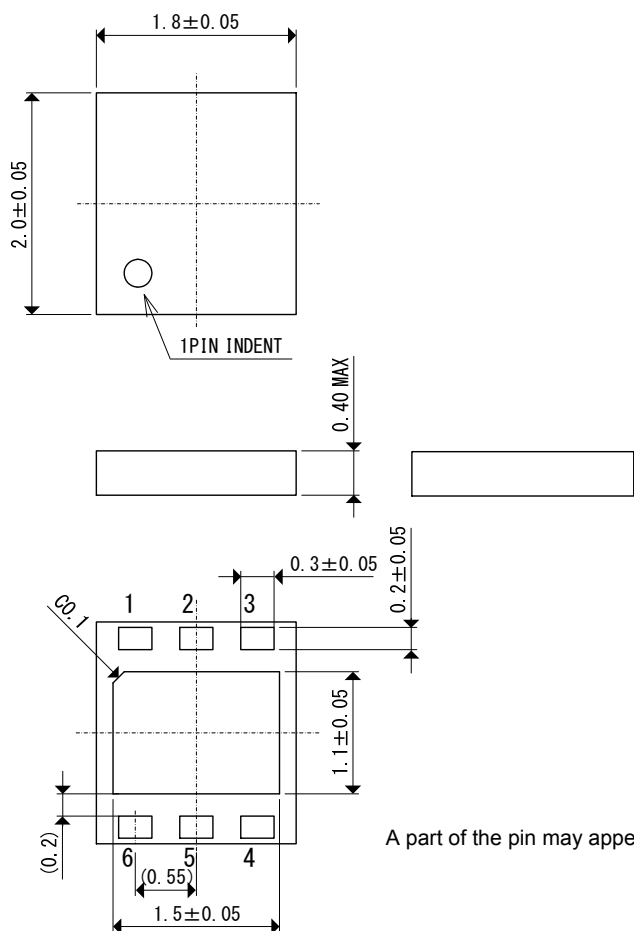

A part of the pin may appear from the side of the package because of its structure.

- USP-6EL Reference pattern layout (unit: mm)

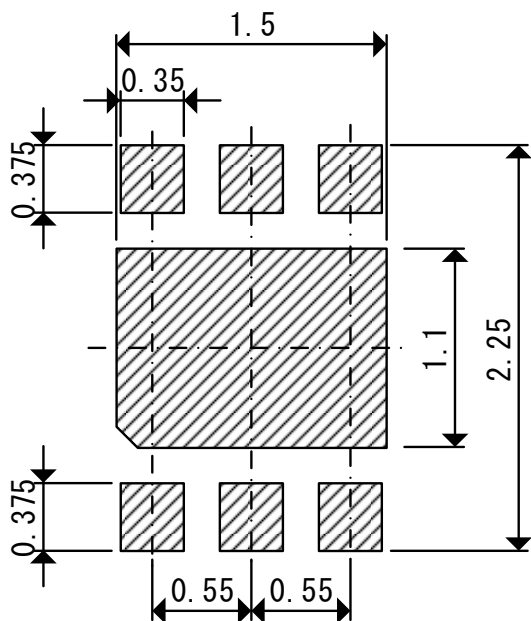

- USP-6EL Reference metal mask design (unit: mm)

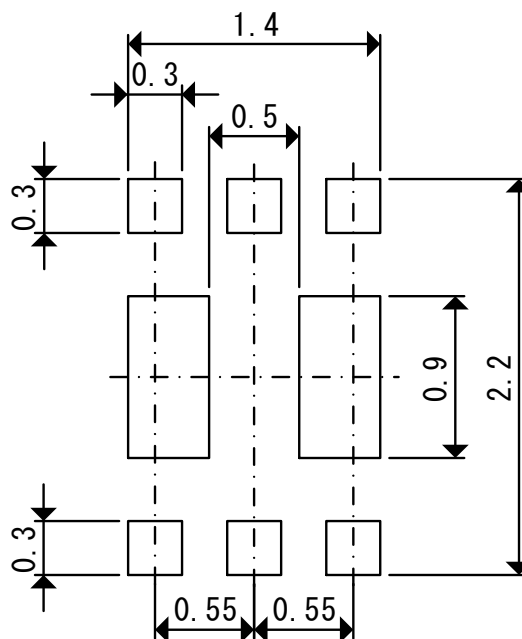

● SOP-8FD Power Dissipation

Power dissipation data for the SOP-8FD is shown in this page.
 The value of power dissipation varies with the mount board conditions.
 Please use this data as the reference data taken in the following condition.

1. Measurement Condition

- Condition: Mount on a board
- Ambient: Natural convection
- Soldering: Lead (Pb) free
- Board: Dimensions 40 x 40 mm
 (1600 mm² in one side)
- Copper (Cu) traces occupy 50% of the board area in top and back faces
- Package heat-sink is tied to the copper traces
- Material: Glass Epoxy (FR-4)
- Thickness: 1.6mm
- Through-hole: 4 x 0.8 Diameter

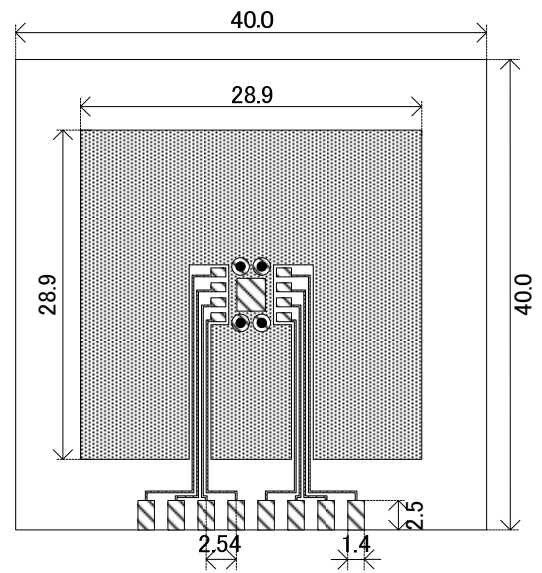

Evaluation Board (Unit : mm)

2. Power Dissipation vs. Ambient Temperature

Board Mount ($T_J \text{ max} = 125^\circ\text{C}$)

Ambient Temperature ($^\circ\text{C}$)	Power Dissipation P_d (mW)	Thermal Resistance ($^\circ\text{C}/\text{W}$)
25	1500	66.67
85	600	

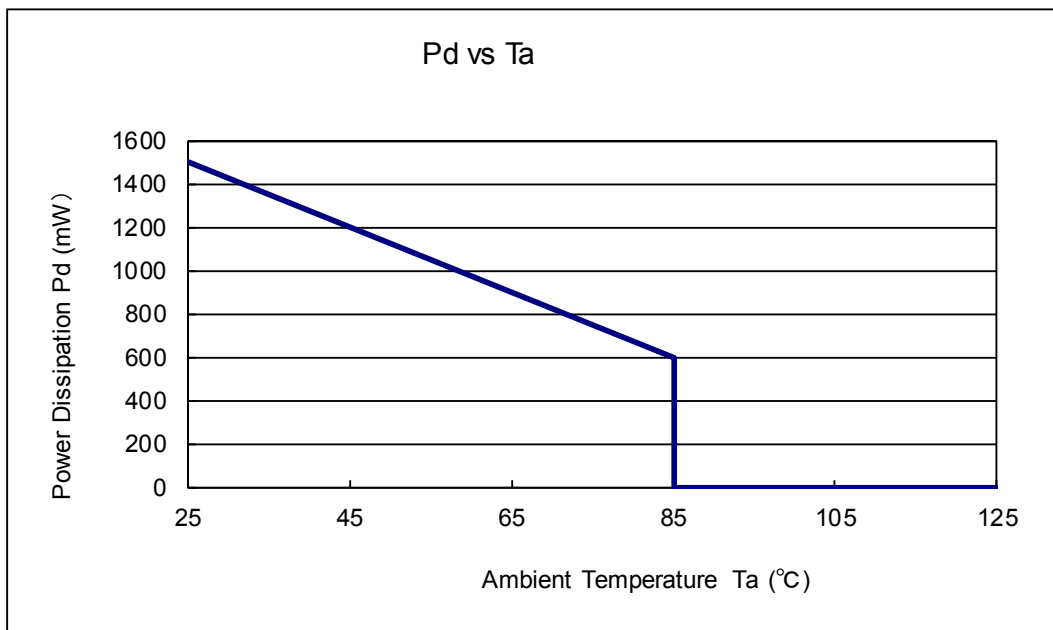

● **USP-6EL(DAF) Power Dissipation**

Power dissipation data for the USP-6EL(DAF) is shown in this page.
The value of power dissipation varies with the mount board conditions.
Please use this data as the reference data taken in the following condition.

1. Measurement Condition

- Condition : Mount on a board
- Ambient : Natural convection
- Soldering : Lead (Pb) free
- Board : Dimensions 40 x 40 mm
(1600 mm² in one side)
Copper (Cu) traces occupy 50% of the board area in top and back faces
Package heat-sink is tied to the copper traces
- Material : Glass Epoxy (FR-4)
- Thickness : 1.6mm
- Through-hole : 4 x 0.8 Diameter



Evaluation Board (Unit : mm)

2. Power Dissipation vs. Ambient Temperature

Board Mount ($T_j \text{ max} = 125^\circ\text{C}$)

Ambient Temperature ($^\circ\text{C}$)	Power Dissipation Pd (mW)	Thermal Resistance ($^\circ\text{C}/\text{W}$)
25	750	133.33
85	300	



MARKING RULE

● SOP-8FD



① represents product series

MARK	PRODUCT SERIES
4	XC6804*****-G

② represents charge status output on abnormal mode

MARK	PRODUCT SERIES
0	XC6804A*****-G
1	XC6804B*****-G

③ represents battery temperature monitor function and recharge function

MARK	CHARGE STATUS OUTPUT ON ABNORMAL MODE	BATTERY TEMPERATURE MONITOR FUNCTION	PRODUCT SERIES
H	2 Temperature Monitor	Enable	XC6804*2E**-G
F	2 Temperature Monitor	Disable	XC6804*2D**-G
E	3 Temperature Monitor	Enable	XC6804*3E**-G
D	3 Temperature Monitor	Disable	XC6804*3D**-G
C	4 Temperature Monitor	Enable	XC6804*4E**-G
B	4 Temperature Monitor	Disable	XC6804*4D**-G

● USP-6EL



④,⑤ represents production lot number

01 to 09, 0A to 0Z, 11 to 9Z, A1 to A9, AA to AZ, B1 to ZZ repeated
(G, I, J, O, Q, W excluded)

*No character inversion used.

1. The product and product specifications contained herein are subject to change without notice to improve performance characteristics. Consult us, or our representatives before use, to confirm that the information in this datasheet is up to date.
2. The information in this datasheet is intended to illustrate the operation and characteristics of our products. We neither make warranties or representations with respect to the accuracy or completeness of the information contained in this datasheet nor grant any license to any intellectual property rights of ours or any third party concerning with the information in this datasheet.
3. Applicable export control laws and regulations should be complied and the procedures required by such laws and regulations should also be followed, when the product or any information contained in this datasheet is exported.
4. The product is neither intended nor warranted for use in equipment of systems which require extremely high levels of quality and/or reliability and/or a malfunction or failure which may cause loss of human life, bodily injury, serious property damage including but not limited to devices or equipment used in 1) nuclear facilities, 2) aerospace industry, 3) medical facilities, 4) automobile industry and other transportation industry and 5) safety devices and safety equipment to control combustions and explosions. Do not use the product for the above use unless agreed by us in writing in advance.
5. Although we make continuous efforts to improve the quality and reliability of our products; nevertheless Semiconductors are likely to fail with a certain probability. So in order to prevent personal injury and/or property damage resulting from such failure, customers are required to incorporate adequate safety measures in their designs, such as system fail safes, redundancy and fire prevention features.
6. Our products are not designed to be Radiation-resistant.
7. Please use the product listed in this datasheet within the specified ranges.
8. We assume no responsibility for damage or loss due to abnormal use.
9. All rights reserved. No part of this datasheet may be copied or reproduced unless agreed by Torex Semiconductor Ltd in writing in advance.

TOREX SEMICONDUCTOR LTD.

Компания «Life Electronics» занимается поставками электронных компонентов импортного и отечественного производства от производителей и со складов крупных дистрибьюторов Европы, Америки и Азии.

С конца 2013 года компания активно расширяет линейку поставок компонентов по направлению коаксиальный кабель, кварцевые генераторы и конденсаторы (керамические, пленочные, электролитические), за счёт заключения дистрибьюторских договоров

Мы предлагаем:

- Конкуренспособные цены и скидки постоянным клиентам.
- Специальные условия для постоянных клиентов.
- Подбор аналогов.
- Поставку компонентов в любых объемах, удовлетворяющих вашим потребностям.
- Приемлемые сроки поставки, возможна ускоренная поставка.
- Доставку товара в любую точку России и стран СНГ.
- Комплексную поставку.
- Работу по проектам и поставку образцов.
- Формирование склада под заказчика.
- Сертификаты соответствия на поставляемую продукцию (по желанию клиента).
- Тестирование поставляемой продукции.
- Поставку компонентов, требующих военную и космическую приемку.
- Входной контроль качества.
- Наличие сертификата ISO.

В составе нашей компании организован Конструкторский отдел, призванный помогать разработчикам, и инженерам.

Конструкторский отдел помогает осуществить:

- Регистрацию проекта у производителя компонентов.
- Техническую поддержку проекта.
- Защиту от снятия компонента с производства.
- Оценку стоимости проекта по компонентам.
- Изготовление тестовой платы монтаж и пусконаладочные работы.



Тел: +7 (812) 336 43 04 (многоканальный)
Email: org@lifeelectronics.ru