



# Photocoupler Product Data Sheet CNY17F-1 THRU CNY17F 4 SERIES

Spec No. :DS-70-99-0032  
Effective Date: 08/22/2017  
Revision: 0

**LITE-ON DCC**

**RELEASE**

**BNS-OD-FC001/A4**

## Photocoupler CNY17F series

### 1. DESCRIPTION

#### 1.1 Features

- Current transfer ratio (CTR : MIN. 40% at  $I_F = 10\text{mA}$ ,  $V_{CE} = 5\text{V}$ ,  $T_A = 25^\circ\text{C}$ )
- High collector-emitter voltage  
 $V_{CEO} = 70\text{V}$
- High input-output isolation voltage  
 $V_{iso} = 5,000\text{Vrms}$
- Response time ( $t_r$  : TYP.  $5\mu\text{s}$  at  $V_{CE} = 10\text{V}$ ,  $I_C = 2\text{mA}$ ,  $R_L = 100\Omega$ )
- Dual-in-line package :  
CNY17F-1, CNY17F-2, CNY17F-3, CNY17F-4
- Wide lead spacing package :  
CNY17F-1M, CNY17F-2M, CNY17F-3M, CNY17F-4M
- Surface mounting package :  
CNY17F-1S, CNY17F-2S, CNY17F-3S, CNY17F-4S
- Tape and reel packaging :  
CNY17F-1S-TA, CNY17F-2S-TA, CNY17F-3S-TA, CNY17F-4S-TA  
CNY17F-1S-TA1, CNY17F-2S-TA1, CNY17F-3S-TA1, CNY17F-4S-TA1
- Safety approval
  - \* UL approved (No. E113898)
  - \* TUV approved (No. R9653630)
  - \* CSA approved (No. CA91533-1)
  - \* FIMKO approved (No. 193422-01)
  - \* VDE approved (No. 40015248 )
  - \* BSI approved (No. 9018-9)
  - \* CQC approved (No.CQC11001061921-2)
- Creepage distance > 8.0 mm ; Clearance > 8.0 mm
- The relevant models are the models Approved by VDE according to DIN EN 60747-5-5

Approved Model No.: CNY17F-1-V, CNY17F-2-V, CNY17F-3-V, CNY17F-4-V  
 CNY17F-1M-V, CNY17F-2M-V, CNY17F-3M-V, CNY17F-4M-V  
 CNY17F-1S-V, CNY17F-2S-V, CNY17F-3S-V, CNY17F-4S-V  
 CNY17F-1STA-V, CNY17F-2STA-V, CNY17F-3STA-V, CNY17F-4STA-V  
 CNY17F-1STA1-V, CNY17F-2STA1-V, CNY17F-3STA1-V, CNY17F-4STA1-V

VDE approved No.: 40015248 (According to the specification DIN EN 60747-5-5)

- Operating isolation voltage  $V_{IORM}$  : 850V (Peak)
- Transient voltage  $V_{TR}$  : 6000V (Peak)
- Pollution : 2 (According to VDE 0110-1 : 1997-04)
- Clearances distance (Between input and output) : 7.0mm (MIN.)

## Photocoupler CNY17F series

- Creepage distance (Between input and output) : 7.0mm (MIN.)
- Isolation thickness between input and output : 0.4mm (MIN.)

- Safety limit values Current (I<sub>si</sub>) : 400mA (Diode side)

Power (P<sub>si</sub>) : 700mW (Phototransistor side)

Temperature(T<sub>si</sub>) : 175°C

In order to keep safety electric isolation of photocoupler, please set the protective circuit to keep within safety limit values when the actual application equipment troubled.

- Indication of VDE approval prints "  " on sleeve package.
- RoHS Compliance  
All materials be used in device are followed EU RoHS directive (No.2002/95/EC).
- ESD pass HBM 8000V/MM2000V
- MSL class1

### 1.2 Applications

- Power Supply regulators
- Digital logic inputs
- Microprocessor inputs
- Appliance Sensor Systems
- Industrial Controls

## Photocoupler CNY17F series

### 2. PACKAGE DIMENSIONS

#### 2.1 CNY17F-1, CNY17F-2, CNY17F-3, CNY17F-4

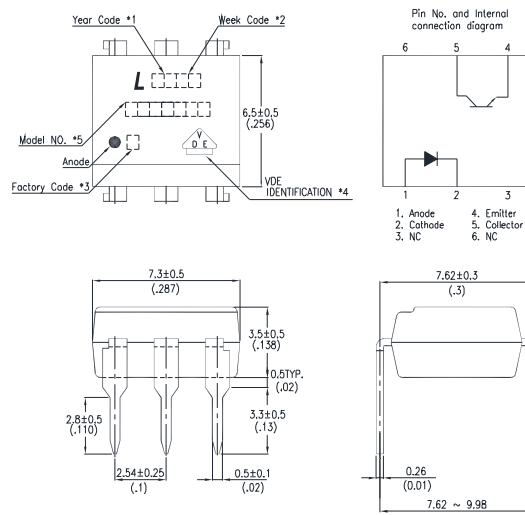

#### 2.2 CNY17F-1M, CNY17F-2M, CNY17F-3M, CNY17F-4M

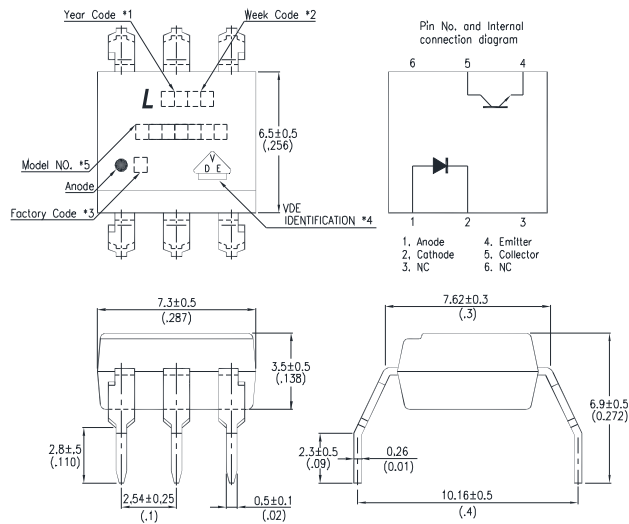

Notes :

Part No : CNY17F series  
BNS-OD-FC002/A4  
Rev. : C

### Photocoupler CNY17F series

1. Year date code.
2. 2-digit work week.
3. Factory identification mark shall be marked (Y: Thailand, W: China-CZ).
4. VDE option.
5. Model No.: CNY17F-1, CNY17F-2, CNY17F-3, CNY17F-4

\* All dimensions in millimeters.

## Photocoupler CNY17F series

### 2.3 CNY17F-1S, CNY17F-2S, CNY17F-3S, CNY17F-4S

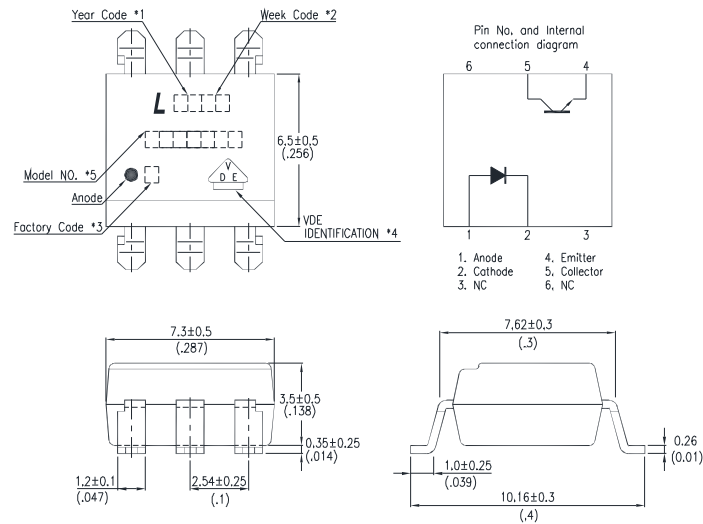

#### Notes :

1. Year date code.
2. 2-digit work week.
3. Factory identification mark shall be marked (Y: Thailand, W: China-CZ).
4. VDE option.
5. Model No.: CNY17F-1, CNY17F-2, CNY17F-3, CNY17F-4

\* All dimensions in millimeters.

## Photocoupler CNY17F series

### 3. TAPING DIMENSIONS

#### 3.1 CNY17F-1S-TA, CNY17F-2S-TA, CNY17F-3S-TA, CNY17F-4S-TA

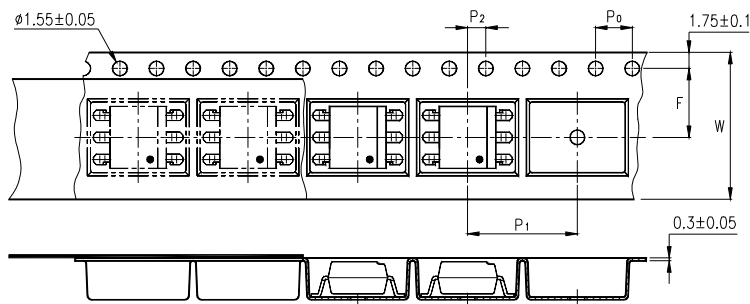

#### 3.2 CNY17F-1S-TA1, CNY17F-2S-TA1, CNY17F-3S-TA1, CNY17F-4S-TA1

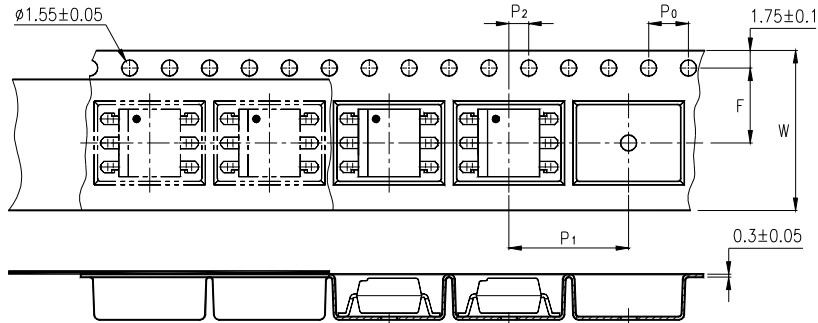

| Description                            | Symbol         | Dimension in mm<br>(inch) |
|--|----------------|---------------------------|
| Tape wide                              | W              | 16±0.3 (0.63)             |
| Pitch of sprocket holes                | P <sub>0</sub> | 4±0.1 (0.15)              |
| Distance of compartment                | F              | 7.5±0.1 (0.295)           |
|  | P <sub>2</sub> | 2±0.1 (0.079)             |
| Distance of compartment to compartment | P <sub>1</sub> | 12±0.1 (0.472)            |

| Package Type     | CNY17F series |
|------------------|---------------|
| Quantities (pcs) | 1000          |

Part No : CNY17F series  
BNS-OD-FC002/A4  
Rev.: C

## Photocoupler CNY17F series

### 3.3 Quantities Per Reel

| Package Type     | CNY17F series |
|------------------|---------------|
| Quantities (pcs) | 1000          |

## 4. RATING AND CHARACTERISTICS

### 4.1 Absolute Maximum Ratings at Ta=25°C

| Parameter                |                             | Symbol    | Rating     | Unit      |
|--------------------------|-----------------------------|-----------|------------|-----------|
| Input                    | Forward Current             | $I_F$     | 60         | mA        |
|                          | Reverse Voltage             | $V_R$     | 6          | V         |
|                          | Power Dissipation           | $P$       | 100        | mW        |
| Output                   | Collector - Emitter Voltage | $V_{CEO}$ | 70         | V         |
|                          | Emitter - Collector Voltage | $V_{ECO}$ | 7          | V         |
|                          | Collector Current           | $I_C$     | 150        | mA        |
|                          | Collector Power Dissipation | $P_C$     | 150        | mW        |
| Total Power Dissipation  |                             | $P_{tot}$ | 250        | mW        |
| *1 Isolation Voltage     |                             | $V_{iso}$ | 5000       | $V_{rms}$ |
| Operating Temperature    |                             | $T_{opr}$ | -55 ~ +100 | °C        |
| Storage Temperature      |                             | $T_{stg}$ | -55 ~ +150 | °C        |
| *2 Soldering Temperature |                             | $T_{sol}$ | 260        | °C        |

\*1. AC For 1 Minute, R.H. = 40 ~ 60%

Isolation voltage shall be measured using the following method.

- (1) Short between anode and cathode on the primary side and between collector and emitter on the secondary side.
- (2) The isolation voltage tester with zero-cross circuit shall be used.
- (3) The waveform of applied voltage shall be a sine wave.

\*2. For 10 Seconds



## Photocoupler CNY17F series

### 4.2 ELECTRICAL OPTICAL CHARACTERISTICS at Ta=25°C

| PARAMETER                |                                      | SYMBOL   | MIN. | TYP. | MAX. | UNIT | CONDITIONS              |                   |
|--------------------------|--------------------------------------|----------|------|------|------|------|-------------------------|-------------------|
| INPUT                    | Forward Voltage                      | VF       | —    | 1.45 | 1.65 | V    | IF=60mA                 |                   |
|                          | Reverse Current                      | IR       | —    | —    | 10   | μA   | VR=6V                   |                   |
|                          | Terminal Capacitance                 | Ct       | —    | —    | 100  | pF   | V=0, f=1KHz             |                   |
| OUTPUT                   | Collector Dark Current               | ICEO     | —    | —    | 50   | nA   | VCE=10V, IF=0           |                   |
|                          | Collector-Emitter Breakdown Voltage  | BVCEO    | 70   | —    | —    | V    | IC=0.1mA<br>IF=0        |                   |
|                          | Emitter-Collector Breakdown Voltage  | BVECO    | 7    | —    | —    | V    | IE=10μA<br>IF=0         |                   |
| TRANSFER CHARACTERISTICS | Current *Transfer Ratio              | CNY17F-1 | CTR  | 40   | —    | 80   | %                       | IF=10mA<br>VCE=5V |
|                          |                                      | CNY17F-2 |      | 63   | —    | 125  |                         |                   |
|                          |                                      | CNY17F-3 |      | 100  | —    | 200  |                         |                   |
|                          |                                      | CNY17F-4 |      | 160  | —    | 320  |                         |                   |
|                          | Collector-Emitter Saturation Voltage | VCE(sat) | —    | —    | 0.3  | V    | IF=10mA<br>IC=2.5mA     |                   |
|                          | Isolation Resistance                 | Riso     | 100  | —    | —    | GΩ   | DC500V<br>40 ~ 60% R.H. |                   |
|                          | Floating Capacitance                 | Cf       | —    | —    | 2    | pF   | V=0, f=1MHz             |                   |
|                          | Response Time (Rise)                 | tr       | —    | 5    | 10   | μs   | VCE=10V, IC=2mA         |                   |
|                          | Response Time (Fall)                 | tf       | —    | 5    | 10   | μs   | RL=100Ω                 |                   |

$$*CTR = \frac{I_C}{I_F} \times 100\%$$

## Photocoupler CNY17F series

### 4.3 ISOLATION SPECIFICATION ACCORDING TO VDE

| Parameter   | Symbol        | Conditions                     | Rating               | Unit       | Remark                    |
|---|---------------|--------------------------------|----------------------|------------|---------------------------|
| Class of environmental test   | -             | DIN IEC68                      | 55/100/21            | -          |                           |
| Pollution   | -             | DIN VDE0110                    | 2                    | -          |                           |
| Maximum Operating Isolation Voltage                                   | $V_{IORM}$    | -                              | 850                  | $V_{PEAK}$ |                           |
| Partial Discharge Test Voltage (Between Input and Output)             | Diagram 1     | $t_p=60s, q_c<5pC$             | 1275                 | $V_{PEAK}$ | Refer to the Diagram 1, 2 |
|   | Diagram 2     | $t_p=1s, q_c<5pC$              | 1594                 | $V_{PEAK}$ |                           |
| Maximum Over-voltage  | $V_{INITIAL}$ | $t_{INI} = 10s$                | 6000                 | $V_{PEAK}$ |                           |
| Safety Maximum Ratings  |               |                                |                      |            |                           |
| 1) Case Temperature   | $T_{si}$      | $I_F = 0, P_c = 0$             | 175                  | °C         | Refer to the Figure 1, 3  |
| 2) Input Current  | $I_{si}$      | $P_c=0$                        | 400                  | mA         |                           |
| 3) Electric Power (Output or Total Power Issipation)                  | $P_{si}$      | -                              | 700                  | mW         |                           |
| Isolation Resistance (Test Voltage Between Input and Output : DC500V) | $R_{ISO}$     | $T_a=T_{si}$                   | MIN.10 <sup>9</sup>  | $\Omega$   |                           |
|   |               | $T_a=T_{opr}(MAX.)$            | MIN.10 <sup>11</sup> |            |                           |
|   |               | $T_a=25\text{ }^\circ\text{C}$ | MIN.10 <sup>12</sup> |            |                           |

#### Precautions in performing isolation test

\* Partial discharge test methods shall be the ones according to the specifications of DIN EN 60747-5-5

\* Please don't carry out isolation test (Viso) over  $V_{INITIAL}$  ,This product deteriorates isolation characteristics by partial discharge due to applying high voltage

## Photocoupler CNY17F series

(ex.  $V_{INITIAL}$ ). And there is possibility that this product occurs partial discharge in operating isolation voltage ( $V_{IORM}$ )

### 4.4 PARTIAL DISCHARGE TEST METHOD

Method (A) for type testing and random testing.

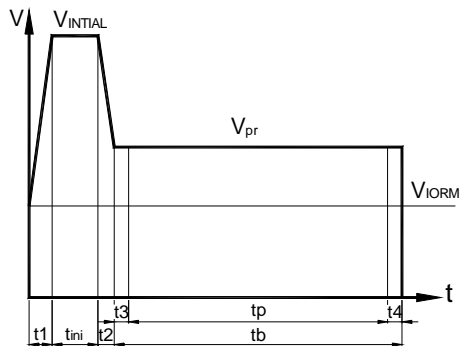

$t1, t2$  = 1 to 10s  
 $t3, t4$  = 1s  
 $t_p$  (Partial Discharge Measuring Time) = 60s  
 $t_b$  = 62s  
 $t_{ini}$  = 10s

Method (B) for routine testing.

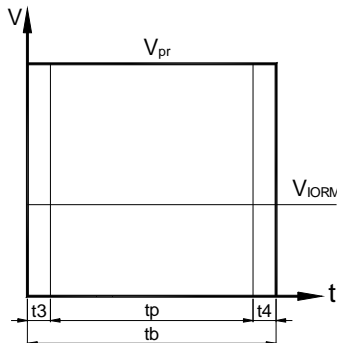

$t3, t4$  = 0.1s  
 $t_p$  (Partial Discharge Measuring Time) = 1s  
 $t_b$  = 1.2s

The partial discharge level shall not exceed 5 pc during the partial discharge measuring time interval  $t_p$  under the test conditions shown above.

### 5. CHARACTERISTICS CURVES

Fig.1 Forward Current vs. Ambient Temperature

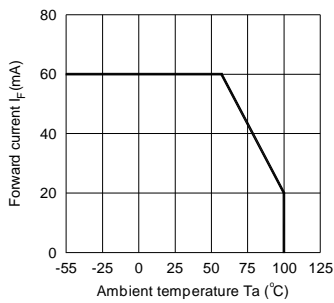

Fig.2 Collector Power Dissipation vs. Ambient Temperature

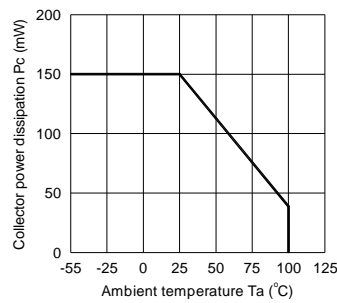

Fig.3 Collector-emitter Saturation Voltage vs. Forward Current

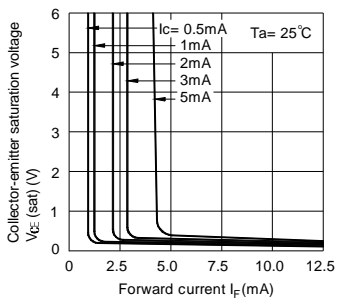

Fig.4 Forward Current vs. Forward Voltage

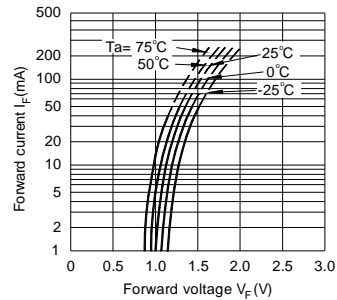

Fig.5 Current Transfer Ratio vs. Forward Current

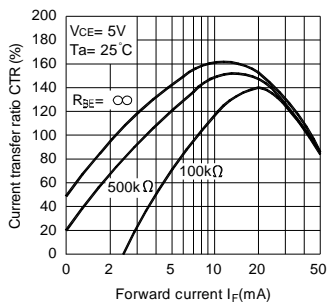
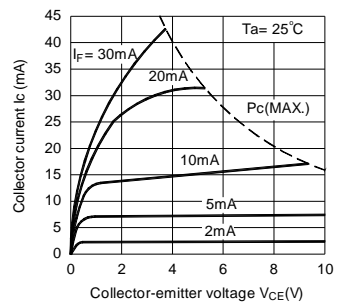

Fig.6 Collector Current vs. Collector-emitter Voltage



## Photocoupler CNY17F series

Fig.7 Relative Current Transfer Ratio vs. Ambient Temperature

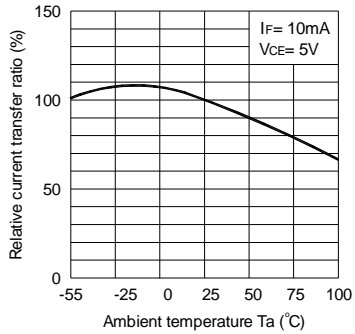

Fig.8 Collector-emitter Saturation Voltage vs. Ambient Temperature

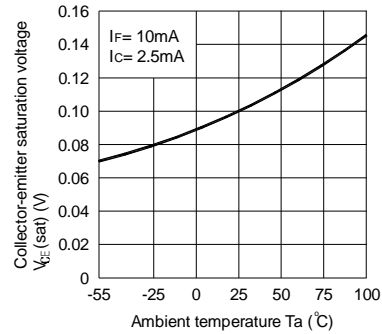

Fig.9 Collector Dark Current vs. Ambient Temperature

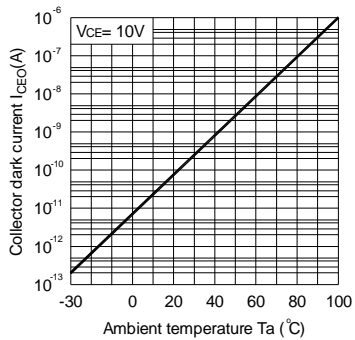

Fig.10 Response Time vs. Load Resistance

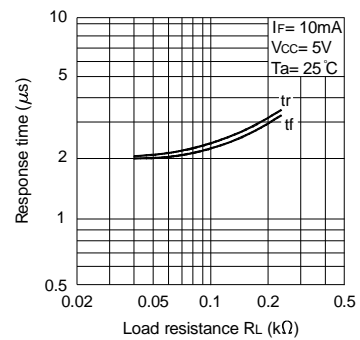
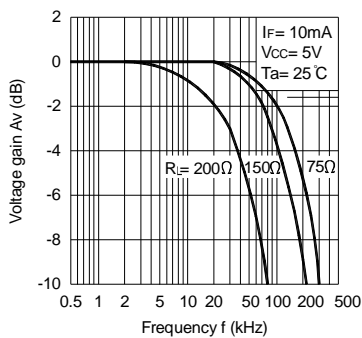
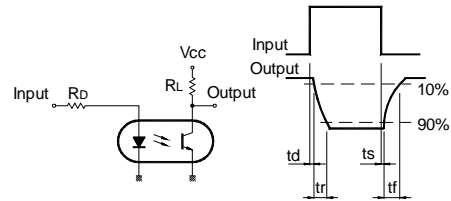

Fig.11 Frequency Response



Test Circuit for Response Time



Test Circuit for Frequency Response

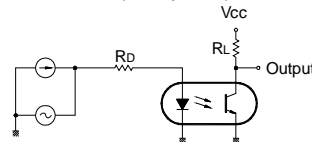

## Photocoupler CNY17F series

### 6. TEMPERATURE PROFILE OF SOLDERING

#### 6.1 IR Reflow soldering (JEDEC-STD-020C compliant)

One time soldering reflow is recommended within the condition of temperature and time profile shown below. Do not solder more than three times.

| Profile item                     | Conditions     |
|----------------------------------|----------------|
| Preheat                          |                |
| - Temperature Min ( $T_{Smin}$ ) | 150°C          |
| - Temperature Max ( $T_{Smax}$ ) | 200°C          |
| - Time (min to max) (ts)         | 90±30 sec      |
| Soldering zone                   |                |
| - Temperature ( $T_L$ )          | 217°C          |
| - Time ( $t_L$ )                 | 60 sec         |
| Peak Temperature ( $T_P$ )       | 260°C          |
| Ramp-up rate                     | 3°C / sec max. |
| Ramp-down rate                   | 3~6°C / sec    |

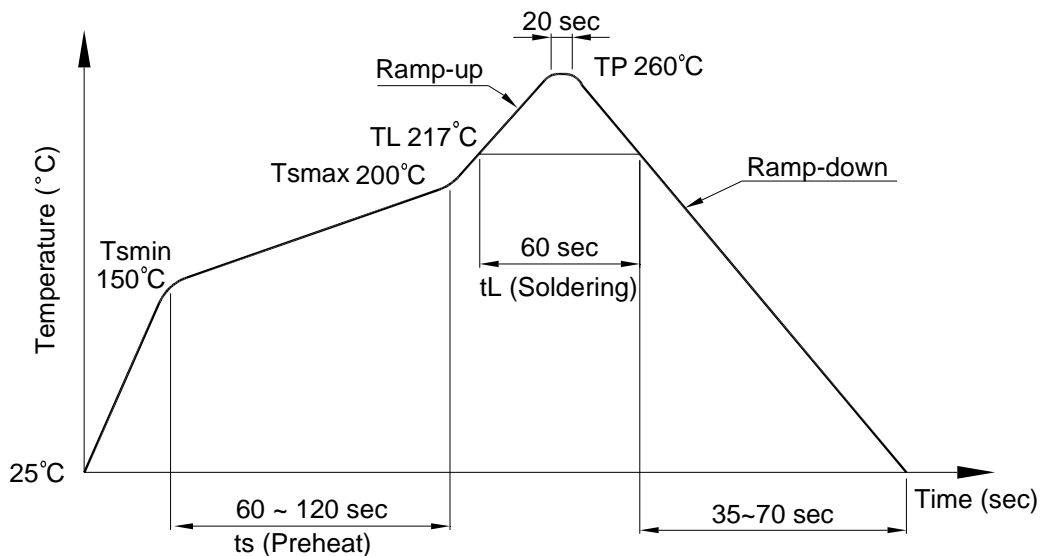

**Photocoupler  
CNY17F series**

**6.2 Wave soldering (JEDEC22A111 compliant)**

One time soldering is recommended within the condition of temperature.

Temperature:  $260 \pm 0 / -5^{\circ}\text{C}$

Time: 10 sec.

Preheat temperature: 25 to  $140^{\circ}\text{C}$

Preheat time: 30 to 80 sec.

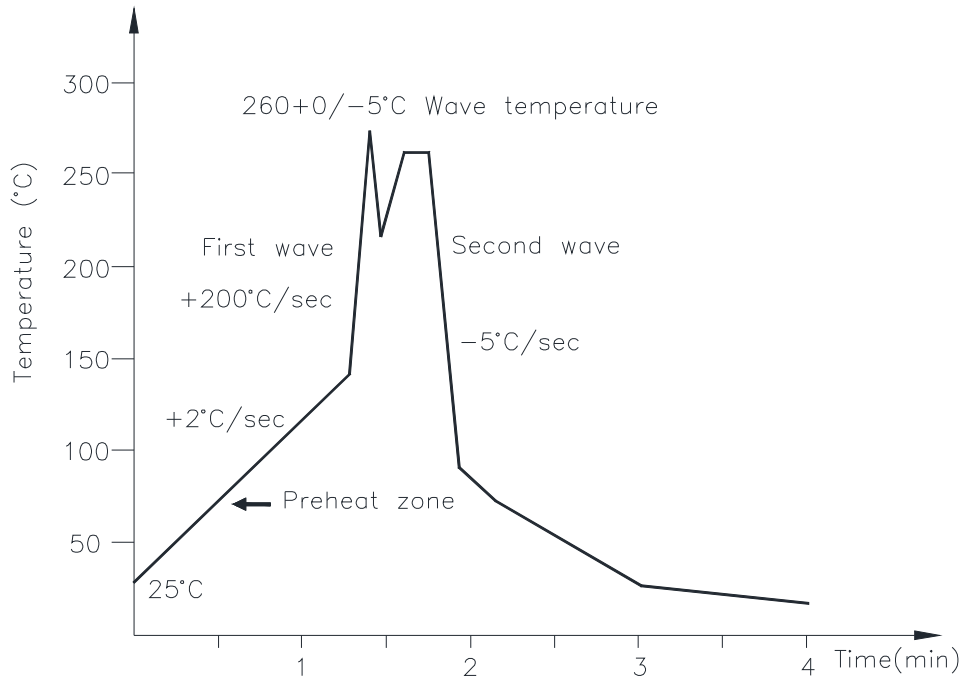

**6.3 Hand soldering by soldering iron**

Allow single lead soldering in every single process. One time soldering is recommended.

Temperature:  $380 \pm 0 / -5^{\circ}\text{C}$

Time: 3 sec max.

**Photocoupler  
CNY17F series**

**7. RRECOMMENDED FOOT PRINT PATTERNS (MOUNT PAD)**

Unit: mm

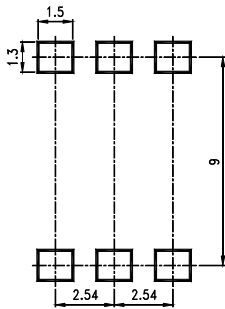

**8. NAMING RULE**

**CNY17F-X(1)-(2)**

DEVICE PART NUMBER

Classified by CTR RANK

Please refer to the CTR table on Page P7

(1) No suffix = Dual-in-Line package

M = Wide lead spacing package

S = Surface mounting package

(2) TAPING TYPE (TA, TA1 or none)

Please refer to orientation of taping on Page P5

Example : CNY17F-1S-TA1



## Photocoupler CNY17F series

# CNY17F-X(1)(2)-V

DEVICE PART NUMBER

Classified by CTR RANK

Please refer to the CTR table on Page P7

(1) No suffix = Dual-in-Line package

M = Wide lead spacing package

S = Surface mounting package

(2) TAPING TYPE (TA, TA1 or none)

Please refer to orientation of taping on Page P5

(3) VDE Option

Example : CNY17F-1STA1-V

## 9. NOTES

- LiteOn is continually improving the quality, reliability, function or design and LiteOn reserves the right to make changes without further notices.
- The products shown in this publication are designed for the general use in electronic applications such as office automation equipment, communications devices, audio/visual equipment, electrical application and instrumentation.
- For equipment/devices where high reliability or safety is required, such as space applications, nuclear power control equipment, medical equipment, etc, please contact our sales representatives.
- When requiring a device for any "specific" application, please contact our sales in advice.
- If there are any questions about the contents of this publication, please contact us at your convenience.
- The contents described herein are subject to change without prior notice.
- Immerge unit's body in solder paste is not recommended.

# Mouser Electronics

Authorized Distributor

Click to View Pricing, Inventory, Delivery & Lifecycle Information:

## Lite-On:

[CNY17F-3M](#) [CNY17F-4](#) [CNY17F-2S-TA1](#) [CNY17F-2](#) [CNY17F-1](#) [CNY17F-2M](#) [CNY17F-1M](#) [CNY17F-4S](#) [CNY17F-3S-TA](#) [CNY17F-4S-TA](#) [CNY17F-3S](#) [CNY17F-1S](#) [CNY17F-2S-TA](#) [CNY17F-3S-TA1](#) [CNY17F-4S-TA1](#) [CNY17F-4M](#) [CNY17F-1S-TA1](#) [CNY17F-2S](#) [CNY17F-3](#) [CNY17F-1S-TA](#)

Компания «Life Electronics» занимается поставками электронных компонентов импортного и отечественного производства от производителей и со складов крупных дистрибьюторов Европы, Америки и Азии.

С конца 2013 года компания активно расширяет линейку поставок компонентов по направлению коаксиальный кабель, кварцевые генераторы и конденсаторы (керамические, пленочные, электролитические), за счёт заключения дистрибьюторских договоров

Мы предлагаем:

- Конкурентоспособные цены и скидки постоянным клиентам.
- Специальные условия для постоянных клиентов.
- Подбор аналогов.
- Поставку компонентов в любых объемах, удовлетворяющих вашим потребностям.
- Приемлемые сроки поставки, возможна ускоренная поставка.
- Доставку товара в любую точку России и стран СНГ.
- Комплексную поставку.
- Работу по проектам и поставку образцов.
- Формирование склада под заказчика.
- Сертификаты соответствия на поставляемую продукцию (по желанию клиента).
- Тестирование поставляемой продукции.
- Поставку компонентов, требующих военную и космическую приемку.
- Входной контроль качества.
- Наличие сертификата ISO.

В составе нашей компании организован Конструкторский отдел, призванный помогать разработчикам, и инженерам.

Конструкторский отдел помогает осуществить:

- Регистрацию проекта у производителя компонентов.
- Техническую поддержку проекта.
- Защиту от снятия компонента с производства.
- Оценку стоимости проекта по компонентам.
- Изготовление тестовой платы монтаж и пусконаладочные работы.



Тел: +7 (812) 336 43 04 (многоканальный)

Email: [org@lifeelectronics.ru](mailto:org@lifeelectronics.ru)