

**MG1275W-XBN2MM**

RoHS

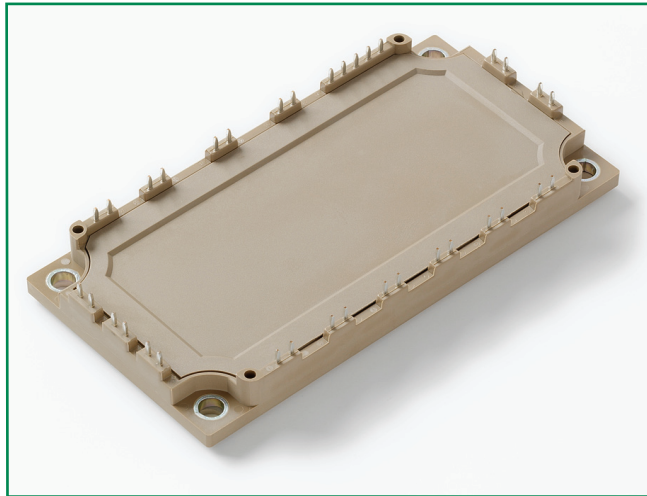

**Features**

- High level of integration—only one power semiconductor module required for the whole drive
- Low saturation voltage and positive temperature coefficient
- Fast switching and short tail current
- Free wheeling diodes with fast and soft reverse recovery
- Industry standard package with insulated copper base plate and soldering pins for PCB mounting
- Temperature sense included

**Applications**

- AC motor control
- Motion/servo control
- Inverter and power supplies

**Module Characteristics ( $T_J = 25^\circ\text{C}$ , unless otherwise specified)**

Symbol	Parameters	Test Conditions	Min	Typ	Max	Unit
$T_{J\text{max}}$	Max. Junction Temperature				150	$^\circ\text{C}$
$T_{J\text{op}}$	Operating Temperature		-40		125	$^\circ\text{C}$
$T_{\text{stg}}$	Storage Temperature		-40		125	$^\circ\text{C}$
$V_{\text{isol}}$	Insulation Test Voltage	AC, t=1min		3000		V
CTI	Comparative Tracking Index		250			
$M_d$	Mounting Torque	Recommended (M5)	2.5		5	N-m
Weight				300		g

**Absolute Maximum Ratings ( $T_J = 25^\circ\text{C}$ , unless otherwise specified)**

Symbol	Parameters	Test Conditions	Values	Unit
<b>IGBT</b>				
$V_{\text{CES}}$	Collector - Emitter Voltage	$T_J=25^\circ\text{C}$	1200	V
$V_{\text{GES}}$	Gate - Emitter Voltage		$\pm 20$	V
$I_C$	DC Collector Current	$T_C=25^\circ\text{C}$	105	A
		$T_C=80^\circ\text{C}$	75	A
$I_{\text{CM}}$	Repetitive Peak Collector Current	$t_p=1\text{ms}$	150	A
$P_{\text{tot}}$	Power Dissipation Per IGBT		348	W
<b>Diode</b>				
$V_{\text{RRM}}$	Repetitive Reverse Voltage	$T_J=25^\circ\text{C}$	1200	V
$I_{\text{F(AV)}}$	Average Forward Current	$T_C=25^\circ\text{C}$	105	A
		$T_C=80^\circ\text{C}$	75	A
$I_{\text{FRM}}$	Repetitive Peak Forward Current	$t_p=1\text{ms}$	150	A
$I^2t$		$T_J=125^\circ\text{C}$ , t=10ms, $V_R=0\text{V}$	1150	$\text{A}^2\text{s}$

### Electrical and Thermal Specifications ( $T_J = 25^\circ\text{C}$ , unless otherwise specified)

Symbol	Parameters	Test Conditions	Min	Typ	Max	Unit
<b>IGBT</b>						
$V_{GE(th)}$	Gate - Emitter Threshold Voltage	$V_{CE}=V_{GE}, I_C=3.0\text{mA}$	5.0	5.8	6.5	V
$V_{CE(sat)}$	Collector - Emitter	$I_C=75\text{A}, V_{GE}=15\text{V}, T_J=25^\circ\text{C}$		1.7		V
	Saturation Voltage	$I_C=75\text{A}, V_{GE}=15\text{V}, T_J=125^\circ\text{C}$		1.9		V
$I_{ICES}$	Collector Leakage Current	$V_{CE}=1200\text{V}, V_{GE}=0\text{V}, T_J=25^\circ\text{C}$			1	mA
		$V_{CE}=1200\text{V}, V_{GE}=0\text{V}, T_J=125^\circ\text{C}$			10	mA
$I_{GES}$	Gate Leakage Current	$V_{CE}=0\text{V}, V_{GE}=\pm 15\text{V}, T_J=125^\circ\text{C}$	-400		400	nA
$R_{Gint}$	Integrated Gate Resistor			10		$\Omega$
$Q_{ge}$	Gate Charge	$V_{CE}=600\text{V}, I_C=75\text{A}, V_{GE}=\pm 15\text{V}$		0.7		$\mu\text{C}$
$C_{ies}$	Input Capacitance	$V_{CE}=25\text{V}, V_{GE}=0\text{V}, f=1\text{MHz}$		5.3		nF
$C_{RES}$	Reverse Transfer Capacitance				0.2	
$t_{d(on)}$	Turn - on Delay Time	$V_{CC}=600\text{V}$ $I_C=75\text{A}$ $R_G=4.7\Omega$ $V_{GE}=\pm 15\text{V}$ Inductive Load	$T_J=25^\circ\text{C}$		260	ns
			$T_J=125^\circ\text{C}$		290	ns
$t_r$	Rise Time		$T_J=25^\circ\text{C}$		30	ns
			$T_J=125^\circ\text{C}$		50	ns
$t_{d(off)}$	Turn - off Delay Time		$T_J=25^\circ\text{C}$		420	ns
			$T_J=125^\circ\text{C}$		520	ns
$t_f$	Fall Time		$T_J=25^\circ\text{C}$		70	ns
			$T_J=125^\circ\text{C}$		90	ns
$E_{on}$	Turn - on Energy		$T_J=25^\circ\text{C}$		6.6	mJ
			$T_J=125^\circ\text{C}$		9.4	mJ
$E_{off}$	Turn - off Energy	$T_J=25^\circ\text{C}$		6.8	mJ	
		$T_J=125^\circ\text{C}$		8.0	mJ	
$I_{SC}$	Short Circuit Current	$t_{psc} \leq 10\mu\text{s}, V_{GE}=15\text{V}, T_J=125^\circ\text{C}, V_{CC}=900\text{V}$		300		A
$R_{thJC}$	Junction-to-Case Thermal Resistance (Per IGBT)				0.36	K/W
<b>Diode</b>						
$V_F$	Forward Voltage	$I_F=75\text{A}, V_{GE}=0\text{V}, T_J=25^\circ\text{C}$		1.65		V
		$I_F=75\text{A}, V_{GE}=0\text{V}, T_J=125^\circ\text{C}$		1.65		V
$t_{RR}$	Reverse Recovery Time	$I_F=75\text{A}, V_R=600\text{V}$ $di_p/dt=2000\text{A}/\mu\text{s}$ $T_J=125^\circ\text{C}$		300		ns
$I_{RRM}$	Max. Reverse Recovery Current			85		A
$E_{rec}$	Reverse Recovery Energy			6.5		mJ
$R_{thJCD}$	Junction-to-Case Thermal Resistance (Per Diode)				0.6	K/W

### Diode-Rectifier Absolute Maximum Ratings ( $T_J = 25^\circ\text{C}$ , unless otherwise specified)

Symbol	Parameters	Test Conditions	Values	Unit
$V_{RRM}$	Repetitive Reverse Voltage	$T_J=25^\circ\text{C}$	1600	V
$I_{F(AV)}$	Average Forward Current	$T_C=80^\circ\text{C}$	75	A
$I_{FRM}$	Non-Repetitive Surge Forward Current	$T_J=45^\circ\text{C}$ , $t=10\text{ms}$ , 50Hz	450	A
		$T_J=45^\circ\text{C}$ , $t=8.3\text{ms}$ , 60Hz	400	
$I^2t$		$T_J=45^\circ\text{C}$ , $t=10\text{ms}$ , 50Hz	1012	A <sup>2</sup> s
		$T_J=45^\circ\text{C}$ , $t=8.3\text{ms}$ , 60Hz	800	

### Diode-Rectifier Electrical and Thermal Specifications ( $T_J = 25^\circ\text{C}$ , unless otherwise specified)

Symbol	Parameters	Test Conditions	Min	Typ	Max	Unit
$V_F$	Forward Voltage	$I_F=75\text{A}$ , $T_J=25^\circ\text{C}$		1.25		V
		$I_F=75\text{A}$ , $T_J=125^\circ\text{C}$		1.15		V
$I_R$	Reverse Leakage Current	$V_R=1600\text{V}$ , $T_J=25^\circ\text{C}$			50	$\mu\text{A}$
		$V_R=1600\text{V}$ , $T_J=125^\circ\text{C}$			1	mA
$R_{thJCD}$	Junction-to-Case Thermal Resistance (Per Diode)				0.66	K/W

### Brake-Chopper Absolute Maximum Ratings ( $T_J = 25^\circ\text{C}$ , unless otherwise specified)

Symbol	Parameters	Test Conditions	Values	Unit
<b>IGBT</b>				
$V_{CES}$	Collector - Emitter Voltage	$T_J=25^\circ\text{C}$	1200	V
$V_{GES}$	Gate - Emitter Voltage		$\pm 20$	V
$I_C$	DC Collector Current	$T_C=25^\circ\text{C}$	55	A
		$T_C=80^\circ\text{C}$	40	A
$I_{CM}$	Repetitive Peak Collector Current	$t_p=1\text{ms}$	80	A
$P_{tot}$	Power Dissipation Per IGBT		195	W
<b>Diode</b>				
$V_{RRM}$	Repetitive Reverse Voltage	$T_J=25^\circ\text{C}$	1200	V
$I_{F(AV)}$	Average Forward Current	$T_C=25^\circ\text{C}$	35	A
		$T_C=80^\circ\text{C}$	25	A
$I_{FRM}$	Repetitive Peak Forward Current	$t_p=1\text{ms}$	50	A
$I^2t$		$T_J=125^\circ\text{C}$ , $t=10\text{ms}$ , $V_R=0\text{V}$	200	A <sup>2</sup> s

### Brake-Chopper Electrical and Thermal Characteristics ( $T_J = 25^\circ\text{C}$ , unless otherwise specified)

Symbol	Parameters	Test Conditions	Min	Typ	Max	Unit
<b>IGBT</b>						
$V_{GE(th)}$	Gate - Emitter Threshold Voltage	$V_{CE}=V_{GE}, I_C=1.5\text{mA}$	5.0	5.8	6.5	V
$V_{CE(sat)}$	Collector - Emitter	$I_C=40\text{A}, V_{GE}=15\text{V}, T_J=25^\circ\text{C}$		1.8		V
	Saturation Voltage	$I_C=40\text{A}, V_{GE}=15\text{V}, T_J=125^\circ\text{C}$		2.05		V
$I_{ICES}$	Collector Leakage Current	$V_{CE}=1200\text{V}, V_{GE}=0\text{V}, T_J=25^\circ\text{C}$			0.25	$\mu\text{A}$
		$V_{CE}=1200\text{V}, V_{GE}=0\text{V}, T_J=125^\circ\text{C}$			2	mA
$I_{GES}$	Gate Leakage Current	$V_{CE}=0\text{V}, V_{GE}=\pm 15\text{V}, T_J=125^\circ\text{C}$	-400		400	nA
$R_{Gint}$	Integrated Gate Resistor			6		$\Omega$
$Q_{ge}$	Gate Charge	$V_{CE}=600\text{V}, I_C=40\text{A}, V_{GE}=\pm 15\text{V}$		0.33		$\mu\text{C}$
$C_{ies}$	Input Capacitance	$V_{CE}=25\text{V}, V_{GE}=0\text{V}, f=1\text{MHz}$		2.5		nF
$C_{RES}$	Reverse Transfer Capacitance			0.11		nF
$t_{d(on)}$	Turn - on Delay Time	$V_{CC}=600\text{V}$ $I_C=40\text{A}$ $R_G=27\Omega$ $V_{GE}=\pm 15\text{V}$ Inductive Load	$T_J=25^\circ\text{C}$	90		ns
			$T_J=125^\circ\text{C}$	90		ns
$t_r$	Rise Time		$T_J=25^\circ\text{C}$	30		ns
			$T_J=125^\circ\text{C}$	50		ns
$t_{d(off)}$	Turn - off Delay Time		$T_J=25^\circ\text{C}$	420		ns
			$T_J=125^\circ\text{C}$	520		ns
$t_f$	Fall Time		$T_J=25^\circ\text{C}$	70		ns
			$T_J=125^\circ\text{C}$	90		ns
$E_{on}$	Turn - on Energy		$T_J=25^\circ\text{C}$	4.1		mJ
			$T_J=125^\circ\text{C}$	6.0		mJ
$E_{off}$	Turn - off Energy		$T_J=25^\circ\text{C}$	3.1		mJ
			$T_J=125^\circ\text{C}$	3.6		mJ
$I_{SC}$	Short Circuit Current	$t_{psc}\leq 10\mu\text{s}, V_{GE}=15\text{V}, T_J=125^\circ\text{C}, V_{CC}=900\text{V}$		160		A
$R_{thJC}$	Junction-to-Case Thermal Resistance (Per IGBT)				0.62	K/W
<b>Diode</b>						
$V_F$	Forward Voltage	$I_F=25\text{A}, V_{GE}=0\text{V}, T_J=25^\circ\text{C}$		1.55		V
		$I_F=25\text{A}, V_{GE}=0\text{V}, T_J=125^\circ\text{C}$		1.54		V
$t_{RR}$	Reverse Recovery Time	$I_F=25\text{A}, V_R=600\text{V}$ $di_r/dt=-400\text{A}/\mu\text{s}$ $T_J=125^\circ\text{C}$		200		ns
$I_{RRM}$	Max. Reverse Recovery Current			20		A
$E_{rec}$	Reverse Recovery Energy			1.5		mJ
$R_{thJD}$	Junction-to-Case Thermal Resistance (Per Diode)					1.22

### NTC Characteristics ( $T_J = 25^\circ\text{C}$ , unless otherwise specified)

Symbol	Parameters	Test Conditions	Min	Typ	Max	Unit
$R_{25}$	Resistance	$T_c=25^\circ\text{C}$		5		K $\Omega$
$B_{25/50}$				3375		K

**Figure 1: Typical Output Characteristics for IGBT Inverter**

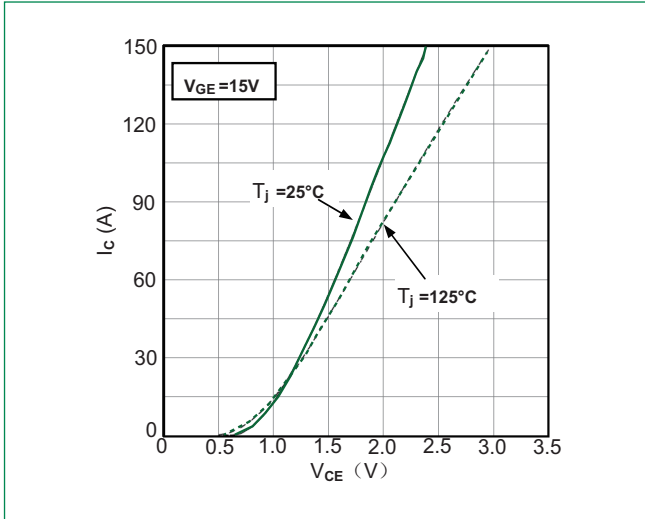

**Figure 2: Typical Output Characteristics for IGBT Inverter**

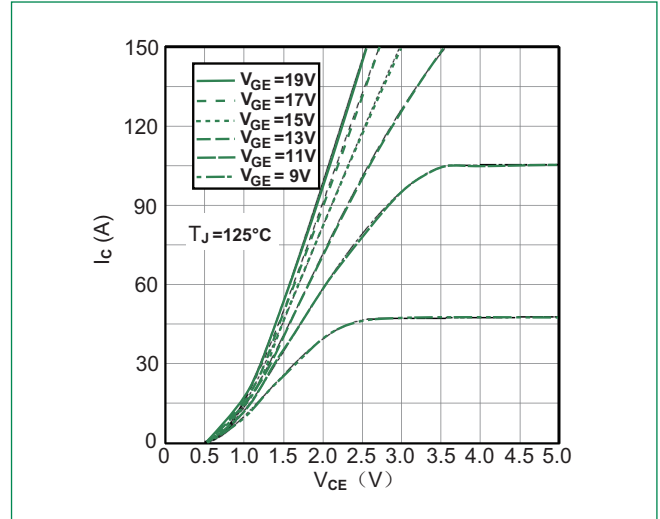

**Figure 3: Typical Transfer Characteristics for IGBT Inverter**

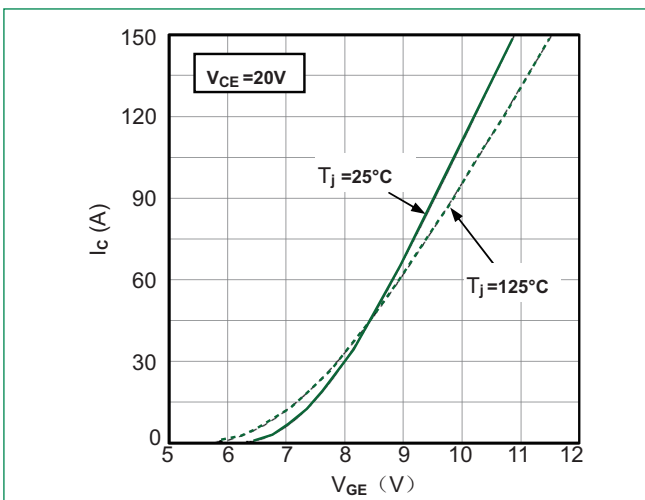

**Figure 4: Switching Energy vs. Gate Resistor for IGBT Inverter**

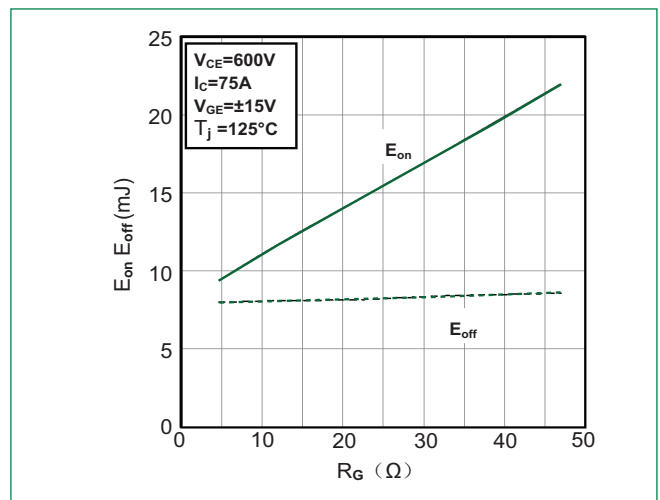

**Figure 5: Switching Energy vs. Collector Current for IGBT Inverter**

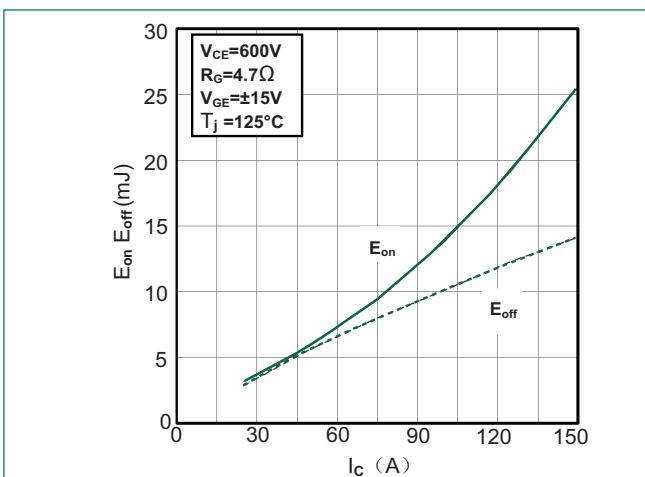

**Figure 6: Reverse Biased Safe Operating Area for IGBT Inverter**

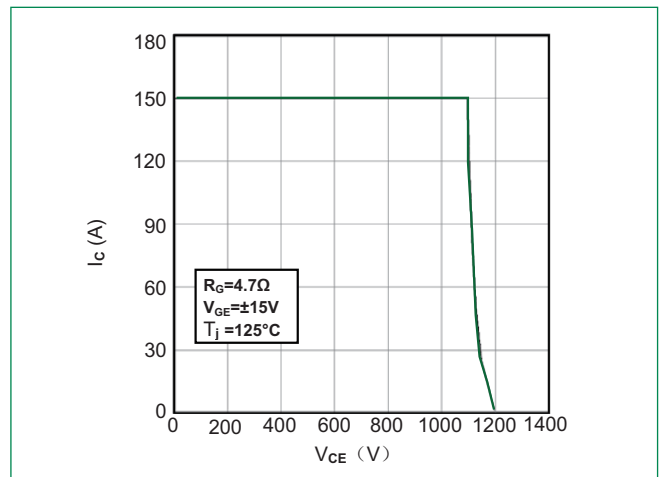

**Figure 7: Diode Forward Characteristics for Diode Inverter**

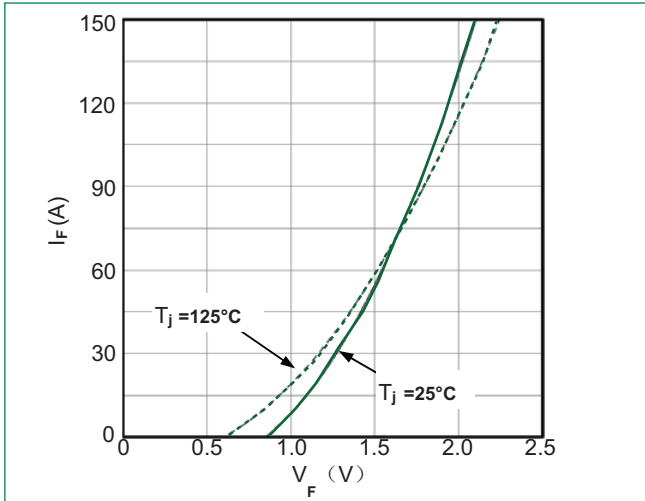

**Figure 8: Switching Energy vs. Gate Resistort for Diode Inverter**

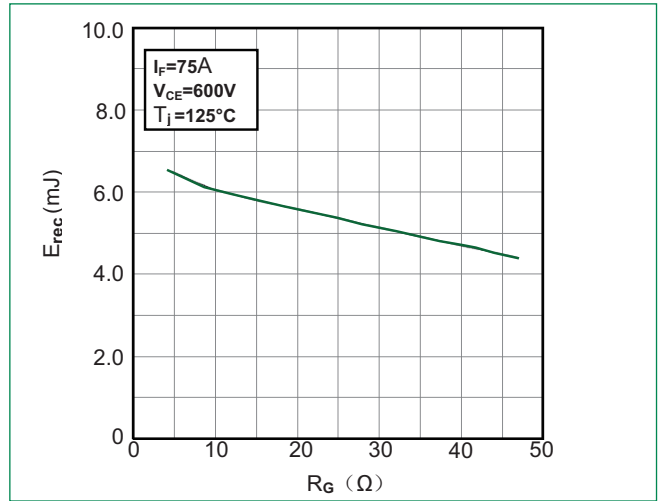

**Figure 9: Switching Energy vs. Forward Current for Diode Inverter**

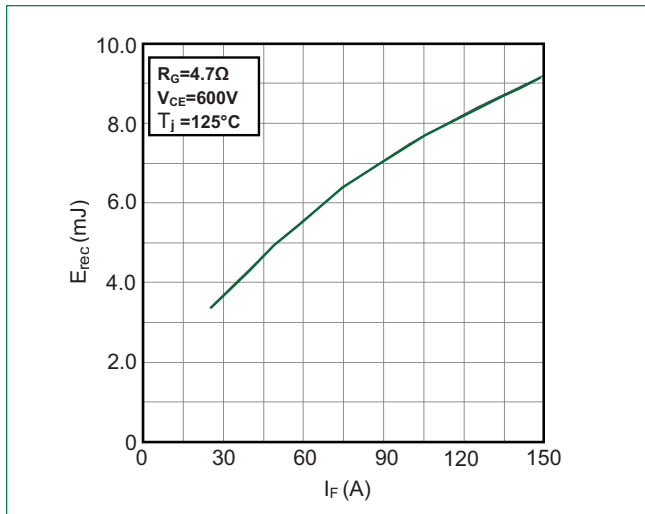

**Figure 10: Transient Thermal Impedance of Diode and IGBT Inverter**

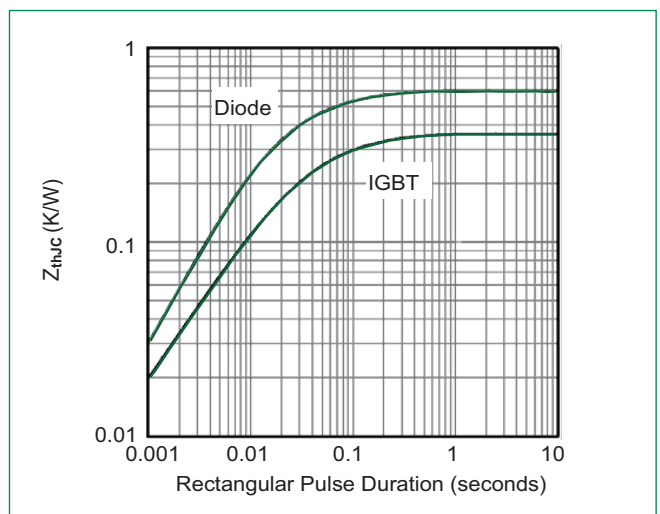

**Figure 11: Diode Forward Characteristics for IGBT Inverter**

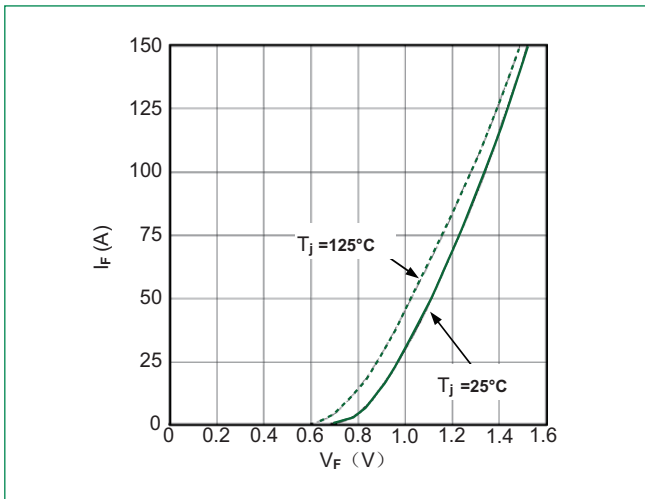

**Figure 12: Typical Output Characteristics for IGBT Brake Chopper**

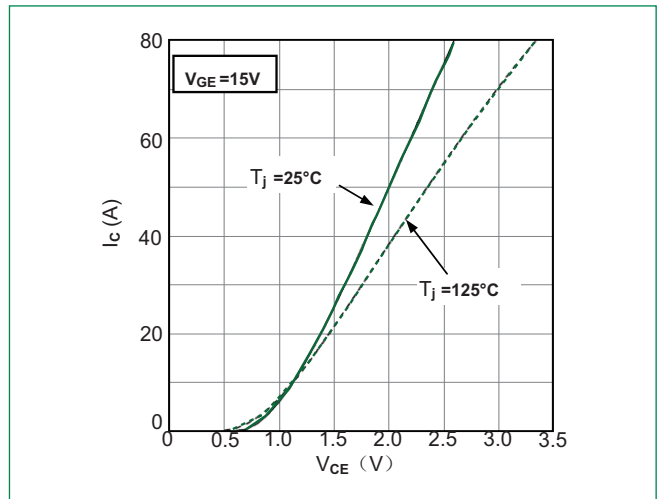

**Figure 13: Diode Forward Characteristics for Diode Brake Chopper**

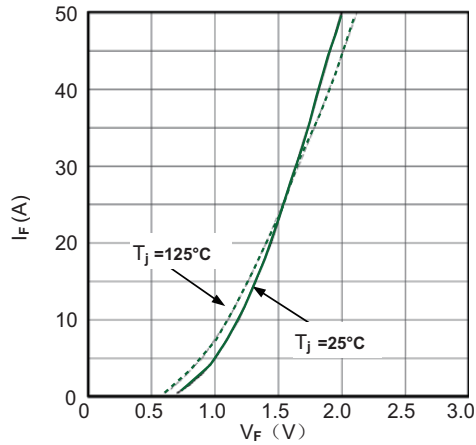

**Figure 14: NTC Characteristics**

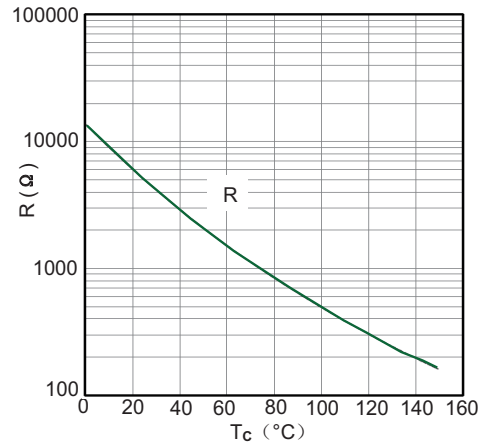

## Circuit Diagram

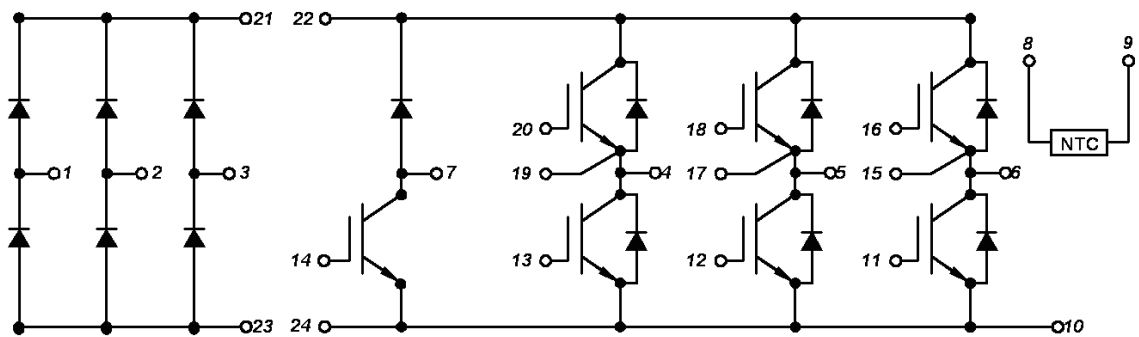

## Part Numbering System

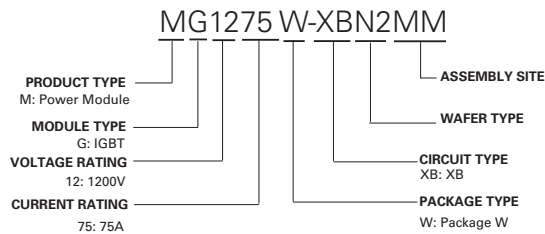

## Part Marking System

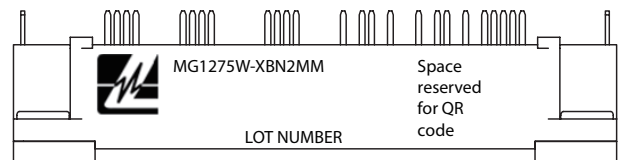

## Packing Options

Part Number	Marking	Weight	Packing Mode	M.O.Q
MG1275W-XBN2MM	MG1275W-XBN2MM	300g	Bulk Pack	20

## Dimensions-Package W

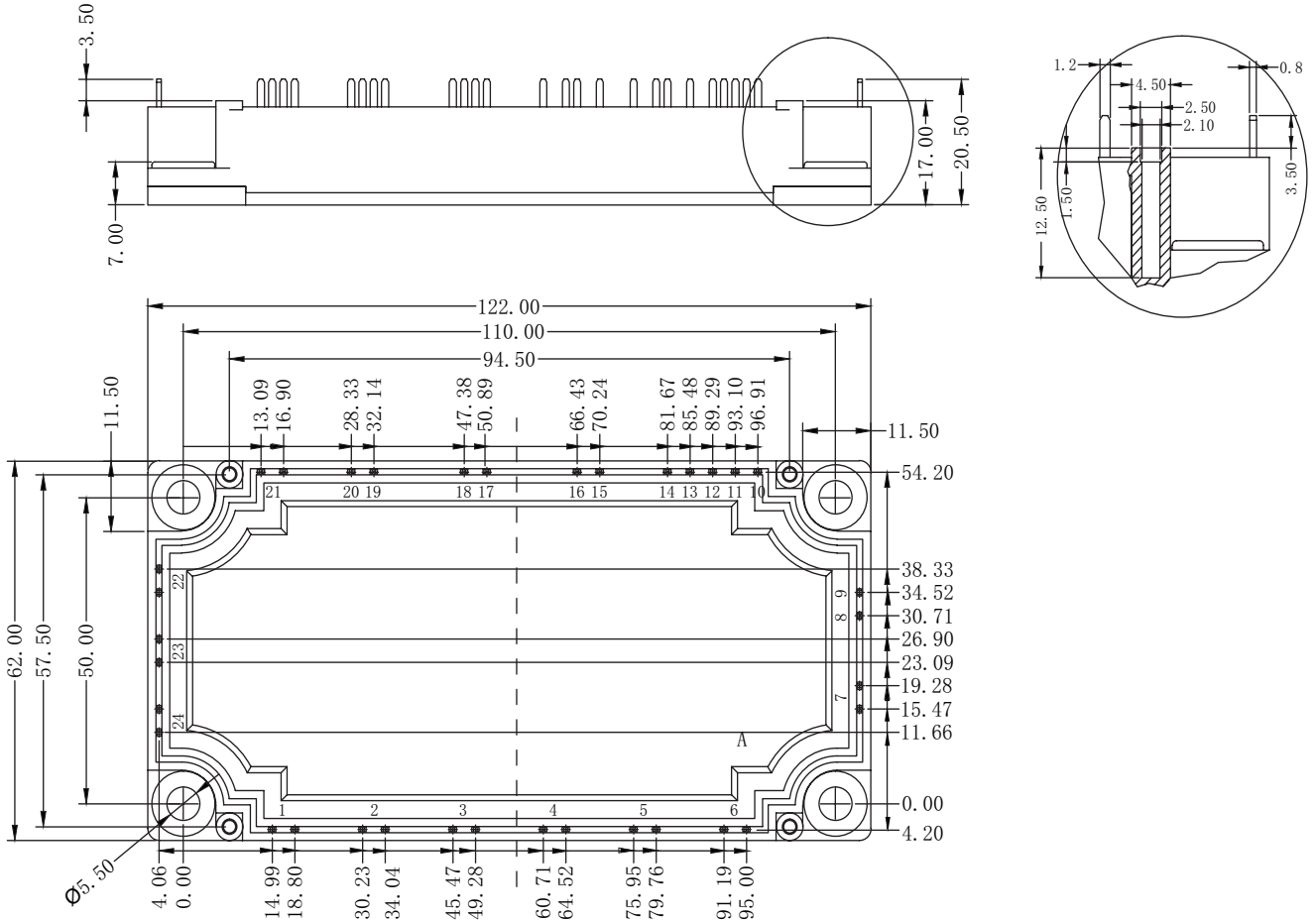

Dimensions (mm)

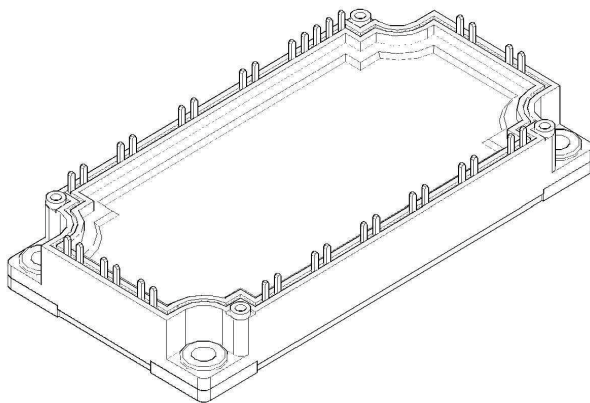



Компания «Life Electronics» занимается поставками электронных компонентов импортного и отечественного производства от производителей и со складов крупных дистрибьюторов Европы, Америки и Азии.

С конца 2013 года компания активно расширяет линейку поставок компонентов по направлению коаксиальный кабель, кварцевые генераторы и конденсаторы (керамические, пленочные, электролитические), за счёт заключения дистрибьюторских договоров

Мы предлагаем:

- Конкурентоспособные цены и скидки постоянным клиентам.
- Специальные условия для постоянных клиентов.
- Подбор аналогов.
- Поставку компонентов в любых объемах, удовлетворяющих вашим потребностям.
- Приемлемые сроки поставки, возможна ускоренная поставка.
- Доставку товара в любую точку России и стран СНГ.
- Комплексную поставку.
- Работу по проектам и поставку образцов.
- Формирование склада под заказчика.
- Сертификаты соответствия на поставляемую продукцию (по желанию клиента).
- Тестирование поставляемой продукции.
- Поставку компонентов, требующих военную и космическую приемку.
- Входной контроль качества.
- Наличие сертификата ISO.

В составе нашей компании организован Конструкторский отдел, призванный помогать разработчикам, и инженерам.

Конструкторский отдел помогает осуществить:

- Регистрацию проекта у производителя компонентов.
- Техническую поддержку проекта.
- Защиту от снятия компонента с производства.
- Оценку стоимости проекта по компонентам.
- Изготовление тестовой платы монтаж и пусконаладочные работы.



Тел: +7 (812) 336 43 04 (многоканальный)

Email: [org@lifeelectronics.ru](mailto:org@lifeelectronics.ru)