

# R15

## Industrial Electromagnetic Relays



- Contacts AgNi
- For plug-in sockets, 35 mm rail mount or on panel mounting.
- Cadmium-free contacts-R15 DPDT, R15 3PDT, R15 4PDT relays
- WT (mechanical indicator and lockable front test button) - standard features of R15 DPDT, R15 3PDT relays in cover, for plug-in sockets.
- Relays may be provided with the test buttons (no latching) and plugs (see page 115).
- AUCOTEAM, GmbH Berlin - railway standards.



### Contact Data

| Number and type of contacts       |      | DPDT  | 3PDT  | 4PDT  |
|-----------------------------------|------|---|---|---|
| Contact material                  |      | AgNi  | AgNi  | AgCdO   |
| Rated / max. switching voltage AC |      | 250 V / 440 V   | 250 V / 440 V   | 250 V / 440 V   |
| Min. switching voltage            |      | 10 V  | 10 V  | 10 V  |
| Rated load (capacity)             | AC1  | 10 A / 250 V AC; 10 A / 277 V AC UL 508                 | 10 A / 250 V AC; 10 A / 277 V AC UL 508                 | 10 A / 250 V AC; 10 A / 277 V AC UL 508                 |
|                                   | AC15 | 3 A / 120 V; 1.5 A / 240 V (B300)                       | 3 A / 120 V; 1.5 A / 240 V (B300)                       | 3 A / 120 V; 1.5 A / 240 V (B300)                       |
|                                   | AC3  | 370 W (single-phase motor.<br>1/2 HP / 240 V AC UL 508) | 370 W (single-phase motor.<br>1/2 HP / 240 V AC UL 508) | 370 W (single-phase motor.<br>1/2 HP / 240 V AC UL 508) |
|                                   | DC1  | 10 A / 24 V DC (see Fig. 3)                             | 10 A / 24 V DC (see Fig. 3)                             | 10 A / 24 V DC (see Fig. 3)                             |
|                                   | DC13 | 0.22 A / 120 V; 0.1 A / 250 V (R300)                    | 0.22 A / 120 V; 0.1 A / 250 V (R300)                    | 0.22 A / 120 V; 0.1 A / 250 V (R300)                    |
| Min. switching current            |      | 5 mA  | 5 mA  | 10 mA   |
| Max. inrush current               |      | 20 A  | 20 A  | 20 A  |
| <b>Rated current</b>              |      | <b>10A</b>  | <b>10A</b>  | <b>10A</b>  |
| Max. breaking capacity            | AC1  | 2500 VA   | 2500 VA   | 2500 VA   |
| Min. breaking capacity            |      | 0.3 W   | 0.3 W   | 0.5 W   |
| Contact resistance                |      | ≤ 100 mΩ  | ≤ 100 mΩ  | ≤ 100 mΩ  |
| Max. operating frequency          |      |   |   |   |
| • at rated load                   |      | AC1 1200 cycles/hour                                    | 1200 cycles/hour  | 1200 cycles/hour  |
| • no load                         |      | 12000 cycles/hour                                       | 12000 cycles/hour                                       | 12000 cycles/hour                                       |

### Coil Data

|                                   |             |  |  |  |
|-----------------------------------|-------------|--|--|--|
| Rated voltage                     | 50/60 Hz AC | 6 ... 240 V  | 6 ... 240 V  | 6 ... 240 V  |
|                                   | DC          | 6 ... 220 V  | 6 ... 220 V  | 6 ... 220 V  |
| Must release voltage              |             | AC: ≥ 0.15 U <sub>n</sub> ; DC: ≥ 0.1 U <sub>n</sub> | AC: ≥ 0.15 U <sub>n</sub> ; DC: ≥ 0.1 U <sub>n</sub> | AC: ≥ 0.15 U <sub>n</sub> ; DC: ≥ 0.1 U <sub>v</sub> |
| Operating range of supply voltage |             | see page 68  | see page 68  | see page 68  |
| Rated power consumption           |             | AC: 2.8 VA 50 Hz; 2.5 VA 60 Hz; DC: 1.5 W            | AC: 2.8 VA 50 Hz; 2.5 VA 60 Hz; DC: 1.5 W            | AC: 2.8 VA 50 Hz; 2.5 VA 60 Hz; DC: 1.5 W            |

### Insulation

|                             |  |   |   |   |
|-----------------------------|--|---|---|---|
| Insulation rated voltage    |  | 250 V AC                                  | 250 V AC                                  | 250 V AC                                  |
| Rated surge voltage         |  | 2500 V 1.2 / 50 μs                        | 2500 V 1.2 / 50 μs                        | 2500 V 1.2 / 50 μs                        |
| Overvoltage category        |  | III                                       | III                                       | III                                       |
| Insulation pollution degree |  | 3   | 3   | 3   |
| Dielectric strength         |  |   |   |   |
| • between coil and contacts |  | 2500 V AC type of insulation: basic       | 2500 V AC type of insulation: basic       | 2500 V AC type of insulation: basic       |
| • contact clearance         |  | 1500 V AC type of clearance: micro-disco. | 1500 V AC type of clearance: micro-disco. | 1500 V AC type of clearance: micro-disco. |
| • pole - pole               |  | 2000 V AC type of insulation: basic       | 2000 V AC type of insulation: basic       | 2000 V AC type of insulation: basic       |
| Contact - coil distance     |  |   |   |   |
| • clearance                 |  | ≥ 3 mm                                    | ≥ 3 mm                                    | ≥ 3 mm                                    |
| • creepage                  |  | ≥ 4.2 mm                                  | ≥ 4.2 mm                                  | ≥ 3.2 mm                                  |

### General Data

|                                    |  |  |  |  |
|------------------------------------|--|--|--|--|
| Operating / release time (typical) |  | AC: 12 ms / 10 ms; DC: 18 ms / 7 ms    | AC: 12 ms / 10 ms; DC: 18 ms / 7 ms    | AC: 12 ms / 10 ms; DC: 18 ms / 7 ms    |
| Electrical life                    |  |  |  |  |
| • resistive AC1                    |  | > 2 x 10 <sup>5</sup> ; 10 A. 250 V AC | > 2 x 10 <sup>5</sup> ; 10 A. 250 V AC | > 2 x 10 <sup>5</sup> ; 10 A. 250 V AC |
| • cos                              |  | see Fig. 2                             | see Fig. 2                             | see Fig. 2                             |
| Mechanical life (cycles)           |  | > 2 x 10 <sup>7</sup>                  | > 2 x 10 <sup>7</sup>                  | > 2 x 10 <sup>7</sup>                  |
| Dimensions (L x W x H)             |  | 35 x 35 x 54.4 mm                      | 35 x 35 x 54.4 mm                      | 35 x 42.5 x 54.5 mm                    |
| Weight                             |  | 83 g                                   | 83 g                                   | 95 g                                   |
| Ambient temperature                |  |  |  |  |
| • storage                          |  | -40...+85 °C                           | -40...+85 °C                           | -40...+85 °C                           |
| • operating                        |  | AC: -40...+55 °C DC: -40...+70 °C      | AC: -40...+55 °C DC: -40...+70 °C      | AC: -40...+55 °C DC: -40...+70 °C      |
| Cover protection category          |  | IP 40 PN-EN 60529                      | IP 40 PN-EN 60529                      | IP 40 PN-EN 60529                      |
| Environmental protection           |  | RTI PN-EN 116000-3                     | RTI PN-EN 116000-3                     | RTI PN-EN 116000-3                     |
| Shock resistance                   |  | 10 g                                   | 10 g                                   | 10 g                                   |
| Vibration resistance               |  | 5 g 10...150 Hz                        | 5 g 10...150 Hz                        | 5 g 10...150 Hz                        |
| Solder bath temperature            |  | max. 270 °C                            | max. 270 °C                            | max. 270 °C                            |
| Soldering time                     |  | max. 5 s                               | max. 5 s                               | max. 5 s                               |

### DPDT

#### CONNECTION DIAGRAM



#### DIMENSIONS

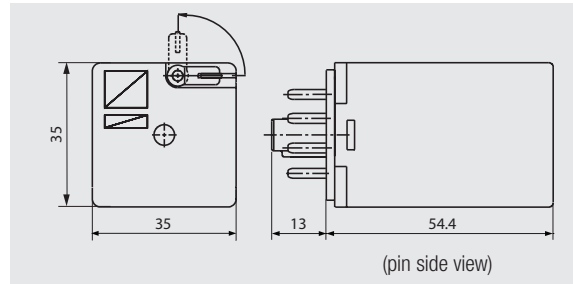

### 3PDT

#### CONNECTION DIAGRAM

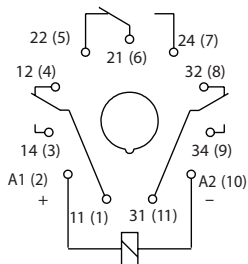

#### DIMENSIONS

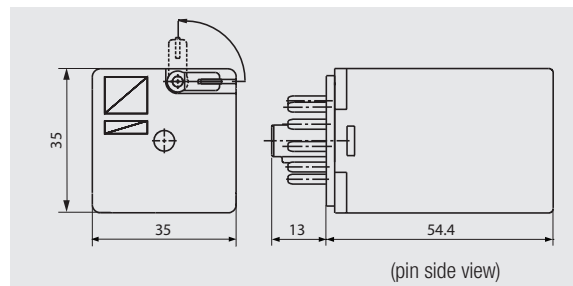

### 4PDT

#### CONNECTION DIAGRAM

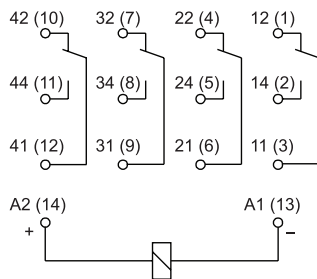

#### DIMENSIONS

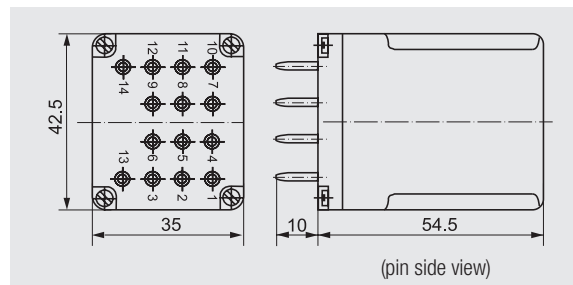

### LOAD CHARTS

Electrical life at AC resistive load. Switching frequency: 1200 cycles/hour Fig. 1



Electrical life reduction factor at AC inductive load Fig. 2

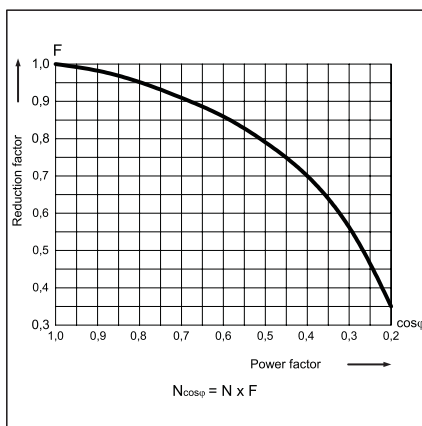

Max. DC breaking capacity A - resistive load DC1 B - inductive load L/R = 40 ms Fig. 3

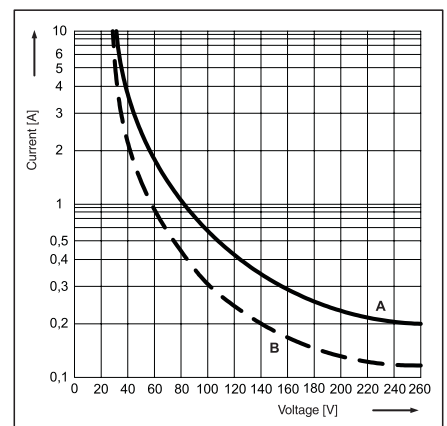

# R15

## Industrial Electromagnetic Relays

### R15 DPDT AC 50/60Hz & DC coil

| Part Number                   | Coil Voltage (V) | Coil Type  | Coil resistance at 20 °C in Ω | Coil operating range |                | Options* |    |     |
|-------------------------------|------------------|------------|-------------------------------|----------------------|----------------|----------|----|-----|
|                               |                  |            |                               | min. (at 20°C)       | max. (at 55°C) | -        | WT | WTL |
| ▶ <b>R15-2012-23-1012</b>     | 12               | DC         | 110                           | 9.6                  | 13.2           | x        |    |     |
| R15-2012-23-1012-WT           | 12               | DC         | 110                           | 9.6                  | 13.2           |          | x  |     |
| R15-2012-23-1012-WTL          | 12               | DC         | 110                           | 9.6                  | 13.2           |          |    | x   |
| ▶ <b>R15-2012-23-1024</b>     | 24               | DC         | 430                           | 19.2                 | 26.4           | x        |    |     |
| R15-2012-23-1024-WT           | 24               | DC         | 430                           | 19.2                 | 26.4           |          | x  |     |
| ▶ <b>R15-2012-23-1024-WTL</b> | 24               | DC         | 430                           | 19.2                 | 26.4           |          |    | x   |
| R15-2012-23-1110              | 110              | DC         | 9200                          | 88.0                 | 121.0          | x        |    |     |
| R15-2012-23-1110-WT           | 110              | DC         | 9200                          | 88.0                 | 121.0          |          | x  |     |
| R15-2012-23-1110-WTL          | 110              | DC         | 9200                          | 88.0                 | 121.0          |          |    | x   |
| ▶ <b>R15-2012-23-5024</b>     | 24               | AC 50/60Hz | 75                            | 19.2                 | 26.4           | x        |    |     |
| R15-2012-23-5024-WT           | 24               | AC 50/60Hz | 75                            | 19.2                 | 26.4           |          | x  |     |
| R15-2012-23-5024-WTL          | 24               | AC 50/60Hz | 75                            | 19.2                 | 26.4           |          |    | x   |
| ▶ <b>R15-2012-23-5120</b>     | 120              | AC 50/60Hz | 1910                          | 96.0                 | 132.0          | x        |    |     |
| R15-2012-23-5120-WT           | 120              | AC 50/60Hz | 1910                          | 96.0                 | 132.0          |          | x  |     |
| ▶ <b>R15-2012-23-5120-WTL</b> | 120              | AC 50/60Hz | 1910                          | 96.0                 | 132.0          |          |    | x   |
| ▶ <b>R15-2012-23-5230</b>     | 230              | AC 50/60Hz | 7080                          | 184.0                | 253.0          | x        |    |     |
| R15-2012-23-5230-WT           | 230              | AC 50/60Hz | 7080                          | 184.0                | 253.0          |          | x  |     |
| R15-2012-23-5230-WTL          | 230              | AC 50/60Hz | 7080                          | 184.0                | 253.0          |          |    | x   |

### R15 3PDT AC 50/60Hz & DC coil

| Part Number                   | Coil Voltage (V) | Coil Type  | Coil resistance at 20 °C in Ω | Coil operating range |                | Options* |    |     |
|-------------------------------|------------------|------------|-------------------------------|----------------------|----------------|----------|----|-----|
|                               |                  |            |                               | min. (at 20°C)       | max. (at 55°C) | -        | WT | WTL |
| ▶ <b>R15-2013-23-1012</b>     | 12               | DC         | 110                           | 9.6                  | 13.2           | x        |    |     |
| R15-2013-23-1012-WT           | 12               | DC         | 110                           | 9.6                  | 13.2           |          | x  |     |
| R15-2013-23-1012-WTL          | 12               | DC         | 110                           | 9.6                  | 13.2           |          |    | x   |
| ▶ <b>R15-2013-23-1024</b>     | 24               | DC         | 430                           | 19.2                 | 26.4           | x        |    |     |
| R15-2013-23-1024-WT           | 24               | DC         | 430                           | 19.2                 | 26.4           |          | x  |     |
| ▶ <b>R15-2013-23-1024-WTL</b> | 24               | DC         | 430                           | 19.2                 | 26.4           |          |    | x   |
| R15-2013-23-1110              | 110              | DC         | 9200                          | 88.0                 | 121.0          | x        |    |     |
| R15-2013-23-1110-WT           | 110              | DC         | 9200                          | 88.0                 | 121.0          |          | x  |     |
| R15-2013-23-1110-WTL          | 110              | DC         | 9200                          | 88.0                 | 121.0          |          |    | x   |
| ▶ <b>R15-2013-23-5024</b>     | 24               | AC 50/60Hz | 75                            | 19.2                 | 26.4           | x        |    |     |
| R15-2013-23-5024-WT           | 24               | AC 50/60Hz | 75                            | 19.2                 | 26.4           |          | x  |     |
| R15-2013-23-5024-WTL          | 24               | AC 50/60Hz | 75                            | 19.2                 | 26.4           |          |    | x   |
| ▶ <b>R15-2013-23-5120</b>     | 120              | AC 50/60Hz | 1910                          | 96.0                 | 132.0          | x        |    |     |
| R15-2013-23-5120-WT           | 120              | AC 50/60Hz | 1910                          | 96.0                 | 132.0          |          | x  |     |
| ▶ <b>R15-2013-23-5120-WTL</b> | 120              | AC 50/60Hz | 1910                          | 96.0                 | 132.0          |          |    | x   |
| ▶ <b>R15-2013-23-5230</b>     | 230              | AC 50/60Hz | 7080                          | 184.0                | 253.0          | x        |    |     |
| R15-2013-23-5230-WT           | 230              | AC 50/60Hz | 7080                          | 184.0                | 253.0          |          | x  |     |
| R15-2013-23-5230-WTL          | 230              | AC 50/60Hz | 7080                          | 184.0                | 253.0          |          |    | x   |

### R15 4PDT AC 50/60Hz & DC coil

| Part Number                 | Coil Voltage (V) | Coil Type | Coil resistance at 20 °C in Ω | Coil operating range |                | Options* |   |    |     |
|-----------------------------|------------------|-----------|-------------------------------|----------------------|----------------|----------|---|----|-----|
|                             |                  |           |                               | min. (at 20°C)       | max. (at 55°C) | -        | K | WT | WTL |
| R15-1014-23-1012            | 12               | DC        | 110                           | 9.6                  | 13.2           | x        |   |    |     |
| R15-1014-23-1012-K          | 12               | DC        | 110                           | 9.6                  | 13.2           |          | x |    |     |
| R15-1014-23-1012-L          | 12               | DC        | 110                           | 9.6                  | 13.2           |          |   | x  |     |
| R15-1014-23-1012-D          | 12               | DC        | 110                           | 9.6                  | 13.2           |          |   |    | x   |
| R15-1014-23-1024            | 24               | DC        | 430                           | 19.2                 | 26.4           | x        |   |    |     |
| R15-1014-23-1024-K          | 24               | DC        | 430                           | 19.2                 | 26.4           |          | x |    |     |
| ▶ <b>R15-1014-23-1024-L</b> | 24               | DC        | 430                           | 19.2                 | 26.4           |          |   | x  |     |
| R15-1014-23-1024-D          | 24               | DC        | 430                           | 19.2                 | 26.4           |          |   |    | x   |
| R15-1014-23-1110            | 110              | DC        | 9200                          | 88.0                 | 121.0          | x        |   |    |     |
| R15-1014-23-1110-K          | 110              | DC        | 9200                          | 88.0                 | 121.0          |          | x |    |     |
| R15-1014-23-1110-L          | 110              | DC        | 9200                          | 88.0                 | 121.0          |          |   | x  |     |
| R15-1014-23-1110-D          | 110              | DC        | 9200                          | 88.0                 | 121.0          |          |   |    | x   |
| R15-1014-23-3024            | 24               | AC 50Hz   | 72                            | 19.2                 | 26.4           | x        |   |    |     |
| R15-1014-23-3024-K          | 24               | AC 50Hz   | 72                            | 19.2                 | 26.4           |          | x |    |     |
| R15-1014-23-3024-L          | 24               | AC 50Hz   | 72                            | 19.2                 | 26.4           |          |   | x  |     |
| R15-1014-23-3024-D          | 24               | AC 50Hz   | 72                            | 19.2                 | 26.4           |          |   |    | x   |
| R15-1014-23-3120            | 120              | AC 50Hz   | 2300                          | 96.0                 | 132.0          | x        |   |    |     |
| R15-1014-23-3120-K          | 120              | AC 50Hz   | 2300                          | 96.0                 | 132.0          |          | x |    |     |
| R15-1014-23-3120-L          | 120              | AC 50Hz   | 2300                          | 96.0                 | 132.0          |          |   | x  |     |
| R15-1014-23-3120-D          | 120              | AC 50Hz   | 2300                          | 96.0                 | 132.0          |          |   |    | x   |
| R15-1014-23-3230            | 230              | AC 50Hz   | 7900                          | 184.0                | 253.0          | x        |   |    |     |
| R15-1014-23-3230-K          | 230              | AC 50Hz   | 7900                          | 184.0                | 253.0          |          | x |    |     |
| R15-1014-23-3230-L          | 230              | AC 50Hz   | 7900                          | 184.0                | 253.0          |          |   | x  |     |
| R15-1014-23-3230-D          | 230              | AC 50Hz   | 7900                          | 184.0                | 253.0          |          |   |    | x   |
| R15-1014-23-6120            | 120              | AC 60Hz   | 2000                          | 96.0                 | 132.0          | x        |   |    |     |
| R15-1014-23-6120-K          | 120              | AC 60Hz   | 2000                          | 96.0                 | 132.0          |          | x |    |     |
| ▶ <b>R15-1014-23-6120-L</b> | 120              | AC 60Hz   | 2000                          | 96.0                 | 132.0          |          |   | x  |     |
| R15-1014-23-6120-D          | 120              | AC 60Hz   | 2000                          | 96.0                 | 132.0          |          |   |    | x   |
| R15-1014-23-6230            | 230              | AC 60Hz   | 7000                          | 184.0                | 253.0          | x        |   |    |     |
| R15-1014-23-6230-K          | 230              | AC 60Hz   | 7000                          | 184.0                | 253.0          |          | x |    |     |
| R15-1014-23-6230-L          | 230              | AC 60Hz   | 7000                          | 184.0                | 253.0          |          |   | x  |     |
| R15-1014-23-6230-D          | 230              | AC 60Hz   | 7000                          | 184.0                | 253.0          |          |   |    | x   |

WT = with mechanical indicator + lockable front test button; WTL = with mechanical indicator + lockable front test button + light indicator (LED)  
 K = with test button without block function; L = with light indicator (LED); D = with surge suppression element (diode); other options available upon request

▶ **BOLD** - Regular stocked items.

### GZP8 for R15 DPDT

Screw terminals  
 Max. tightening moment for the terminal: 0.5 Nm  
 35 mm rail mount  
 acc. to PN-EN 60715  
 or on panel mounting  
 73 x 38.2 x 27.2 mm Two poles  
 12 A, 300 V AC



GZP8

#### CONNECTION DIAGRAM



#### DIMENSIONS



E22891



Time module COM3T



GZP-0035



GZP-0054

### PZ8 for R15 DPDT

Screw terminals  
 Max. tightening moment for the terminal: : 0.7 Nm  
 35 mm rail mount  
 acc. to PN-EN 60715  
 or on panel mounting  
 68.2 x 38 x 24.2 mm  
 Two poles  
 10 A, 250 V AC



PZ8

#### CONNECTION DIAGRAM



#### DIMENSIONS

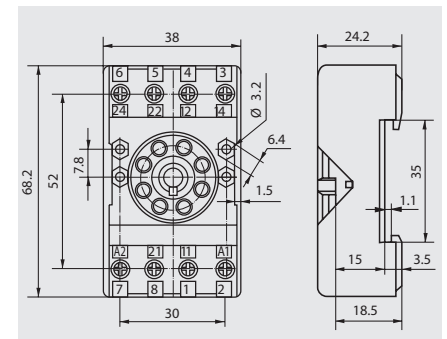

E105728



PZ11 0031

### GZP11 for R15 3PDT

Screw terminals  
 Max. tightening moment for the terminal: : 0,5 Nm  
 35 mm rail mount  
 acc. to PN-EN 60715  
 or on panel mounting  
 73 x 38.2 x 27.2 mm  
 Three poles  
 12 A, 300 V AC



GZP11

#### CONNECTION DIAGRAM

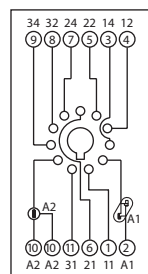

#### DIMENSIONS



E22891



Time module COM3T



GZP-0035



GZP-0054

All accessories are sold separately.

# R15

## Industrial Electromagnetic Relays - Plug-in Sockets and Accessories

### PZ11 for R15 3PDT

Screw terminals  
 Max. tightening moment  
 for the terminal: : 0.7 Nm  
 35 mm rail mount  
 acc. to PN-EN 60715  
 or on panel mounting  
 68.2 x 38 x 24.2 mm  
 Three poles  
 10 A, 250 V AC



PZ11



PZ11 0031

#### CONNECTION DIAGRAM



#### DIMENSIONS



E105728

### GZ14U for R15 4PDT

Screw terminals  
 Max. tightening moment  
 for the terminal: : 0.7 Nm  
 35 mm rail mount  
 acc. to PN-EN 60715  
 96.8 x 46.2 x 33.3 mm  
 Four poles  
 10 A, 250 V AC



GZ14ZU



GZ14 0737

#### CONNECTION DIAGRAM

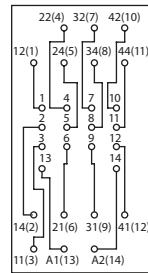

#### DIMENSIONS

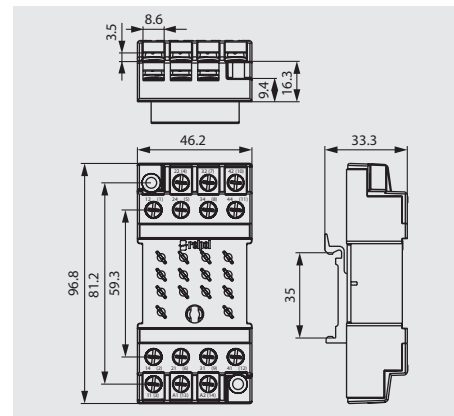

See Relay Socket Combinations on pages 104-109

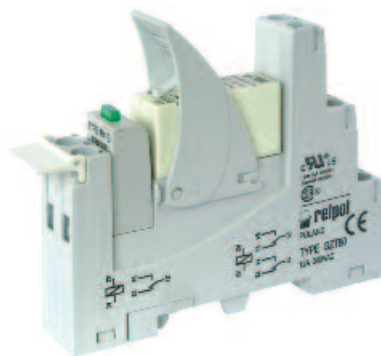

All accessories are sold separately.

# Altech Custom Assemblies



**Altech provides quick turnaround  
and competitive prices on assemblies.**

For complete assemblies contact Altech.

Компания «Life Electronics» занимается поставками электронных компонентов импортного и отечественного производства от производителей и со складов крупных дистрибьюторов Европы, Америки и Азии.

С конца 2013 года компания активно расширяет линейку поставок компонентов по направлению коаксиальный кабель, кварцевые генераторы и конденсаторы (керамические, пленочные, электролитические), за счёт заключения дистрибьюторских договоров

Мы предлагаем:

- Конкурентоспособные цены и скидки постоянным клиентам.
- Специальные условия для постоянных клиентов.
- Подбор аналогов.
- Поставку компонентов в любых объемах, удовлетворяющих вашим потребностям.
- Приемлемые сроки поставки, возможна ускоренная поставка.
- Доставку товара в любую точку России и стран СНГ.
- Комплексную поставку.
- Работу по проектам и поставку образцов.
- Формирование склада под заказчика.
- Сертификаты соответствия на поставляемую продукцию (по желанию клиента).
- Тестирование поставляемой продукции.
- Поставку компонентов, требующих военную и космическую приемку.
- Входной контроль качества.
- Наличие сертификата ISO.

В составе нашей компании организован Конструкторский отдел, призванный помогать разработчикам, и инженерам.

Конструкторский отдел помогает осуществить:

- Регистрацию проекта у производителя компонентов.
- Техническую поддержку проекта.
- Защиту от снятия компонента с производства.
- Оценку стоимости проекта по компонентам.
- Изготовление тестовой платы монтаж и пусконаладочные работы.



Тел: +7 (812) 336 43 04 (многоканальный)  
Email: [org@lifeelectronics.ru](mailto:org@lifeelectronics.ru)