

Micropower dual CMOS voltage comparators

Datasheet - production data

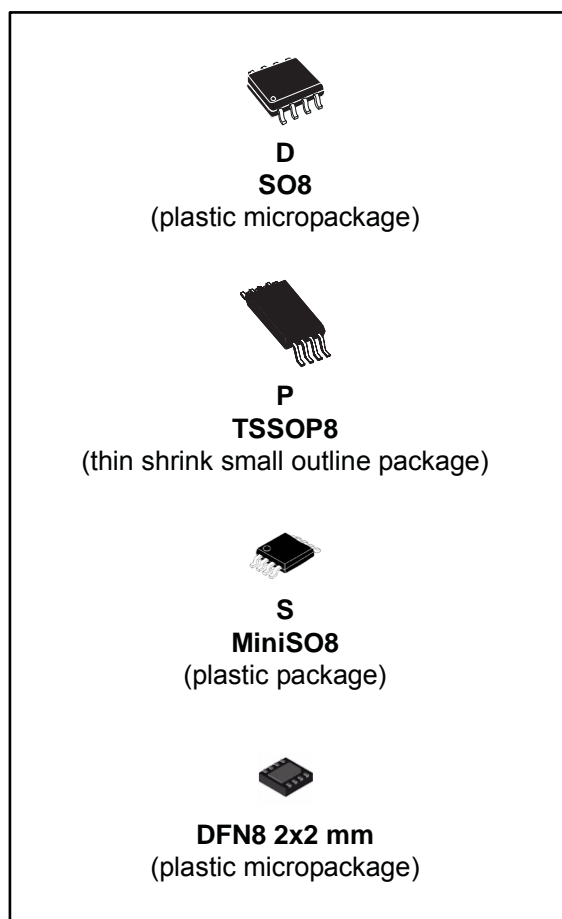

Features

- Low supply current: 5 μ A typ. per comparator
- Wide single supply range 2.7 V to 16 V or dual supplies (± 1.35 V to ± 8 V)
- Extremely low input bias current: 1 pA typ.

- Input common-mode voltage range includes ground
- Open drain output
- High input impedance: 10^{12} Ω typ
- Fast response time: 2 μ s typ. for 5 mV overdrive
- ESD tolerance: 4 kV HBM, 200 V MM

Related products

- Pin-to-pin and functionally compatible with the dual CMOS TS393 comparators
- See the TSX3702 for push-pull output

Applications

- Automotive
- Industrial

Description

The TSX393 is a micropower CMOS dual voltage comparator which exhibits a very low current consumption of 5 μ A typical per comparator. This device was designed as the improvement of the TS393: it shows a lower current consumption, a better input offset voltage, and an enhanced ESD tolerance. The TSX393 is fully specified over a wide temperature range and is proposed in automotive grade for the SO8 package. It is fully compatible with the TS393 CMOS comparator and is available with similar packages. New tiny packages (MiniSO8 and DFN8 2x2 mm) are also proposed for the TSX393 thus allowing even more integration on applications.

Contents

1	Package pin connections.....	3
2	Absolute maximum ratings.....	4
3	Operating conditions	5
4	Schematic diagram.....	6
5	Electrical characteristics	7
6	Application information (input voltages).....	14
7	Package information	15
	7.1 SO8 package information.....	16
	7.2 TSSOP8 package information.....	17
	7.3 DFN8 2x2 package information.....	18
	7.4 MiniSO8 package information	20
8	Ordering information.....	21
9	Revision history	22

1 Package pin connections

Figure 1: Pin connections top view

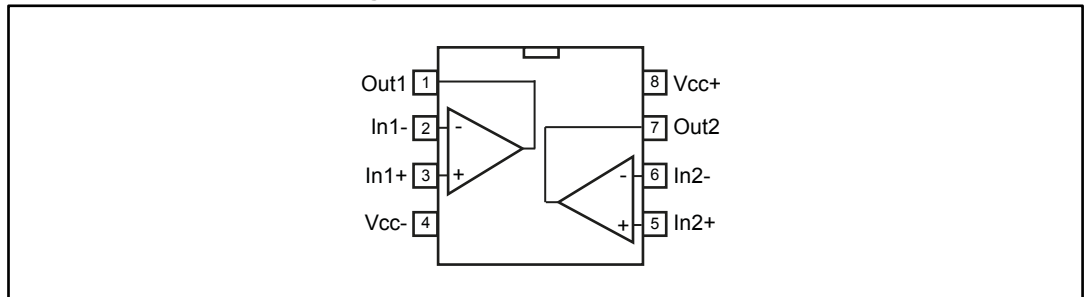

2 Absolute maximum ratings

Table 1: Absolute maximum ratings (AMR)

Symbol	Parameter	Value	Unit	
V _{CC+}	Supply voltage ⁽¹⁾	18	V	
V _{id}	Differential input voltage ⁽²⁾	±18		
V _{in}	Input voltage ⁽³⁾	-0.3 to 18		
V _o	Output voltage	18		
I _o	Output current	20	mA	
I _F	Forward current in ESD protection diodes on inputs ⁽⁴⁾	50		
T _j	Maximum junction temperature	150	°C	
R _{thja}	Thermal resistance junction to ambient ⁽⁵⁾	SO8	125	°C/W
		TSSOP8	120	
		MiniSO8	190	
		DFN8 2x2	115	
T _{stg}	Storage temperature range	-65 to 150	°C	
ESD	HBM: human body model ⁽⁶⁾	4000	V	
	MM: machine model ⁽⁷⁾	200		
	CDM: charged device model ⁽⁸⁾	1500		
	Latch-up immunity	200	mA	

Notes:

- (1) All voltage values, except the differential voltage, are with respect to network ground terminal
- (2) Differential voltages are the non-inverting input terminal with respect to the inverting input terminal
- (3) Excursions of input voltages may exceed the power supply level. As long as the common mode voltage (V_{icm} = (V_{in+}) + (V_{in-})/2) remains within the specified range, the comparator provides a stable output state. However, the maximum current of the input stage, through the ESD diodes (I_F), must be strictly observed.
- (4) Guaranteed by design
- (5) Short-circuits can cause excessive heating and destructive dissipation. Values are typical.
- (6) According to JEDEC standard JESD22-A114F
- (7) According to JEDEC standard JESD22-A115A
- (8) According to ANSI/ESD STM5.3.1

3 Operating conditions

Table 2: Operating conditions

Symbol	Parameter	Value	Unit
V_{CC^+}	Supply voltage	2.7 to 16	V
V_{icm}	Common mode input voltage range	0 to $(V_{CC^+}) - 1.5$	
	$T_{min} \leq T_{amb} \leq T_{max}$	0 to $(V_{CC^+}) - 2$	
T_{oper}	Operating free-air temperature range	-40 to 125	°C

4 Schematic diagram

Figure 2: Schematic diagram (one operator)

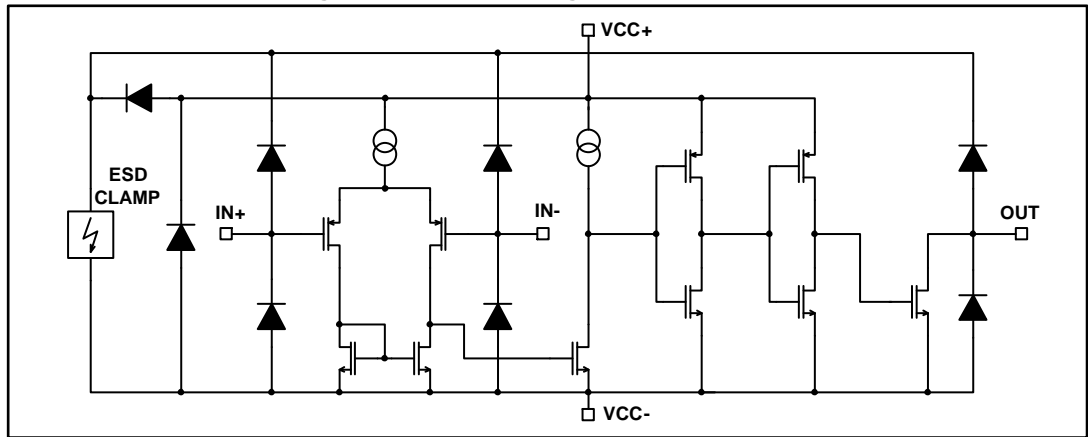

5 Electrical characteristics

Table 3: $V_{CC+} = 3\text{ V}$, $V_{CC-} = 0\text{ V}$, $T_{amb} = 25\text{ }^{\circ}\text{C}$ (unless otherwise specified)

Symbol	Parameter	Condition	Min.	Typ.	Max.	Unit
V_{io}	Input offset voltage ⁽¹⁾	$V_{icm} = 0\text{ V}$	-5	0.1	5	mV
		$T_{min} \leq T_{amb} \leq T_{max}$	-6		6	
I_{io}	Input offset current ⁽²⁾	$V_{icm} = V_{CC}/2$		1	10	pA
		$T_{min} \leq T_{amb} \leq T_{max}$			600	
I_{ib}	Input bias current ⁽²⁾	$V_{icm} = V_{CC}/2$		1	10	pA
		$T_{min} \leq T_{amb} \leq T_{max}$			1200	
CMR	Common-mode rejection ratio	$V_{icm} = 0\text{ to } (V_{CC+}) - 1.5\text{ V}$	58	73		dB
		$V_{icm} = 0\text{ to } (V_{CC+}) - 2\text{ V}$, $T_{min} \leq T_{amb} \leq T_{max}$	55			
SVR	Supply voltage rejection ratio	$V_{CC+} = 3\text{ V to } 5\text{ V}$, $V_{icm} = V_{CC}/2$	69	88		dB
		$T_{min} \leq T_{amb} \leq T_{max}$	69			
I_{OH}	High-level output voltage	$V_{id} = 1\text{ V}$, $V_{OH} = 3\text{ V}$		1	40	nA
		$T_{min} \leq T_{amb} \leq T_{max}$			1000	
V_{OL}	Low-level output voltage	$V_{id} = -1\text{ V}$, $I_{OL} = 4\text{ mA}$		300	400	mV
		$T_{min} \leq T_{amb} \leq T_{max}$			600	
I_{CC}	Supply current per comparator	No load, outputs low		5	6	μA
		$T_{min} \leq T_{amb} \leq T_{max}$			7	
		No load, outputs high		8	9	
		$T_{min} \leq T_{amb} \leq T_{max}$			11	
t_{PLH}	Response time low to high	$V_{icm} = 0\text{ V}$, $f = 10\text{ kHz}$, $R_L = 5.1\text{ k}\Omega$, $C_L = 50\text{ pF}$, overdrive = 5 mV		2.5		μs
		Overdrive = 100 mV		0.53	0.65	
		$T_{min} \leq T_{amb} \leq T_{max}$			0.7	
t_{PHL}	Response time high to low	$V_{icm} = 0\text{ V}$, $f = 10\text{ kHz}$, $R_L = 5.1\text{ k}\Omega$, $C_L = 50\text{ pF}$, overdrive = 5 mV		2.0		μs
		Overdrive = 100 mV		0.4	0.6	
		$T_{min} \leq T_{amb} \leq T_{max}$			0.65	
t_f	Fall time	$f = 10\text{ kHz}$, $C_L = 50\text{ pF}$, $R_L = 5.1\text{ k}\Omega$, overdrive 50 mV		39		ns

Notes:

(1)The specified offset voltage is the maximum value required to drive the output up to 2.5 V or down to 0.3 V

(2)Guaranteed by design

Table 4: VCC+ = 5 V, VCC- = 0 V, Tamb = 25 °C (unless otherwise specified)

Symbol	Parameter	Condition	Min.	Typ.	Max.	Unit
V _{io}	Input offset voltage ⁽¹⁾	V _{icm} = V _{CC} /2	-5	0.1	5	mV
		T _{min} ≤ T _{amb} ≤ T _{max}	-6		6	
I _{io}	Input offset current ⁽²⁾	V _{icm} = V _{CC} /2		1	10	pA
		T _{min} ≤ T _{amb} ≤ T _{max}			600	
I _{ib}	Input bias current ⁽²⁾	V _{icm} = V _{CC} /2		1	10	pA
		T _{min} ≤ T _{amb} ≤ T _{max}			1200	
CMR	Common-mode rejection ratio	V _{icm} = 0 to (V _{CC} ⁺) - 1.5 V	66	85		dB
		V _{icm} = 0 to (V _{CC} ⁺) - 2 V, T _{min} ≤ T _{amb} ≤ T _{max}	65			
SVR	Supply voltage rejection ratio	V _{CC} ⁺ = 5 V to 10 V, V _{icm} = V _{CC} /2	71	89		dB
		T _{min} ≤ T _{amb} ≤ T _{max}	70			
I _{OH}	High-level output voltage	V _{id} = 1 V, V _{OH} = 5 V		1	40	nA
		T _{min} ≤ T _{amb} ≤ T _{max}			1000	
V _{OL}	Low-level output voltage	V _{id} = -1 V, I _{OL} = 4 mA		180	250	mV
		T _{min} ≤ T _{amb} ≤ T _{max}			400	
I _{CC}	Supply current per comparator	No load, outputs low		5	8	μA
		T _{min} ≤ T _{amb} ≤ T _{max}			9	
		No load, outputs high		9	10	
		T _{min} ≤ T _{amb} ≤ T _{max}			11	
t _{PLH}	Response time low to high	V _{icm} = 0 V, f = 10 kHz, R _L = 5.1 kΩ, C _L = 50 pF, overdrive = 5 mV		2.5		μs
		Overdrive = 10 mV		1.6		
		Overdrive = 20 mV		1.0		
		Overdrive = 40 mV		0.7		
		Overdrive = 100 mV		0.52	0.6	
		T _{min} ≤ T _{amb} ≤ T _{max}			0.7	
		TTL input ⁽³⁾		0.55	0.7	
		T _{min} ≤ T _{amb} ≤ T _{max}			0.75	
t _{PHL}	Response time high to low	V _{icm} = 0 V, f = 10 kHz, R _L = 5.1 kΩ, C _L = 50 pF, overdrive = 5 mV		2.8		μs
		Overdrive = 10 mV		1.8		
		Overdrive = 20 mV		1.0		
		Overdrive = 40 mV		0.7		
		Overdrive = 100 mV		0.46	0.6	
		T _{min} ≤ T _{amb} ≤ T _{max}			0.7	
		TTL input ⁽³⁾		0.30	0.40	
		T _{min} ≤ T _{amb} ≤ T _{max}			0.50	

Symbol	Parameter	Condition	Min.	Typ.	Max.	Unit
t_f	Fall time	$f = 10 \text{ kHz}$, $C_L = 50 \text{ pF}$, $R_L = 5.1 \text{ k}\Omega$, overdrive 50 mV		30		ns

Notes:

(1)The specified offset voltage is the maximum value required to drive the output up to 4.5 V or down to 0.3 V

(2)Guaranteed by design

(3)A step from 0 V to 3 V is applied on one input while the other is fixed at 1.4 V. Response time is the time interval between the application of the input voltage step and the moment the output voltage reaches 50 % of its final value.

Table 5: $V_{CC+} = 16 \text{ V}$, $V_{CC-} = 0 \text{ V}$, $T_{amb} = 25 \text{ }^\circ\text{C}$ (unless otherwise specified)

Symbol	Parameter	Condition	Min.	Typ.	Max.	Unit
V_{io}	Input offset voltage ⁽¹⁾	$V_{icm} = V_{CC}/2$	-5	0.1	5	mV
		$T_{min} \leq T_{amb} \leq T_{max}$	-6		6	
I_{io}	Input offset current ⁽²⁾	$V_{icm} = V_{CC}/2$		1	10	pA
		$T_{min} \leq T_{amb} \leq T_{max}$			600	
I_{ib}	Input bias current ⁽²⁾	$V_{icm} = V_{CC}/2$		1	10	pA
		$T_{min} \leq T_{amb} \leq T_{max}$			1200	
CMR	Common-mode rejection ratio	$V_{icm} = 0$ to $(V_{CC+}) - 1.5 \text{ V}$	72	90		dB
		$V_{icm} = 0$ to $(V_{CC+}) - 2 \text{ V}$, $T_{min} \leq T_{amb} \leq T_{max}$	70			
SVR	Supply voltage rejection ratio	$V_{CC+} = 5 \text{ V}$ to 16 V , $V_{icm} = V_{CC}/2$	73	90		dB
		$T_{min} \leq T_{amb} \leq T_{max}$	72			
I_{OH}	High-level output voltage	$V_{id} = 1 \text{ V}$, $V_{OH} = 16 \text{ V}$		1	40	nA
		$T_{min} \leq T_{amb} \leq T_{max}$			1000	
V_{OL}	Low-level output voltage	$V_{id} = -1 \text{ V}$, $I_{OL} = 4 \text{ mA}$		90	150	mV
		$T_{min} \leq T_{amb} \leq T_{max}$			250	
I_{CC}	Supply current per comparator	No load, outputs low		7	9	μA
		$T_{min} \leq T_{amb} \leq T_{max}$			10	
		No load, outputs high		11	13	
		$T_{min} \leq T_{amb} \leq T_{max}$			14	
t_{PLH}	Response time low to high	$V_{icm} = 0 \text{ V}$, $f = 10 \text{ kHz}$, $R_L = 5.1 \text{ k}\Omega$, $C_L = 50 \text{ pF}$, overdrive = 5 mV		2.3		μs
		Overdrive = 10 mV		1.5		
		Overdrive = 20 mV		1.0		
		Overdrive = 40 mV		0.7		
		Overdrive = 100 mV		0.55	0.65	
		$T_{min} \leq T_{amb} \leq T_{max}$			0.70	
t_{PHL}	Response time high to low	$V_{icm} = 0 \text{ V}$, $f = 10 \text{ kHz}$, $R_L = 5.1 \text{ k}\Omega$, $C_L = 50 \text{ pF}$, overdrive = 5 mV		2.4		μs
		Overdrive = 10 mV		1.6		

Symbol	Parameter	Condition	Min.	Typ.	Max.	Unit
		Overdrive = 20 mV		1.0		
		Overdrive = 40 mV		0.7		
		Overdrive = 100 mV		0.55	0.70	
		$T_{min} \leq T_{amb} \leq T_{max}$			0.75	
t_f	Fall time	$f = 10 \text{ kHz}$, $C_L = 50 \text{ pF}$, $R_L = 5.1 \text{ k}\Omega$, overdrive 50 mV		11		ns

Notes:

⁽¹⁾The specified offset voltage is the maximum value required to drive the output up to 4.5 V or down to 0.3 V

⁽²⁾Guaranteed by design

Figure 3: Current consumption vs. supply voltage, output high

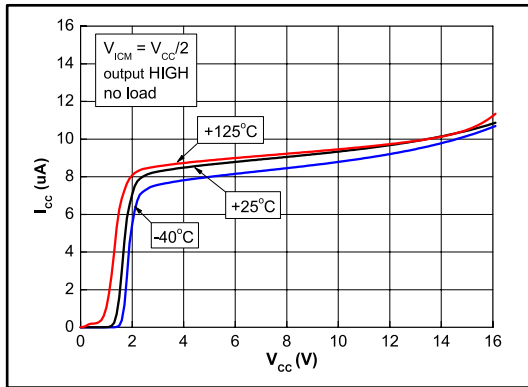

Figure 4: Current consumption vs. supply voltage, output low

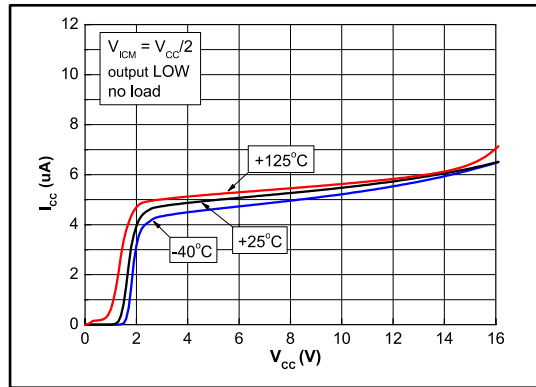

Figure 5: Current consumption vs. input common-mode voltage, output high

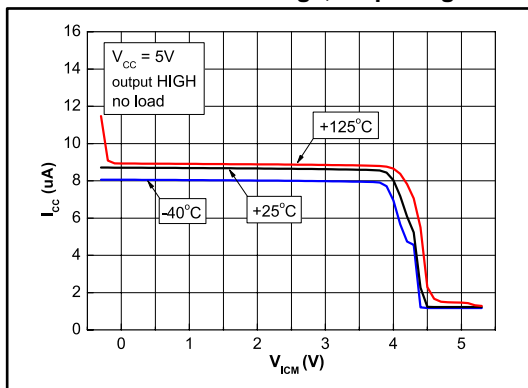

Figure 6: Current consumption vs. common-mode voltage, output low

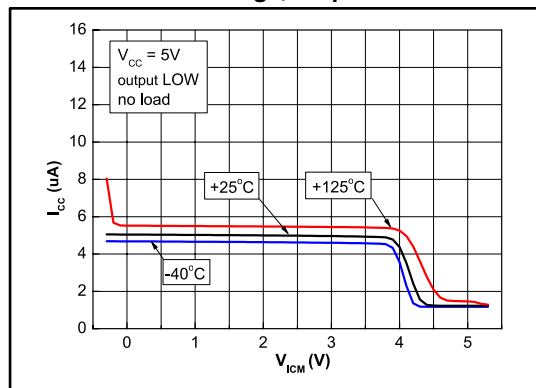

Figure 7: Output leakage current vs. output voltage, VCC = 5 V

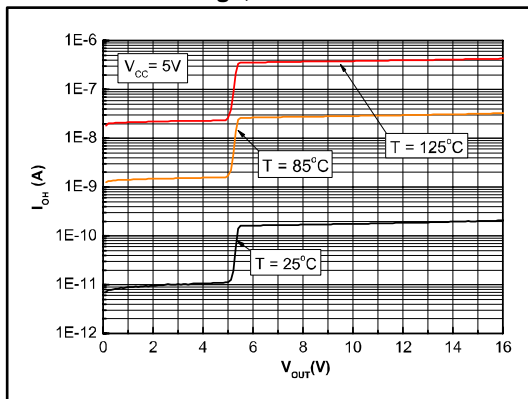

Figure 8: Output leakage current vs. supply voltage, VCC = 5 V

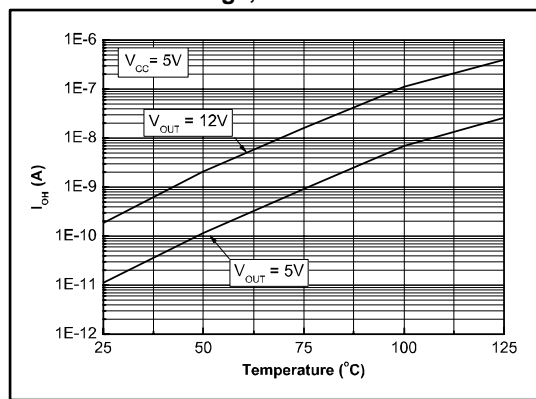

Figure 9: Output voltage drop vs. output sink current, VCC = 5 V

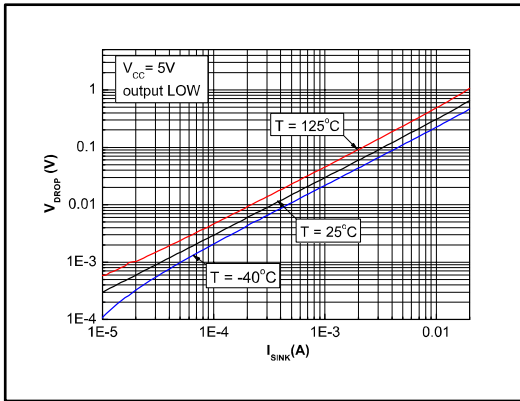

Figure 10: Output voltage drop vs. output sink current, VCC = 12 V

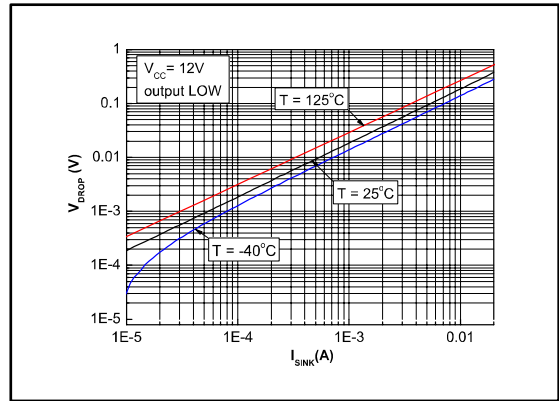

Figure 11: Input offset voltage distribution, VCC = 5 V

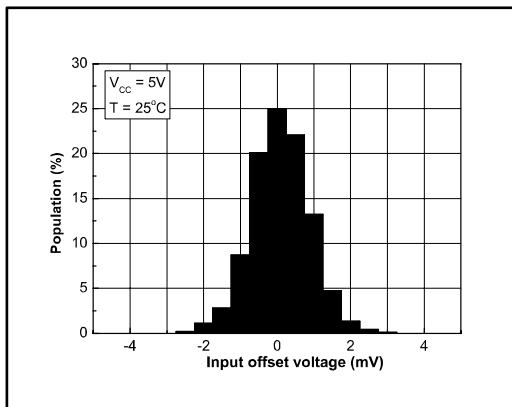

Figure 12: Input current vs input voltage, VCC = 5 V

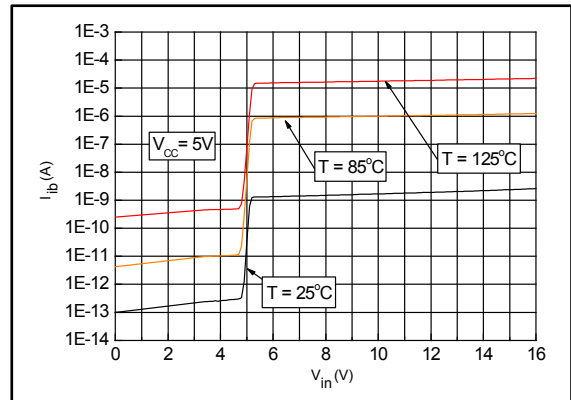

Figure 13: Propagation delay tPLH vs. input signal overdrive, VCC = 5 V

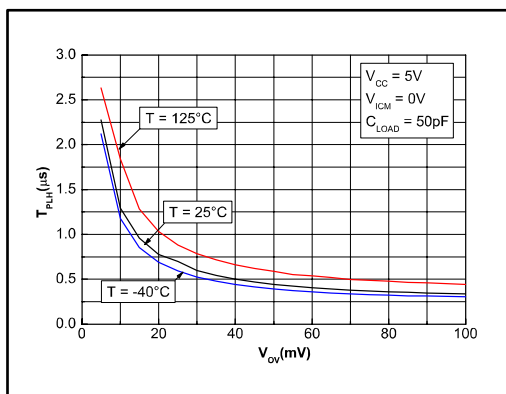

Figure 14: Propagation delay tPHL vs. input signal overdrive, VCC = 5 V

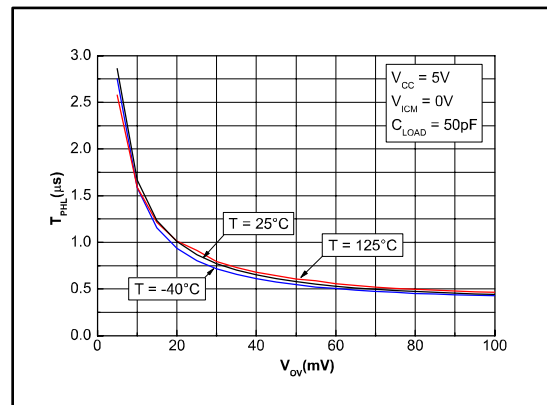

Figure 15: Propagation delay t_{PHL} vs. input signal overdrive, V_{CC} = 5 V

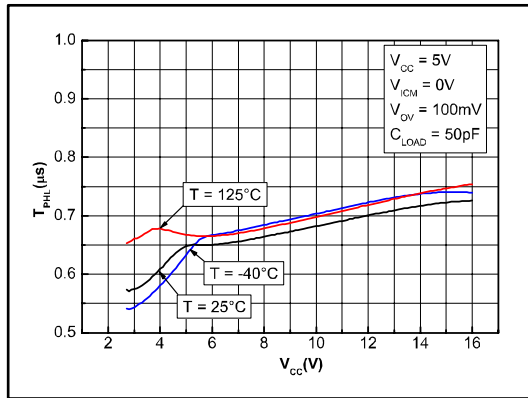
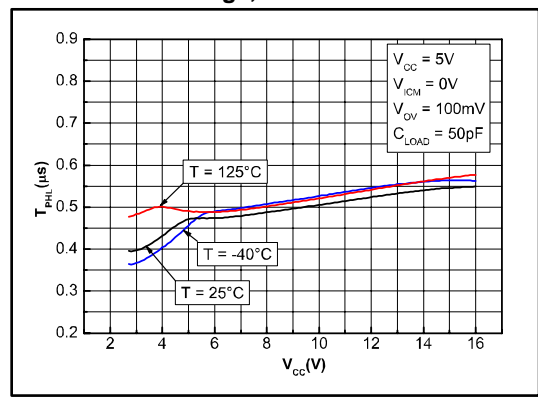

Figure 16: Propagation delay t_{PHL} vs. supply voltage, V_{CC} = 5 V



6 Application information (input voltages)

The ESD strategy used in the TSX393 (and shown in [Figure 2](#) allows input voltages from -0.3 V up to 16 V to be applied regardless of the V_{CC+} voltage. When $V_{IN} > V_{CC+}$ a leakage current goes from the input through the protection diode to the ESD clamp. This current is about 0.2 nA at 25 °C and about 250 nA at 125 °C. For a detailed input characteristic see [Figure 12](#). The device is designed to prevent phase reversal.

7 Package information

In order to meet environmental requirements, ST offers these devices in different grades of ECOPACK® packages, depending on their level of environmental compliance. ECOPACK® specifications, grade definitions and product status are available at: www.st.com. ECOPACK® is an ST trademark.

7.1 SO8 package information

Figure 17: SO8 package outline

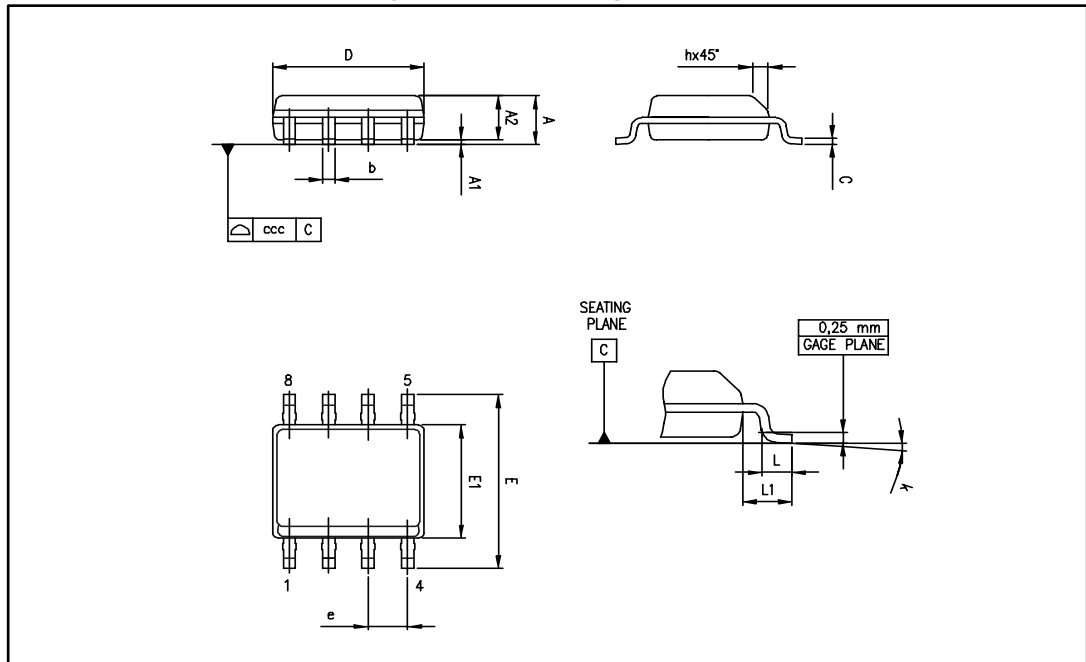

Table 6: SO8 mechanical data

Ref.	Dimensions					
	Millimeters			Inches		
	Min.	Typ.	Max.	Min.	Typ.	Max.
A			1.75			0.069
A1	0.10		0.25	0.004		0.010
A2	1.25			0.049		
b	0.28		0.48	0.011		0.019
c	0.17		0.23	0.007		0.010
D	4.80	4.90	5.00	0.189	0.193	0.197
E	5.80	6.00	6.20	0.228	0.236	0.244
E1	3.80	3.90	4.00	0.150	0.154	0.157
e		1.27			0.050	
h	0.25		0.50	0.010		0.020
L	0.40		1.27	0.016		0.050
L1		1.04			0.040	
k	0°		8°	0°		8°
ccc			0.10			0.004

7.2 TSSOP8 package information

Figure 18: TSSOP8 package outline

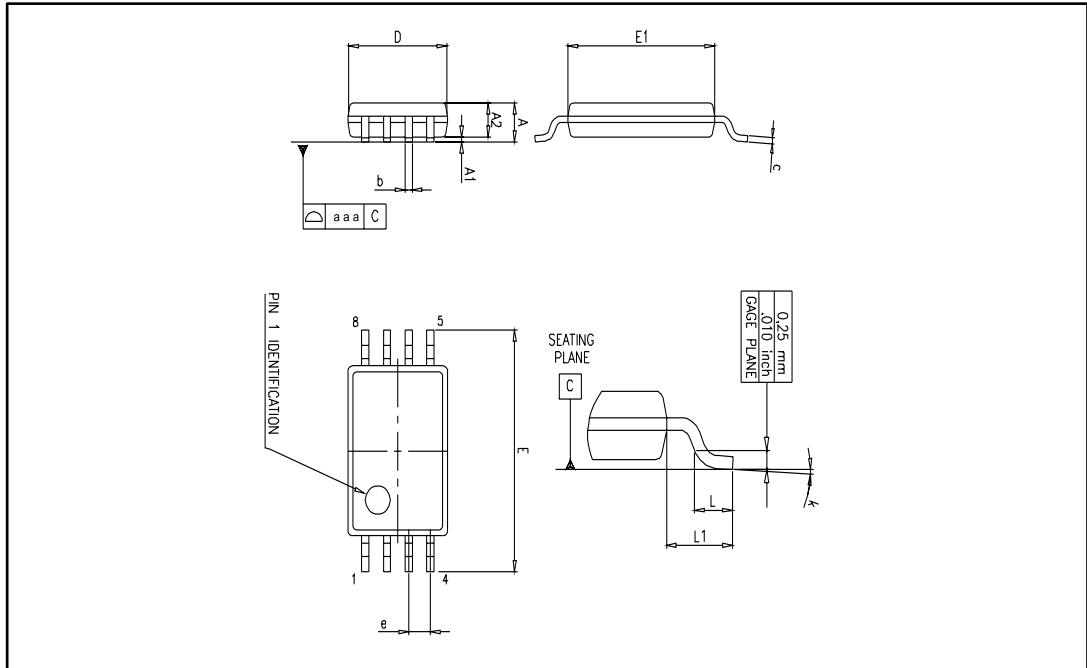

Table 7: TSSOP8 mechanical data

Ref.	Dimensions					
	Millimeters			Inches		
	Min.	Typ.	Max.	Min.	Typ.	Max.
A			1.2			0.047
A1	0.05		0.15	0.002		0.006
A2	0.80	1.00	1.05	0.031	0.039	0.041
b	0.19		0.30	0.007		0.012
c	0.09		0.20	0.004		0.008
D	2.90	3.00	3.10	0.114	0.118	0.122
E	6.20	6.40	6.60	0.244	0.252	0.260
E1	4.30	4.40	4.50	0.169	0.173	0.177
e		0.65			0.0256	
k	0°		8°	0°		8°
L	0.45	0.60	0.75	0.018	0.024	0.030
L1		1			0.039	
aaa		0.1			0.004	

7.3 DFN8 2x2 package information

Figure 19: DFN8 2x2 package outline

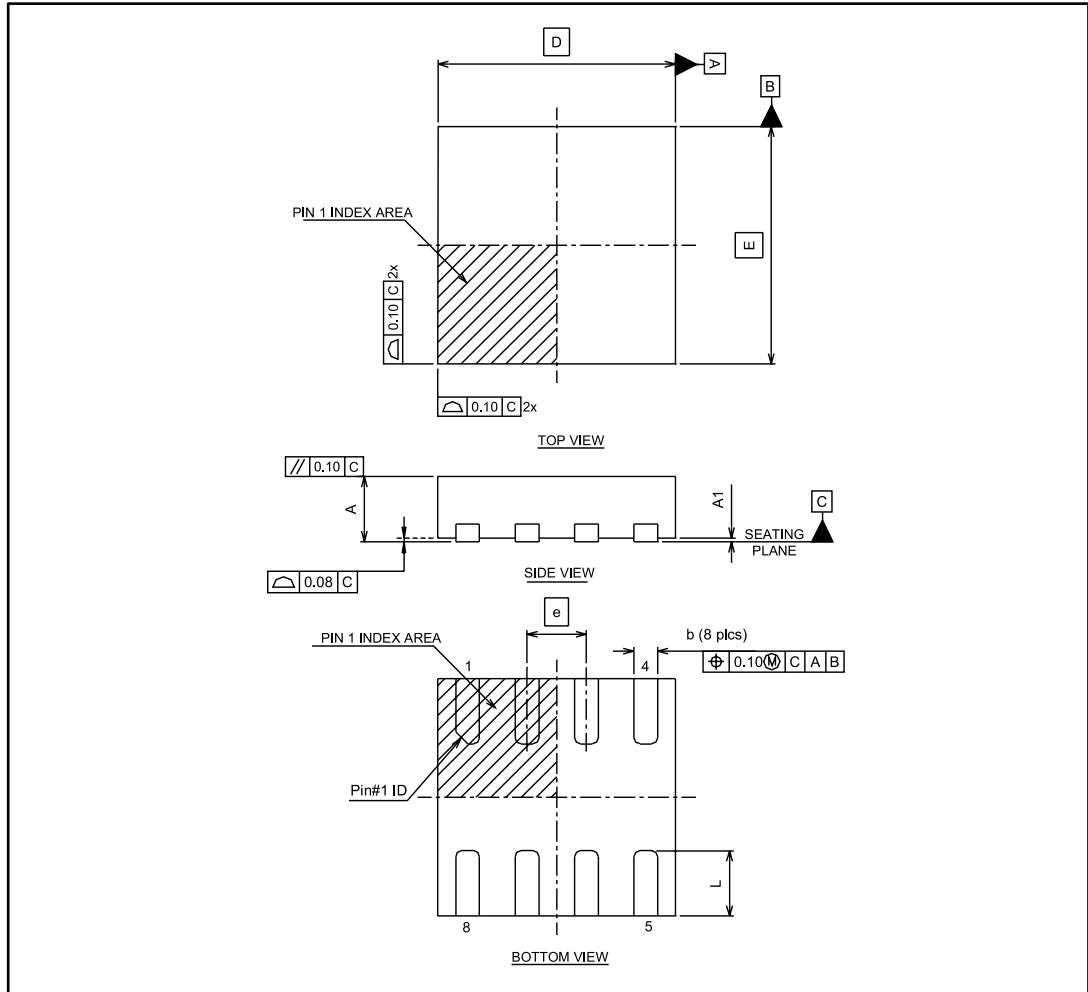
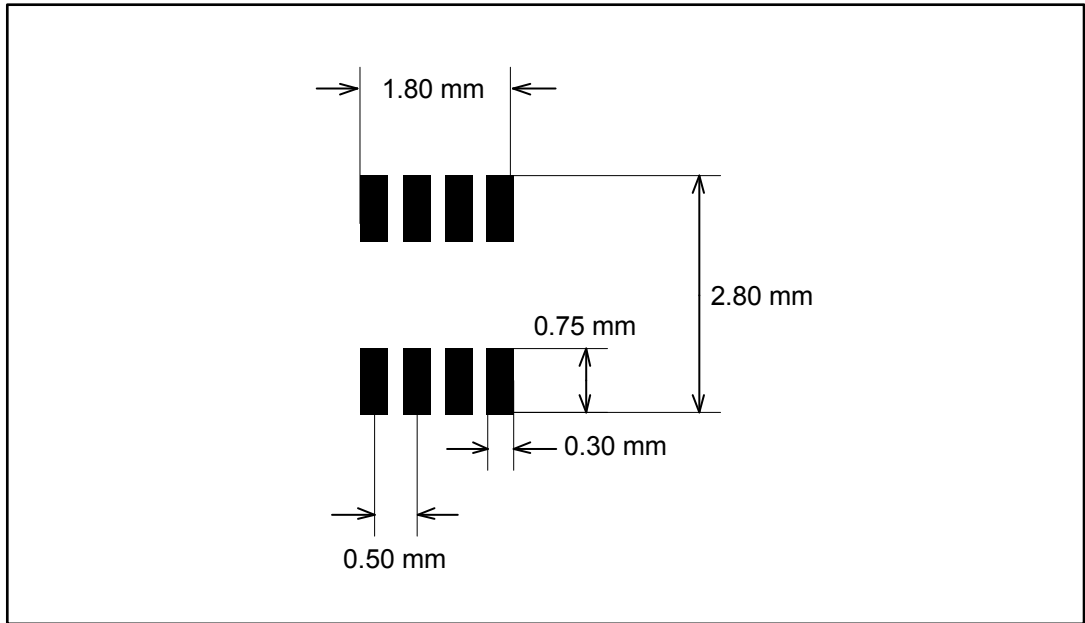

Table 8: DFN8 2x2 mechanical data

Ref.	Dimensions					
	Millimeters			Inches		
	Min.	Typ.	Max.	Min.	Typ.	Max.
A	0.70	0.75	0.80	0.028	0.030	0.031
A1	0.00	0.02	0.05	0.000	0.001	0.002
b	0.15	0.20	0.25	0.006	0.008	0.010
D		2.00			0.079	
E		2.00			0.079	
e		0.50			0.020	
L	0.045	0.55	0.65	0.018	0.022	0.026
N	8					

Figure 20: DFN8 2x2 recommended footprint



7.4 MiniSO8 package information

Figure 21: MiniSO8 package outline

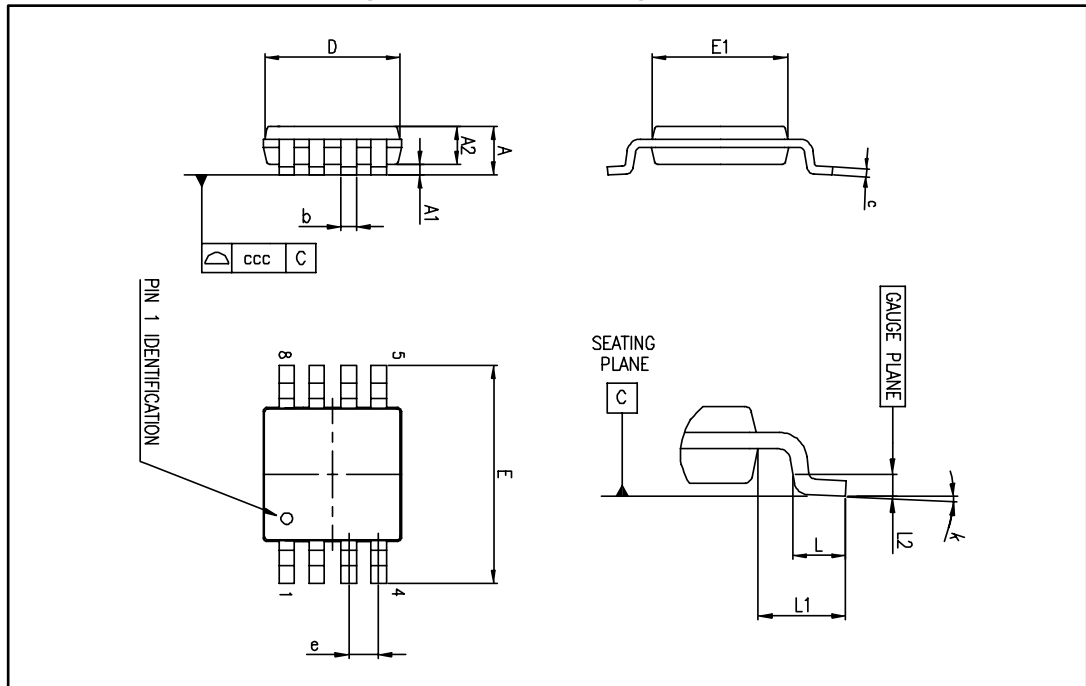

Table 9: MiniSO8 mechanical data

Ref.	Dimensions					
	Millimeters			Inches		
	Min.	Typ.	Max.	Min.	Typ.	Max.
A			1.1			0.043
A1	0		0.15	0		0.006
A2	0.75	0.85	0.95	0.030	0.033	0.037
b	0.22		0.40	0.009		0.016
c	0.08		0.23	0.003		0.009
D	2.80	3.00	3.20	0.11	0.118	0.126
E	4.65	4.90	5.15	0.183	0.193	0.203
E1	2.80	3.00	3.10	0.11	0.118	0.122
e		0.65			0.026	
L	0.40	0.60	0.80	0.016	0.024	0.031
L1		0.95			0.037	
L2		0.25			0.010	
k	0°		8°	0°		8°
ccc			0.10			0.004

8 Ordering information

Table 10: Order codes

Order code	Temperature range	Package	Packing	Marking
TSX393IDT	-40 °C, 125 °C	SO8	Tape and reel	SX393I
TSX393IPT		TSSOP8		SX393
TSX393IST		MiniSO8		K530
TSX393IQ2T		DFN8 2x2		K5K
TSX393IYDT ⁽¹⁾		SO8 (automotive grade)		SX393IY

Notes:

⁽¹⁾Qualified and characterized according to AEC Q100 and Q003 or equivalent, advanced screening according to AEC Q001 & Q002 or equivalent.

9 Revision history

Table 11: Document revision history

Date	Revision	Changes
30-Oct-2014	1	Initial release.
07-Sep-2015	2	Table 1: "Absoluet maximum ratings (AMR)": updated R_{thja} value for the DFN8 2x2 package. Section 7.3 "DFN8 2x2 package information": replaced pacakge outline, mechanical data, and recommended footprint by "non-exposed" pad information.
06-Jun-2016	3	Table 3, Table 4, and Table 5: updated t_{io} and t_{lib} temperature max values, updated VOL condition. In Table 3 only, updated t_{PHL} max value. In Table 5 only, updated IOH condition. Table 10: updated automotive footnote.
06-Jul-2017	4	Table 10 : updated automotive footnote.

IMPORTANT NOTICE – PLEASE READ CAREFULLY

STMicroelectronics NV and its subsidiaries ("ST") reserve the right to make changes, corrections, enhancements, modifications, and improvements to ST products and/or to this document at any time without notice. Purchasers should obtain the latest relevant information on ST products before placing orders. ST products are sold pursuant to ST's terms and conditions of sale in place at the time of order acknowledgement.

Purchasers are solely responsible for the choice, selection, and use of ST products and ST assumes no liability for application assistance or the design of Purchasers' products.

No license, express or implied, to any intellectual property right is granted by ST herein.

Resale of ST products with provisions different from the information set forth herein shall void any warranty granted by ST for such product.

ST and the ST logo are trademarks of ST. All other product or service names are the property of their respective owners.

Information in this document supersedes and replaces information previously supplied in any prior versions of this document.

© 2017 STMicroelectronics – All rights reserved

Компания «Life Electronics» занимается поставками электронных компонентов импортного и отечественного производства от производителей и со складов крупных дистрибьюторов Европы, Америки и Азии.

С конца 2013 года компания активно расширяет линейку поставок компонентов по направлению коаксиальный кабель, кварцевые генераторы и конденсаторы (керамические, пленочные, электролитические), за счёт заключения дистрибьюторских договоров

Мы предлагаем:

- Конкурентоспособные цены и скидки постоянным клиентам.
- Специальные условия для постоянных клиентов.
- Подбор аналогов.
- Поставку компонентов в любых объемах, удовлетворяющих вашим потребностям.
- Приемлемые сроки поставки, возможна ускоренная поставка.
- Доставку товара в любую точку России и стран СНГ.
- Комплексную поставку.
- Работу по проектам и поставку образцов.
- Формирование склада под заказчика.
- Сертификаты соответствия на поставляемую продукцию (по желанию клиента).
- Тестирование поставляемой продукции.
- Поставку компонентов, требующих военную и космическую приемку.
- Входной контроль качества.
- Наличие сертификата ISO.

В составе нашей компании организован Конструкторский отдел, призванный помогать разработчикам, и инженерам.

Конструкторский отдел помогает осуществить:

- Регистрацию проекта у производителя компонентов.
- Техническую поддержку проекта.
- Защиту от снятия компонента с производства.
- Оценку стоимости проекта по компонентам.
- Изготовление тестовой платы монтаж и пусконаладочные работы.



Тел: +7 (812) 336 43 04 (многоканальный)

Email: org@lifeelectronics.ru