

## INTRODUCTION

Two-stage filters provide high insertion loss for both line-to-line and line-to-ground emissions throughout the frequency range.

## COMPONENTS

PART NO.	C1 (uF)	C2 (uF)	L1 (mH)	L2 (mH)
03DPCG5S	0.33	0.33	10	10
03DPCW5S				
03DPDG3S			6.5	4.5
03DPDW3S				
06DPCG5	0.47	0.47	2.7	14
06DPCW5			2.7	14
06DPDW3			8.0	2.83
10DPCG5			0.66	5

PART NO.	C1 (uF)	C2 (pF)	L1 (mH)	L2 (mH)	R (K)
03DPCG5B/W5B	0.47	4700	9.8	9.8	470
06DPCG5B/W5B	1.0		7.8	7.8	220
12DPCG5B/W5B			3.25	3.25	
16DPGG5B/W5B/S5B			2.8	2.8	

PART NO.	Cx (uF)	L1 (mH)	L2 (mH)	Cy (pF)	R (Ω)
03DPCG5C	0.22	2.5	2.5	4700	1.0M
03DPCW5C					
06DPCG5C		0.97	0.97		
06DPCW5C					
12DPCG5C	0.47	0.58	0.58		470K
12DPCW5C					
16DPCG5C	0.33	0.65	0.65		1.0M
16DPCW5C					
16DPCS5C		1.0	0.60	0.60	
20DPCG5C					
20DPCS5C	1.0	0.60	0.60	220K	
30DPGS5C					10000

## SPECIFICATIONS

- Maximum leakage current each  
line-to-ground @ 115VAC 60Hz: 0.4mA (4700pF)  
@ 250VAC 50Hz: 0.8mA (4700pF)  
@ 115VAC 60Hz: 1.0mA (10000pF)  
@ 250VAC 50Hz: 2.0mA (10000pF)
- Hipot rating (one minute)  
line-to-ground: 2250VDC  
line-to-line: 1450VDC
- Operating frequency: 50/60Hz
- Rated voltage: 115/250VAC

## MINIMUM INSERTION LOSS IN dB

COMMON MODE (L-G) IN 50 OHM SYSTEM						
CURRENT RATING	FREQUENCY-MHz					
	.15	.50	1.0	5.0	10	30
3A(S)	50	70	70	60	50	40
3A	60	70	70	65	55	40
6A	58	70	65	65	60	50
10A	48	65	60	45	35	20
•06DPDW3	55	60	60	60	60	60
03DPCG5B/W5B	60	70	65	50	45	25
06DPCG5B/W5B	50	60	60	60	60	35
12DPCG5B/W5B	45	60	65	65	65	45
16DPGG5B/W5B/S5B	20	35	40	50	40	30
DIFFERENTIAL MODE (L-L) IN 50 OHM SYSTEM						
3A(S)	35	48	55	55	55	45
3A	36	55	60	55	55	45
6A	40	65	65	70	70	50
10A	30	40	45	55	60	25
03DPCG5B/W5B	30	45	45	45	45	25
•06DPDW3	40	60	60	60	60	60
06DPCG5B/W5B	45	50	50	55	55	45
12DPCG5B/W5B	45	45	50	50	50	50
16DPGG5B/W5B/S5B	7	55	50	50	50	40

- Maximum leakage current
  - 115VAC 60Hz: 0.5mA
  - 250VAC 50Hz: 1.0mA

## ELECTRICAL SCHEMATIC

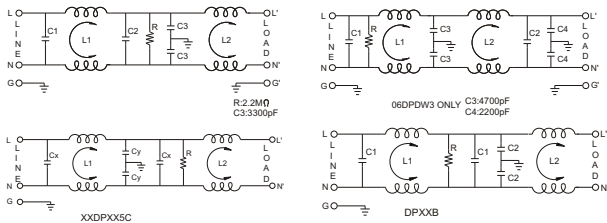

COMMON MODE (L-G) IN 50 OHM SYSTEM							
CURRENT RATING	STYLE	FREQUENCY-MHz					
		.15	.50	1.0	5.0	10	30
3A	CG5C, CW5C	45	60	60	55	45	35
6A	CG5C, CW5C	30	50	60	55	50	35
12A	CG5C, CW5C	15	25	35	55	55	35
16A	CG5C, CW5C, CS5C	20	35	45	60	50	35
20A	CG5C, CS5C	15	40	45	50	50	40
30A	GS5C	10	30	35	55	45	30
DIFFERENTIAL MODE (L-L) IN 50 OHM SYSTEM							
3A	CG5C, CW5C	12	45	45	45	45	45
6A	CG5C, CW5C	8	45	45	45	45	45
12A	CG5C, CW5C	12	40	40	35	35	40
16A	CG5C, CW5C, CS5C	12	40	40	45	45	50
20A	CG5C, CS5C	12	45	45	40	35	50
30A	GS5C	18	45	50	40	40	40

GENERAL PURPOSE TWO-STAGE FILTERS

## SERIES DIMENSIONS

CURRENT RATING	DIMENSIONS IN INCHES/mm					
	STYLE	A	B	C	D	E
3A	CG5S	$\frac{2.94}{74.7}$	$\frac{3.36}{85.3}$	$\frac{2.04}{51.8}$	$\frac{2.52}{64.0}$	$\frac{1.77}{45.0}$
3A	CW5S					
3A	DG3S	$\frac{2.55}{64.8}$	$\frac{2.04}{51.8}$	$\frac{1.77}{45.0}$	$\frac{1.575}{40.0}$	$\frac{0.63}{16.0}$
3A	DW3S					
6A	CG5					
6A	CW5	$\frac{5.63}{143.0}$	$\frac{6.02}{152.9}$	$\frac{2.02}{51.3}$	$\frac{5.27}{133.86}$	$\frac{2.77}{70.4}$
10A	CG5					
6A	DW3	$\frac{3.10}{78.7}$	$\frac{2.08}{52.8}$	$\frac{1.79}{45.5}$	$\frac{1.575}{40.0}$	$\frac{0.63}{16.0}$

CURRENT RATING	DIMENSIONS IN INCHES/mm							
	STYLE	A	B	C	D	E	F	G
3A	CG5B, CW5B	$\frac{2.95}{75.0}$	$\frac{3.34}{84.8}$	$\frac{2.05}{52.0}$	$\frac{2.58}{65.6}$	$\frac{1.54}{39.2}$	$\frac{4\text{min}}{101.6}$	
6A	CG5B, CW5B	$\frac{4.06}{103.0}$	$\frac{4.49}{114.0}$	$\frac{2.22}{56.5}$	$\frac{3.76}{95.5}$	$\frac{1.83}{46.4}$		
12A	CG5B, CW5B	$\frac{5.63}{143.0}$	$\frac{6.02}{152.9}$	$\frac{2.05}{52.0}$	$\frac{5.30}{134.7}$	$\frac{1.78}{45.3}$		
16A	GS5B	$\frac{3.89}{99.0}$	$\frac{4.31}{109.5}$	$\frac{4.72}{120.0}$	$\frac{2.0}{51.0}$	$\frac{2.62}{66.5}$	$\frac{3.38}{86.0}$	$\frac{2.28}{58.0}$

CURRENT RATING	DIMENSIONS IN INCHES/mm							
	STYLE	A	B	C	D	E	F	G
3A	CG5C, CW5C	$\frac{3.0}{75.0}$	$\frac{3.34}{84.8}$	$\frac{2.05}{52.0}$	$\frac{2.58}{65.6}$	$\frac{1.54}{39.2}$	$\frac{4\text{min}}{101.6}$	
6A	CG5C, CW5C	$\frac{5.63}{143.0}$	$\frac{6.02}{152.91}$	$\frac{2.02}{51.31}$	$\frac{5.27}{133.86}$	$\frac{2.27}{57.66}$		
12A	CG5C, CW5C	$\frac{3.0}{75.0}$	$\frac{3.34}{84.8}$	$\frac{2.05}{52.0}$	$\frac{2.58}{65.6}$	$\frac{1.15}{29.2}$		
20A	CG5C, CW5C	$\frac{4.05}{103}$	$\frac{4.49}{114}$	$\frac{2.22}{56.5}$	$\frac{3.76}{95.5}$	$\frac{1.86}{46.4}$		
30A	GS5C	$\frac{3.90}{99.0}$	$\frac{4.31}{109.5}$	$\frac{4.72}{120.0}$	$\frac{2.01}{51.0}$	$\frac{2.62}{66.5}$	$\frac{3.39}{86.0}$	$\frac{2.28}{58.0}$

## INSERTION LOSS (TYPICAL)

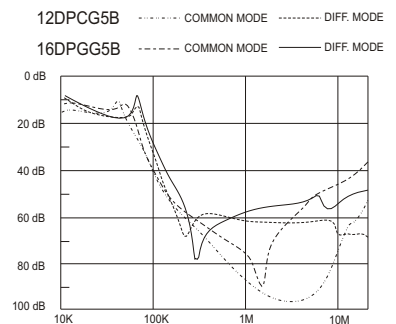
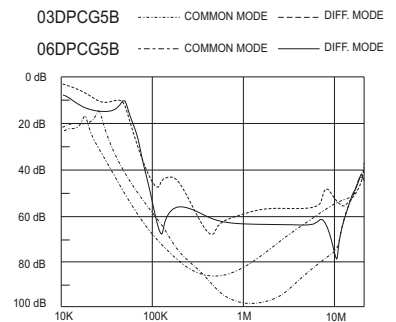
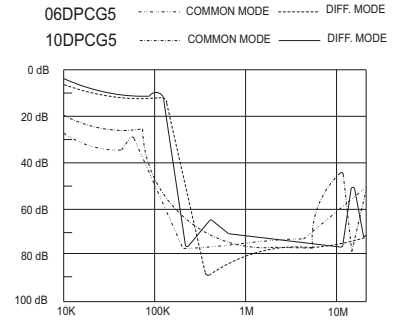
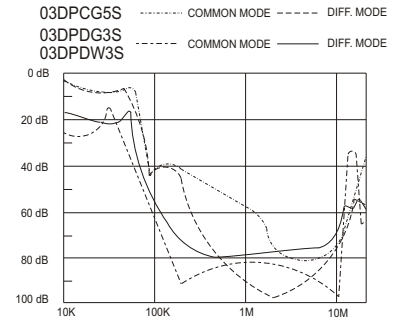

GENERAL PURPOSE TWO-STAGE FILTERS

# MECHANICAL CONSTRUCTION

CG5S

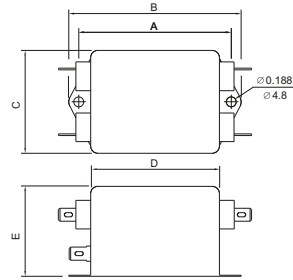
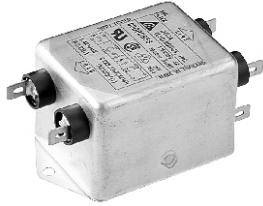

CG5

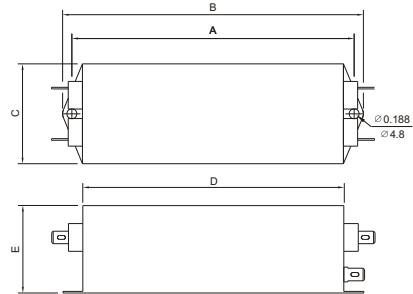

DG3S

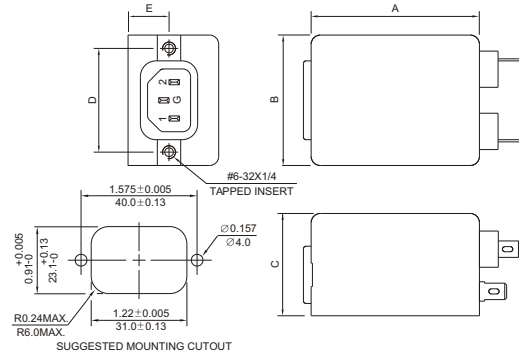

DW3/DW3S

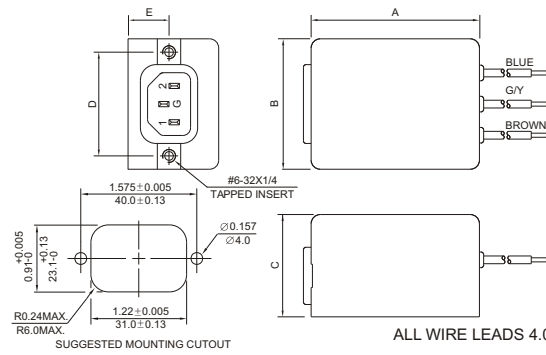

ALL WIRE LEADS 4.0" LONG MIN.

GS5B/GS5C

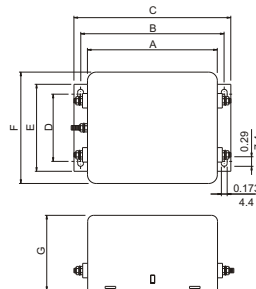
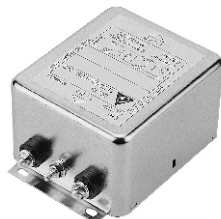

GENERAL PURPOSE TWO-STAGE FILTERS

# MECHANICAL CONSTRUCTION

GG5B

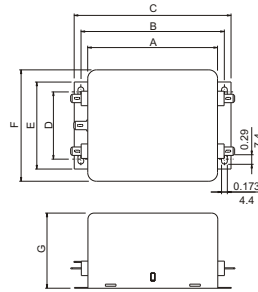

GW5B

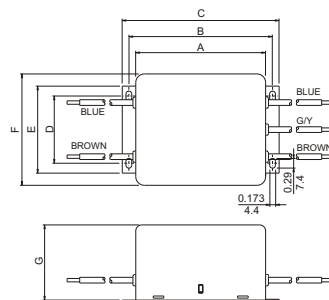
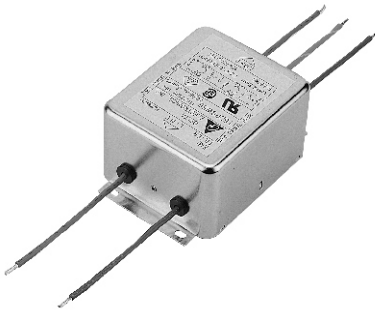

ALL WIRE LEADS 4.0" LONG MIN.

CG5B/CG5C

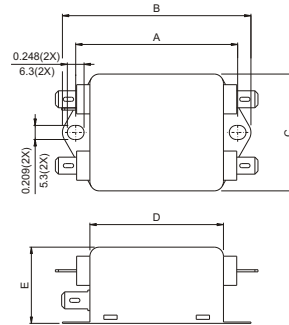
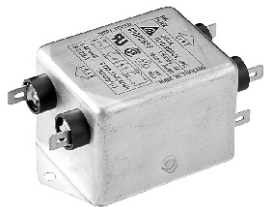

CW5/CW5B/CW5S/CW5C

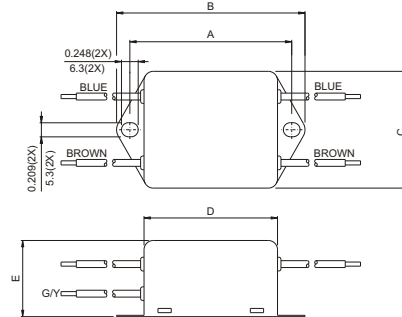

ALL WIRE LEADS 4.0" LONG MIN.

CS5C

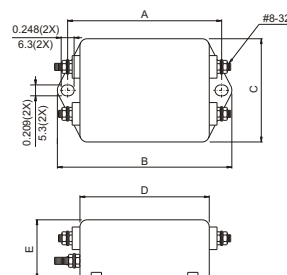

UNIT: INCH  
mm

Компания «Life Electronics» занимается поставками электронных компонентов импортного и отечественного производства от производителей и со складов крупных дистрибьюторов Европы, Америки и Азии.

С конца 2013 года компания активно расширяет линейку поставок компонентов по направлению коаксиальный кабель, кварцевые генераторы и конденсаторы (керамические, пленочные, электролитические), за счёт заключения дистрибьюторских договоров

Мы предлагаем:

- Конкурентоспособные цены и скидки постоянным клиентам.
- Специальные условия для постоянных клиентов.
- Подбор аналогов.
- Поставку компонентов в любых объемах, удовлетворяющих вашим потребностям.
- Приемлемые сроки поставки, возможна ускоренная поставка.
- Доставку товара в любую точку России и стран СНГ.
- Комплексную поставку.
- Работу по проектам и поставку образцов.
- Формирование склада под заказчика.
- Сертификаты соответствия на поставляемую продукцию (по желанию клиента).
- Тестирование поставляемой продукции.
- Поставку компонентов, требующих военную и космическую приемку.
- Входной контроль качества.
- Наличие сертификата ISO.

В составе нашей компании организован Конструкторский отдел, призванный помогать разработчикам, и инженерам.

Конструкторский отдел помогает осуществить:

- Регистрацию проекта у производителя компонентов.
- Техническую поддержку проекта.
- Защиту от снятия компонента с производства.
- Оценку стоимости проекта по компонентам.
- Изготовление тестовой платы монтаж и пусконаладочные работы.



Тел: +7 (812) 336 43 04 (многоканальный)

Email: [org@lifeelectronics.ru](mailto:org@lifeelectronics.ru)