

Description

The F1455 is a High Gain / High Linearity 1400 MHz to 2300 MHz TX Digital Variable Gain Amplifier used in transmitter applications.

The F1455 TX DVGA provides 32.8 dB maximum gain with +38.5 dBm OIP3 and 3.9 dB noise figure. Up to 29.5 dB gain control is achieved using the combination of a digital step attenuator (DSA) and a K_{LIN}^{TM} RF Digital Gain Amplifier. This device uses a single 5 V supply and 220 mA of I_{CC} .

This device is packaged in a 6 mm x 6 mm, 28-pin QFN with 50 Ω single-ended RF input and RF output impedances for ease of integration into the signal-path.

Competitive Advantage

In typical Base Stations, RF VGAs are used in the TX traffic paths to drive the transmit power amplifier. The F1455 TX DVGA offers very high reliability due to its construction from a monolithic silicon die in a QFN package. The F1455 is configured to provide an optimum balance of noise and linearity performance consisting of a K_{LIN}^{TM} RF amplifier, digital step attenuator (DSA) and a PA driver amplifier. The K_{LIN}^{TM} amplifier maintains the OIP3 and output P1dB performance over an extended attenuation range when compared to competitive devices.

Typical Applications

- Multi-mode, Multi-carrier Transmitters
- PCS1900 Base Stations
- DCS1800 Base Stations
- WiMAX and LTE Base Stations
- UMTS/WCDMA 3G Base Stations
- PHS/PAS Base Stations
- Public Safety Infrastructure

Features

- Broadband 1400 MHz to 2300 MHz
- 32.8 dB max gain
- 3.9 dB NF @ max gain (2000 MHz)
- 29.5 dB total gain control range, 0.5 dB step
- < 2 dB overshoot between gain transitions
- Maintains flat +23 dBm OP1dB for more than 13 dB gain adjustment range
- Maintains flat +38.5 dBm OIP3 for more than 15 dB gain adjustment range
- SPI interface for DSA control
- Single 5 V supply voltage
- $I_{CC} = 220$ mA
- Up to +105 °C T_{CASE} operating temperature
- 50 Ω input and output impedance
- Standby mode for power savings
- Pin compatible with 700 MHz and 2700 MHz versions
- 6 mm x 6 mm, 28-pin QFN package

Block Diagram

Figure 1. Block Diagram

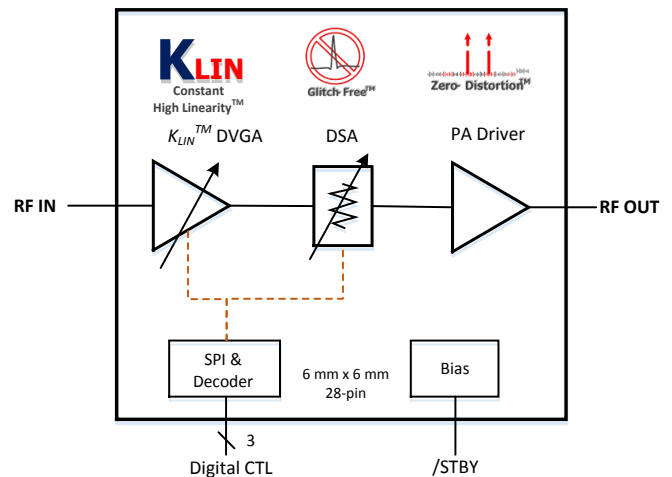

Pin Assignments

Figure 2. Pin Assignments for 6 mm x 6 mm x 0.9 mm QFN Package – Top View

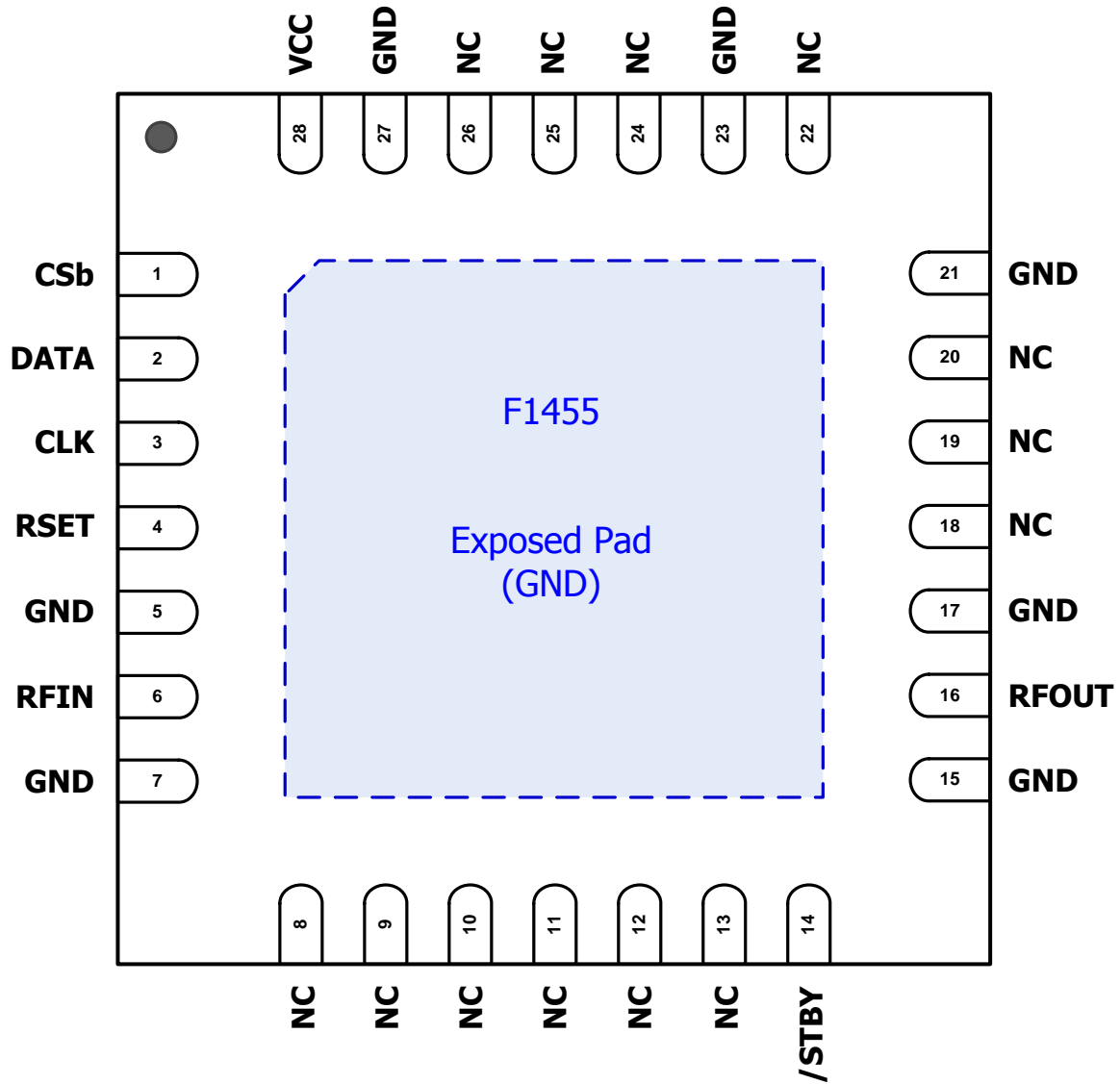

Pin Descriptions

Table 1. Pin Descriptions

Number	Name	Description
1	CSb	Chip Select Input: 1.8 V or 3.3 V logic compatible.
2	DATA	Data Input: 1.8 V or 3.3 V logic compatible.
3	CLK	Clock Input: 1.8 V or 3.3 V logic compatible.
4 [a]	RSET	Connect 1.74 k Ω external resistor to GND to set amplifier bias.
5, 7, 15, 17, 21, 23, 27	GND	Pins internally tied to exposed paddle. Connect to ground on PCB.
6	RFIN	RF input internally matched to 50 Ω . Must use external DC block.
8, 9, 10, 11, 12, 13, 18, 19, 20, 22, 24, 25, 26	NC	No internal connection. These pins can be left unconnected, voltage applied, or connected to ground (recommended).
14	/STBY	Standby pin. With Logic Low applied to this pin or with this pin left open, the amplifier is powered off with the SPI still powered on. With Logic High applied to this pin the part is in full operation mode.
16	RFOUT	RF output internally matched to 50 Ω . Must use external DC block.
28	VCC	5 V Power Supply. Connect to V_{cc} and use bypass capacitors as close to the pin as possible.
	— EP	Exposed Pad. Internally connected to GND. Solder this exposed pad to a PCB pad that uses multiple ground vias to provide heat transfer out of the device into the PCB ground planes. These multiple ground vias are also required to achieve the noted RF performance.

- a. External resistor on pin 4 used to optimize the overall device for DC current and linearity performance across the entire frequency band.

Absolute Maximum Ratings

Stresses above those listed below may cause permanent damage to the device. Functional operation of the device at these or any other conditions above those indicated in the operational section of this specification is not implied. Exposure to absolute maximum rating conditions for extended periods may affect device reliability.

Table 2. Absolute Maximum Ratings

Parameter	Symbol	Minimum	Maximum	Units
V _{CC} to GND	V _{CC}	-0.5	5.5	V
DATA, CSb, CLK, /STBY	V _{Cntrl}	-0.5	V _{CC}	V
RSET	I _{RSET}		+1.5	mA
RFIN externally applied DC voltage	V _{RFIN}	+1.4	+3.6	V
RFOUT externally applied DC voltage	V _{RFOUT}	V _{CC} - 0.15	V _{CC} + 0.15	V
RF Input Power (RFIN) applied for 24 hours max. [a]	P _{max_in}		+12	dBm
RF Output Power (RFOUT) present for 24 hours maximum [a]	P _{max_out}		+26	dBm
Continuous Power Dissipation	P _{diss}		1.75	W
Junction Temperature	T _j		150	°C
Storage Temperature Range	T _{st}	-65	150	°C
Lead Temperature (soldering, 10s)			260	°C
ElectroStatic Discharge – HBM (JEDEC/ESDA JS-001-2012)			2000 (Class 2)	V
ElectroStatic Discharge – CDM (JEDEC 22-C101F)			1000 (Class C3)	V

- a. Exposure to these maximum RF levels can result in significantly higher I_{CC} current draw due to overdriving the amplifier stages.

Recommended Operating Conditions

Table 3. Recommended Operating Conditions

Parameter	Symbol	Condition	Minimum	Typical	Maximum	Units
Power Supply Voltage	V_{CC}		4.75		5.25	V
Operating Temperature Range	T_{CASE}	Exposed Paddle	-40		+105	°C
RF Frequency Range	F_{RF}		1400		2300	MHz
Maximum Operating Average RF Output Power		$Z_S = Z_L = 50 \Omega$			14	dBm
RFIN Port Impedance	Z_{RFI}	Single Ended		50		Ω
RFOUT Port Impedance	Z_{RFO}	Single Ended		50		Ω

Electrical Characteristics - General

See Typical Application Circuit. Unless otherwise stated, specifications apply when operated as a TX VGA, $V_{CC} = +5.0\text{ V}$, $F_{RF} = 1.88\text{ GHz}$, $T_{CASE} = +25\text{ }^{\circ}\text{C}$, $/\text{STBY} = \text{High}$, $Z_S = Z_L = 50\ \Omega$, maximum gain setting.

Table 4. Electrical Characteristics

Parameter	Symbol	Condition	Minimum	Typical	Maximum	Units
Logic Input High Threshold	V_{IH}	JEDEC 1.8V or 3.3V logic	1.1 ^[a]		V_{CC}	V
Logic Input Low Threshold	V_{IL}	JEDEC 1.8V or 3.3V logic	-0.3		0.8	V
Logic Current	I_{IH}, I_{IL}	SPI	-1		+1	μA
	I_{STBY}	/STBY	-10		+10	
DC Current	I_{CC}			220	250	mA
Standby Current	I_{CC_STBY}	/STBY = Low		1	2	mA
Standby Switching Time	T_{STBY}	50% /STBY control to within 0.2 dB of the on state final gain value		250		ns
Gain Step	G_{STEP}	Least Significant Bit		0.5		dB
Maximum Attenuator Glitching	ATTN_G	Any state to state transition		2		dB
Maximum Step Error (DNL) [Over Recommended Supply Voltage Range, Operating Temperature Range, All Attenuation States]	$\text{ERROR}_{\text{STEP}}$	$F_{RF} = 1.40\text{ GHz}$	-0.47		+0.33	dB
		$F_{RF} = 1.70\text{ GHz}$	-0.38		+0.28	
		$F_{RF} = 1.88\text{ GHz}$	-0.30		+0.28	
		$F_{RF} = 2.00\text{ GHz}$	-0.27		+0.25	
		$F_{RF} = 2.10\text{ GHz}$	-0.26		+0.23	
		$F_{RF} = 2.30\text{ GHz}$	-0.20		+0.32	
Maximum Absolute Error (INL)	$\text{ERROR}_{\text{ABS}}$			0.8		dB
Gain Settling Time ^[c]	G_{ST}	50% of CSb to 10% / 90% RF		200		ns
SPI ^[d]						
Serial Clock Speed	F_{CLOCK}				25	MHz
CSb to CLK Setup Time	T_{LS}		5			ns
CLK to Data Hold Time	T_{H}		5			ns
CSb Trigger to CLK Setup Time	T_{LC}		5			ns

- Items in min/max columns in **bold italics** are Guaranteed by Test.
- Items in min/max columns that are not bold/italics are Guaranteed by Design Characterization.
- Excludes SPI write time.
- SPI 3 wire bus (refer to serial Control Mode Timing diagram).

Electrical Characteristics - RF

See Typical Application Circuit. Unless otherwise stated, specifications apply when operated as a TX VGA, $V_{CC} = +5.0\text{ V}$, $F_{RF} = 1.88\text{ GHz}$, $T_{CASE} = +25\text{ }^{\circ}\text{C}$, /STBY = High, $Z_S = Z_L = 50\ \Omega$, maximum gain setting. Evaluation Kit trace and connector losses are de-embedded.

Table 5. Electrical Characteristics

Parameter	Symbol	Condition	Minimum	Typical	Maximum	Units
RF Input Return Loss	RL_{RFIN}			15		dB
RF Output Return Loss	RL_{RFOUT}			13		dB
Gain - Max Gain Setting	G_{MAX}		31.0 [a]	32.8	34.6	dB
Gain - Min Gain Setting	G_{MIN}	Max attenuation	1.0	2.8	4.6	dB
Gain Flatness	G_{FLAT}	$F_{RF} = 1800\text{ MHz to }2200\text{ MHz}$		0.7 [c]		dB
Noise Figure	NF	0 dB attenuation		3.9		dB
		10 dB attenuation		6.8		
		20 dB attenuation		13.4		
		29.5 dB attenuation		22.6		
Output Third Order Intercept Point	OIP3	0 dB attenuation Pout = +7 dBm / tone 5 MHz tone separation		38.5		dBm
		6 dB attenuation Pin = -21 dBm / tone 5 MHz tone separation		38.3		
		10 dB attenuation Pin = -21 dBm / tone 5 MHz tone separation	35	38		
		20 dB attenuation Pin = -21 dBm / tone 5 MHz tone separation		33.6		
		29.5 dB attenuation Pin = -21 dBm / tone 5 MHz tone separation		23		
Output 1dB Compression Point	OP1dB	0 dB attenuation		23.4		dBm
		0 dB attenuation, $T_{CASE} = +105\text{ }^{\circ}\text{C}$		22.8		
		6 dB attenuation	21.5	23.3		

- Items in min/max columns in **bold italics** are Guaranteed by Test.
- Items in min/max columns that are not bold/italics are Guaranteed by Design Characterization.
- Includes a positive slope feature over the noted RF range to compensate for typical system roll-off.

Thermal Characteristics

Table 6. Package Thermal Characteristics

Parameter	Symbol	Value	Units
Junction to Ambient Thermal Resistance.	θ_{JA}	40	$^{\circ}\text{C}/\text{W}$
Junction to Case Thermal Resistance. (Case is defined as the exposed paddle)	θ_{JC}	4	$^{\circ}\text{C}/\text{W}$
Moisture Sensitivity Rating (Per J-STD-020)		MSL 1	

Typical Operating Conditions (TOC)

Unless otherwise stated the typical operating graphs were measured under the following conditions:

- $V_{CC} = 5.0 \text{ V}$
- $Z_L = Z_S = 50 \text{ Ohms Single Ended}$
- $F_{RF} = 1.88 \text{ GHz}$
- $T_{CASE} = +25 \text{ }^{\circ}\text{C}$
- $/\text{STBY} = \text{High}$
- 5 MHz Tone Spacing
- Gain setting = Maximum Gain
- All temperatures are referenced to the exposed paddle
- ACLR measurements used with a Basic LTE FDD Downlink 20 MHz TM1.2 Test signal
- EVM measurements used with a Basic LTE FDD Downlink 20 MHz TM3.1 Test signal
- Note TN1: $\text{Atten} \leq 4 \text{ dB Fixed Pout} = 7 \text{ dBm per waveform or per tone}$, $\text{Atten} > 4 \text{ dB Fixed Pin} = -21 \text{ dBm per waveform or per tone}$
- Note TN2: $\text{Atten} \leq 7 \text{ dB Fixed Pout} = 10.5 \text{ dBm per waveform or per tone}$, $\text{Atten} > 7 \text{ dB Fixed Pin} = -14.5 \text{ dBm per waveform or per tone}$
- Evaluation Kit traces and connector losses are de-embedded

Typical Performance Characteristics

Figure 3. Maximum Gain vs. Freq over Temp and Voltage [Attn = 0.0 dB]

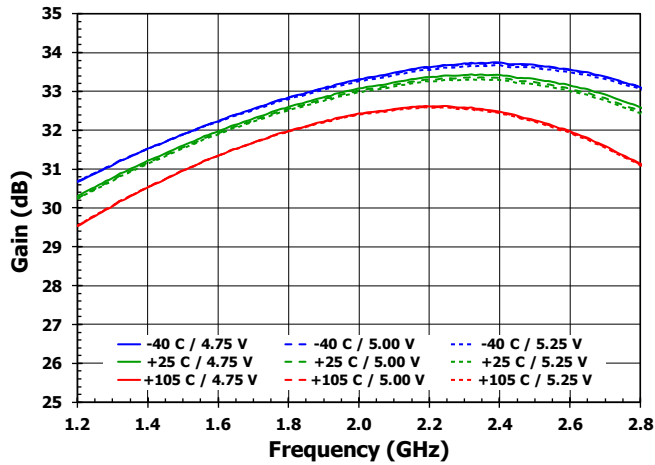

Figure 4. Reverse Isolation vs. Freq over Temp and Voltage [Attn = 0.0 dB]

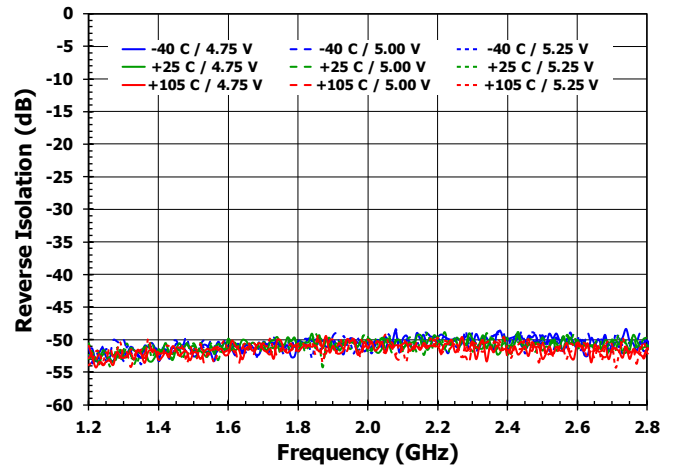

Figure 5. Input Return Loss vs. Freq over Temp and Voltage [Attn = 0.0 dB]

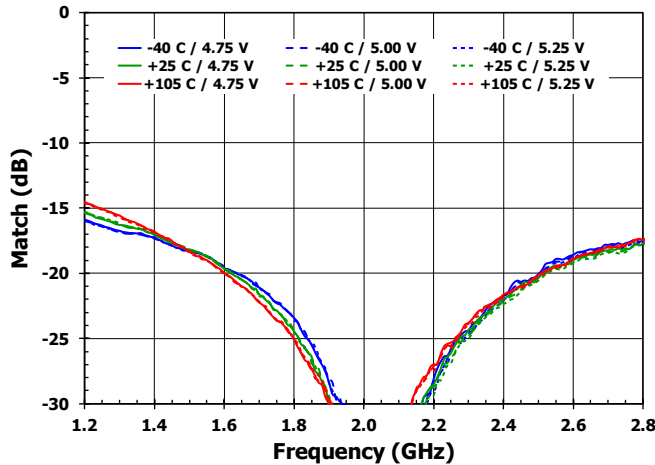

Figure 6. Output Return Loss vs. Freq over Temp. and Voltage [Attn = 0.0 dB]

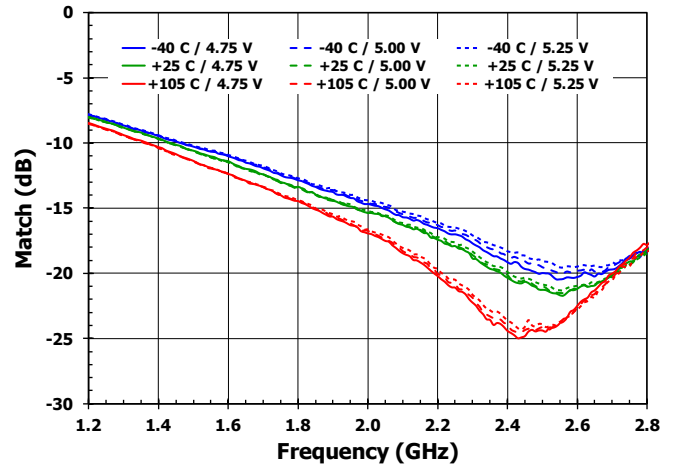

Figure 7. Stability vs. Freq over Temp and Voltage [Attn = 0.0 dB]

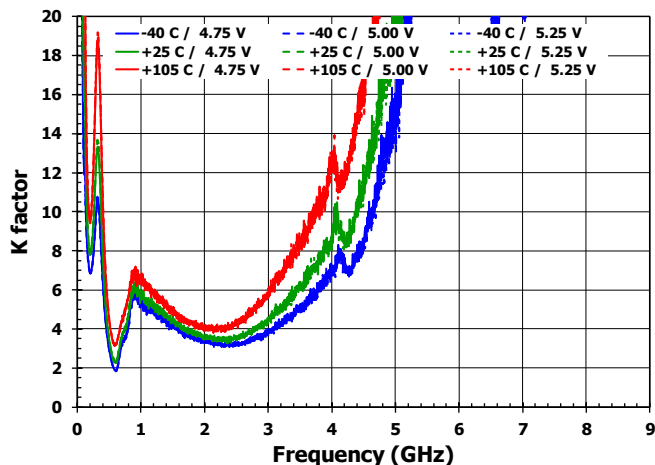
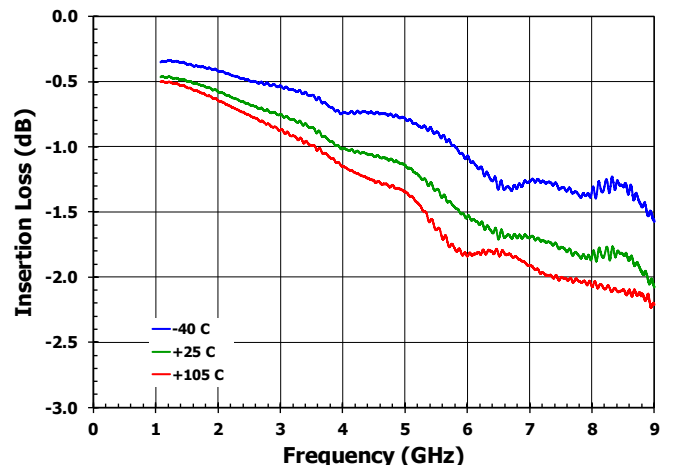

Figure 8. EvKit Insertion Loss vs. Freq over Temp



Typical Performance Characteristics

Figure 9. Gain vs. Freq [+25 °C, All States]

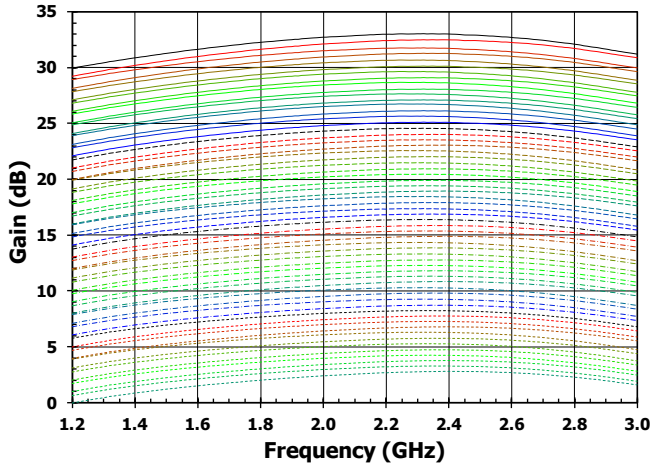

Figure 10. Gain vs. Atten over Temp and Voltage [1.88 GHz]

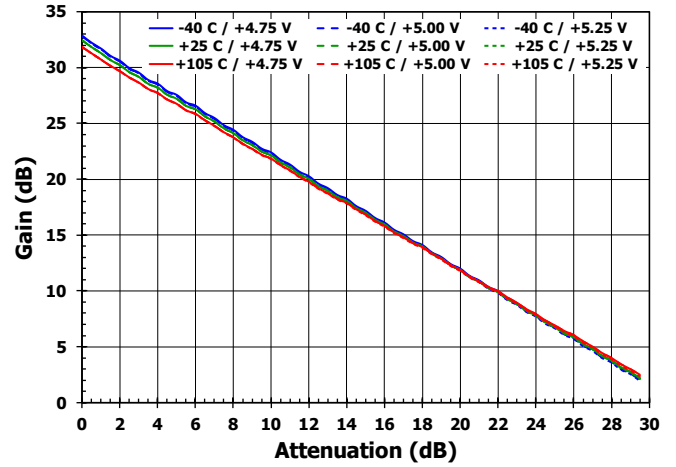

Figure 11. Worst Case Attenuator Absolute Accuracy vs. Freq [All parameters]

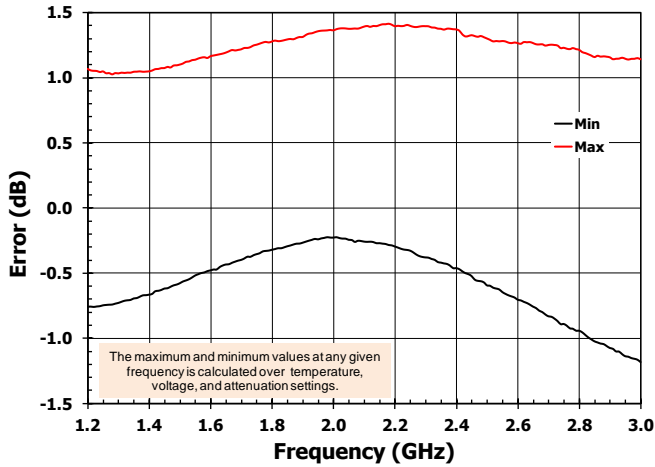

Figure 12. Attenuator Absolute Accuracy vs. Atten over Temp and Voltage [1.88 GHz]

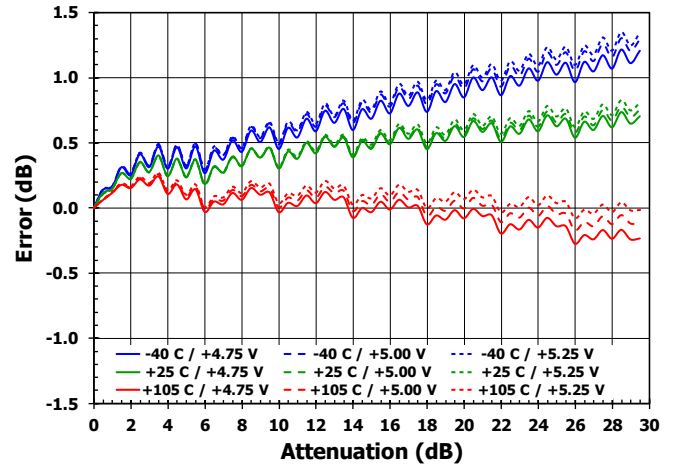

Figure 13. Worst Case Step Accuracy vs. Freq [All parameters]

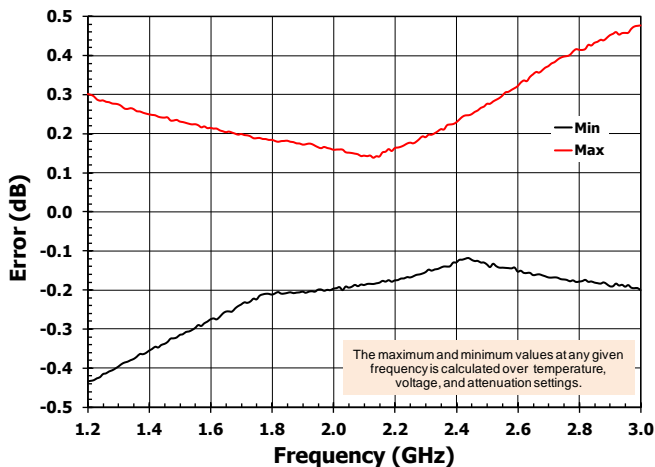
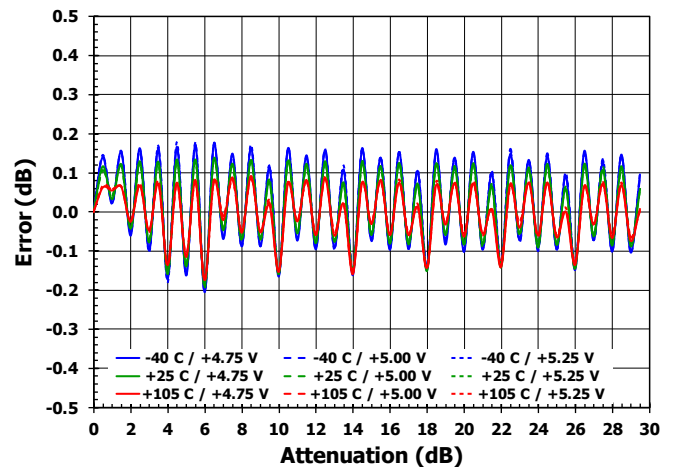

Figure 14. Step Accuracy vs. Atten over Temp and Voltage [1.88 GHz]



Typical Performance Characteristics

Figure 15. Input Return Loss vs. Freq [+25 °C, All states]

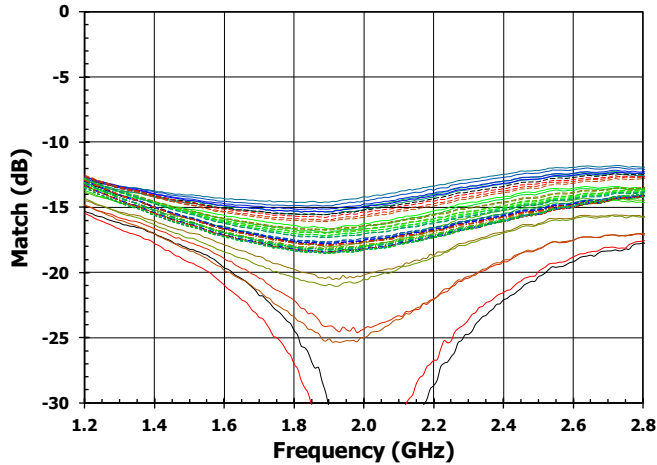

Figure 17. Output Return Loss vs. Freq [+25 °C, All states]

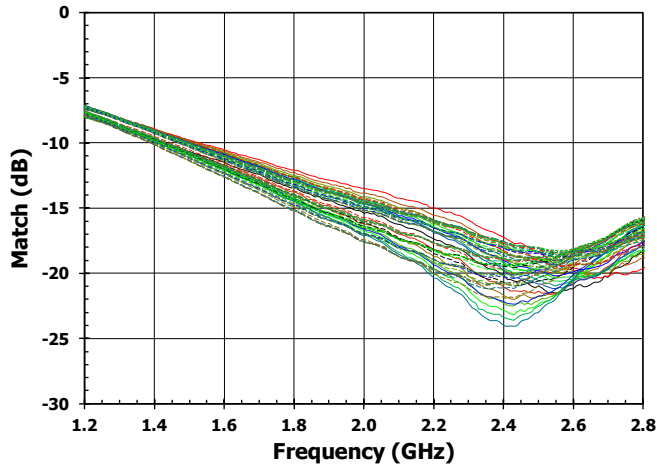

Figure 19. Reverse Isolation vs. Freq [+25 °C, All states]

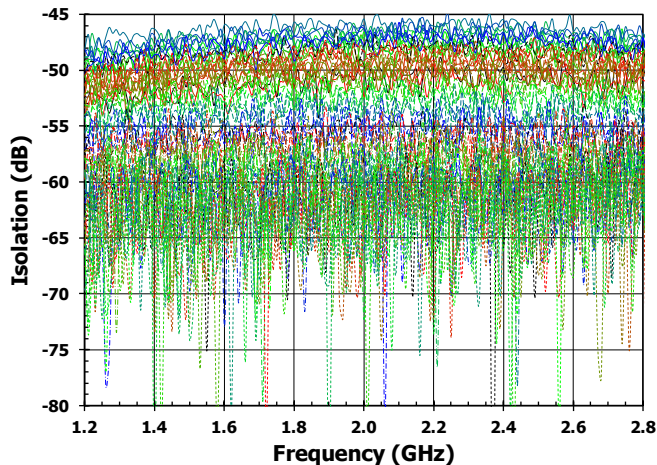

Figure 16. Input Return Loss vs. Atten over Temp and Voltage [1.88 GHz]

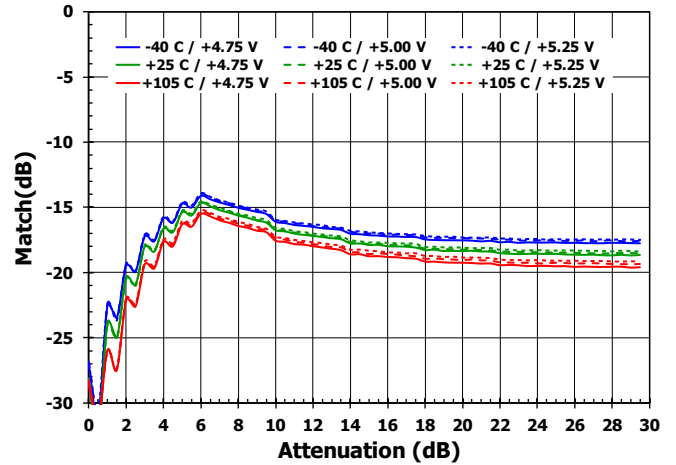

Figure 18. Output Return Loss vs. Atten over Temp and Voltage [1.88 GHz]

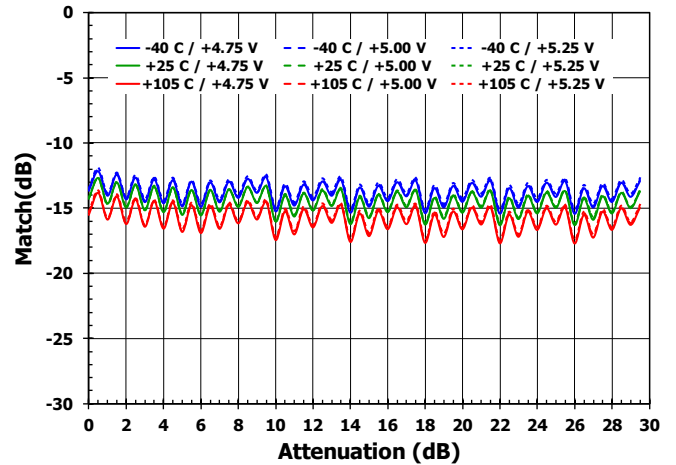
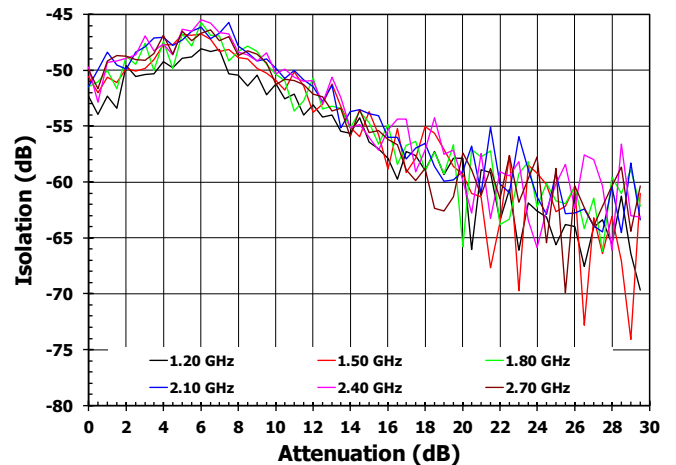

Figure 20. Reverse Isolation vs. Atten over Freq [+25 °C]



Typical Performance Characteristics

Figure 21. Output IP3 vs. Atten over Temp and Voltage [1.70 GHz]

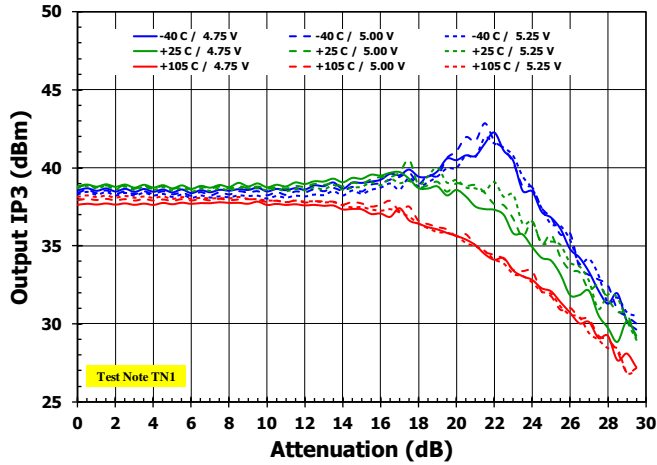

Figure 22. Output IP3 vs. Atten over Temp and Voltage [1.70 GHz]

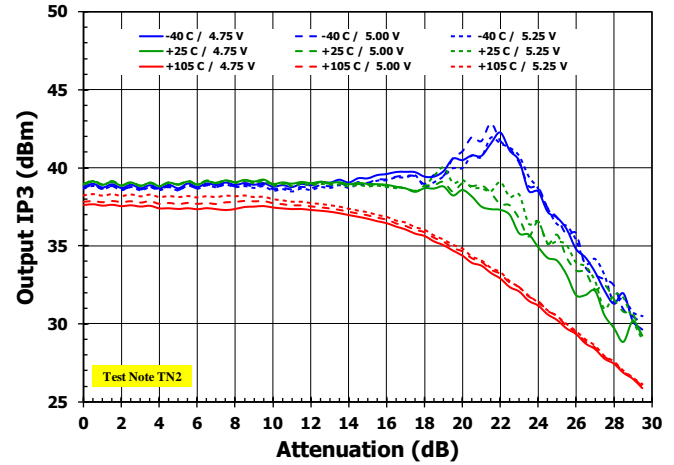

Figure 23. Output IP3 vs. Atten over Temp and Voltage [1.88 GHz]

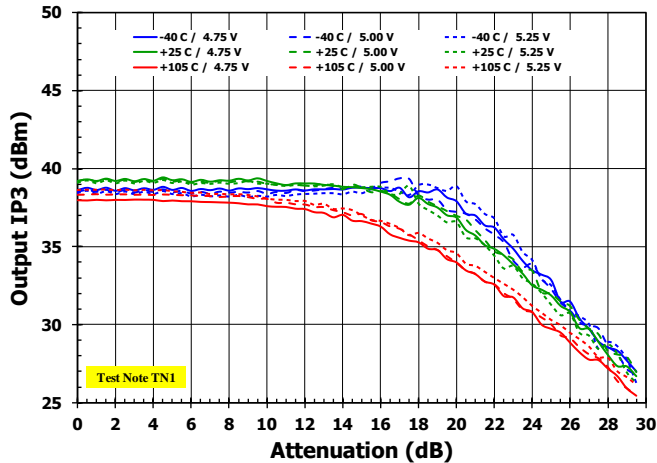

Figure 24. Output IP3 vs. Atten over Temp and Voltage [1.88 GHz]

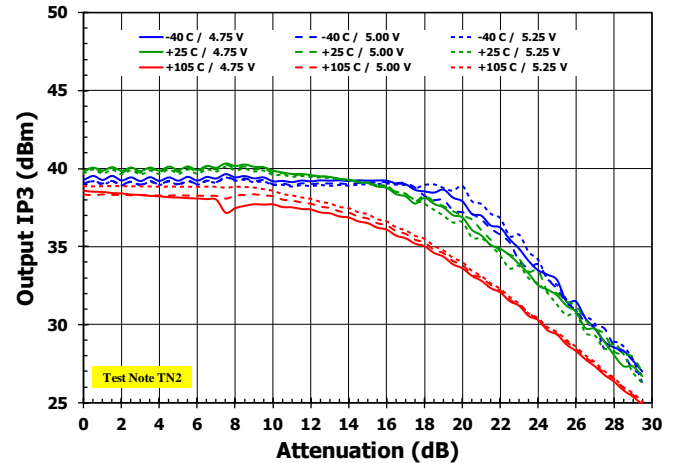

Figure 25. Output IP3 vs. Atten over Temp and Voltage [2.10 GHz]

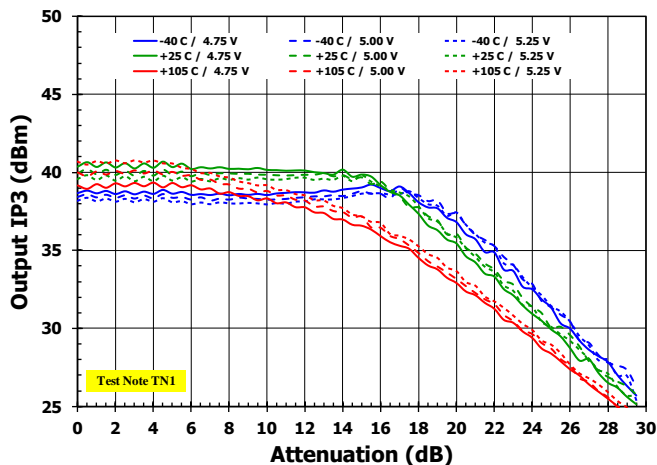
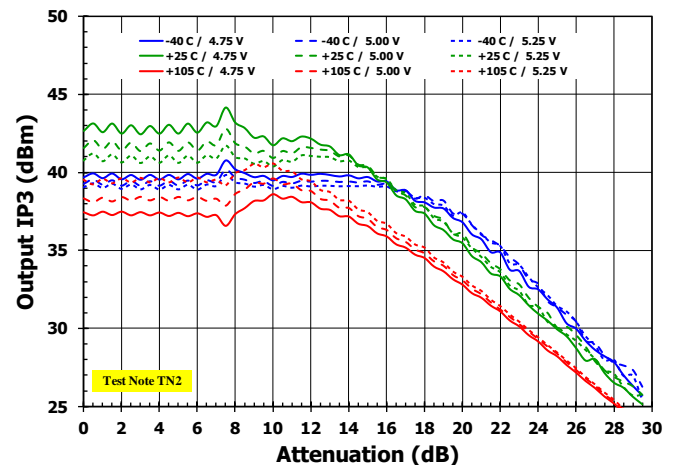

Figure 26. Output IP3 vs. Atten over Temp and Voltage [2.10 GHz]



Typical Performance Characteristics

Figure 27. Output IP3 vs. Freq over Temp and Voltage [Attn = 0.0 dB]

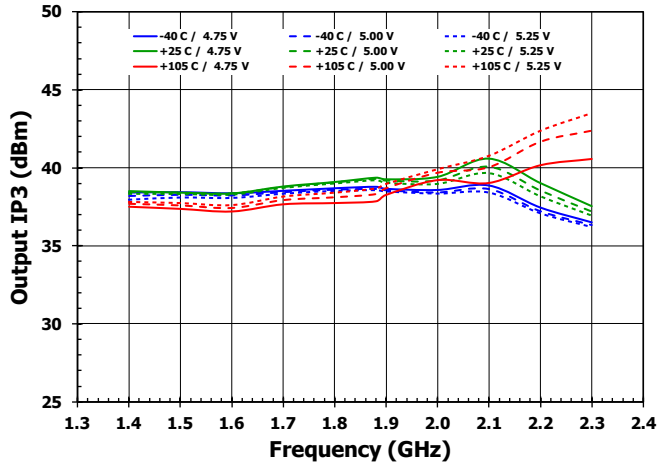

Figure 29. Output P1dB vs. Freq over Temp and Voltage [Attn = 0.0 dB]

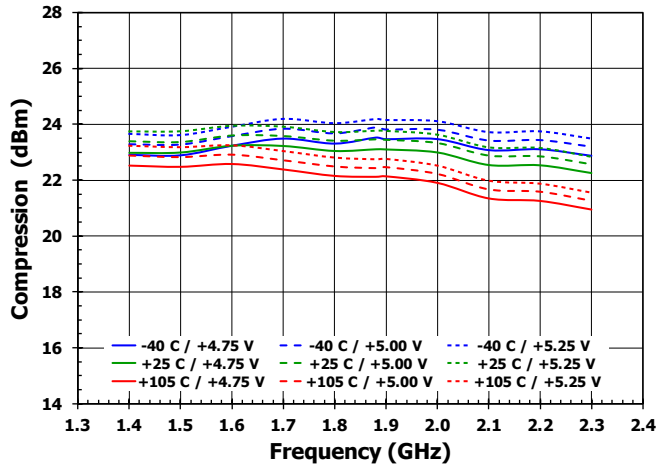

Figure 28. Output P1dB vs. Atten over Temp and Voltage [1.70 GHz]

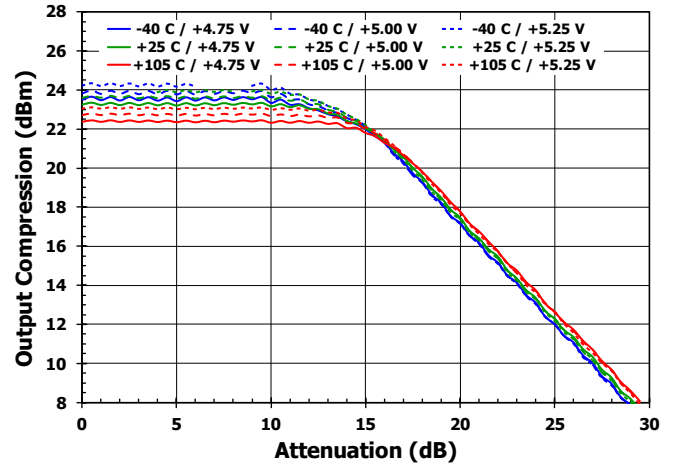

Figure 30. Output P1dB vs. Atten over Temp and Voltage [1.88 GHz]

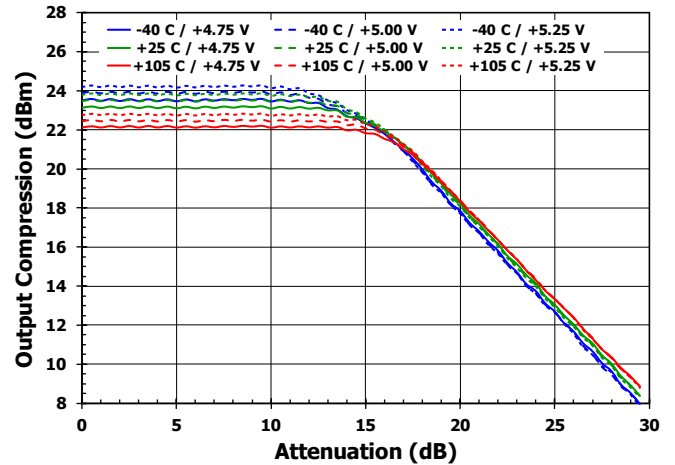
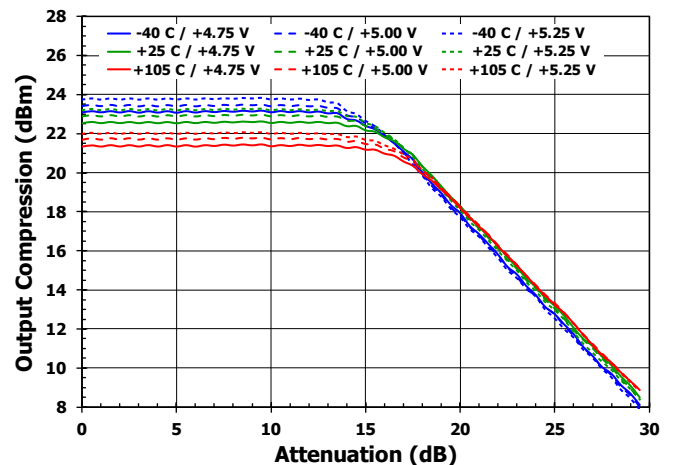

Figure 31. Output P1dB vs. Atten over Temp and Voltage [2.10 GHz]



Typical Performance Characteristics

Figure 32. Gain Compression vs. Pout over Temp and Voltage [1.70 GHz]

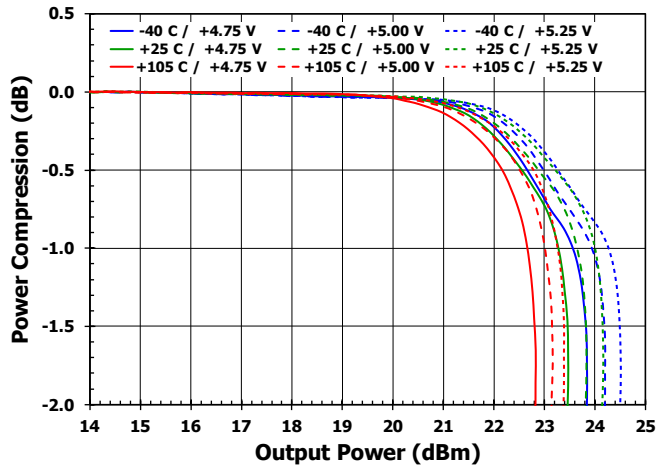

Figure 33. Phase Compression vs. Pout over Temp and Voltage [1.70 GHz]

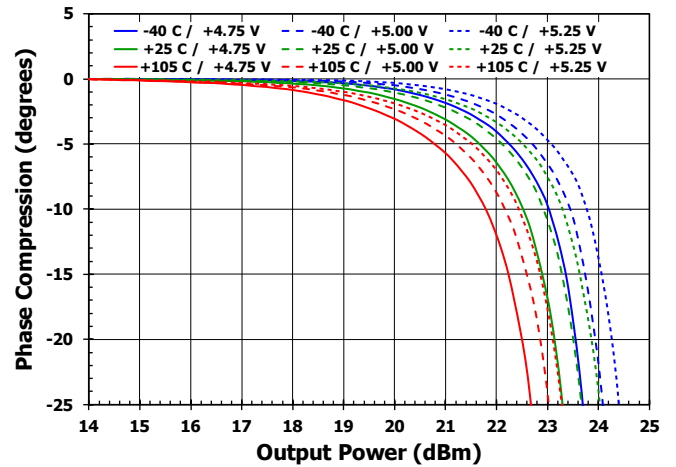

Figure 34. Gain Compression vs. Pout over Temp and Voltage [1.88 GHz]

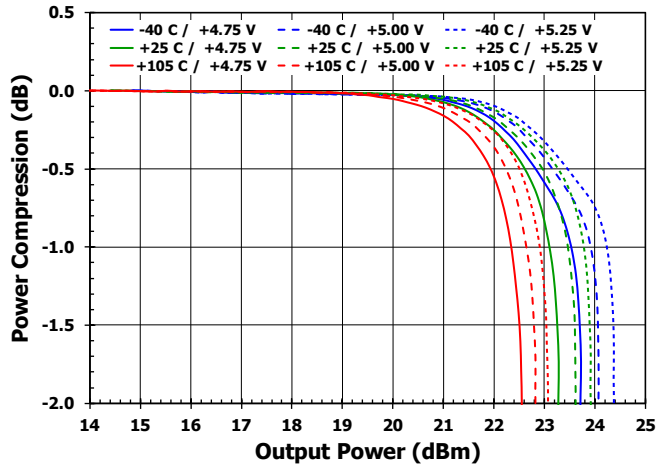

Figure 35. Phase Compression vs. Pout over Temp and Voltage [1.88 GHz]

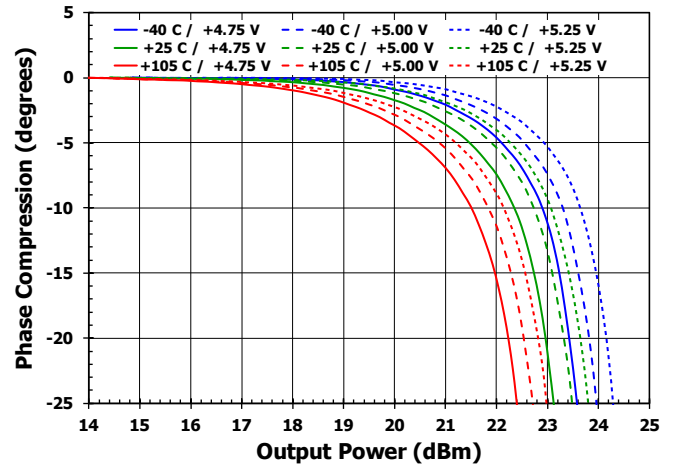

Figure 36. Gain Compression vs. Pout over Temp and Voltage [2.10 GHz]

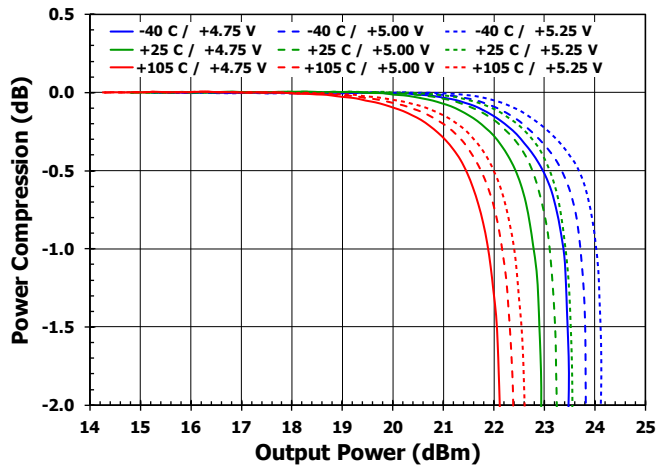
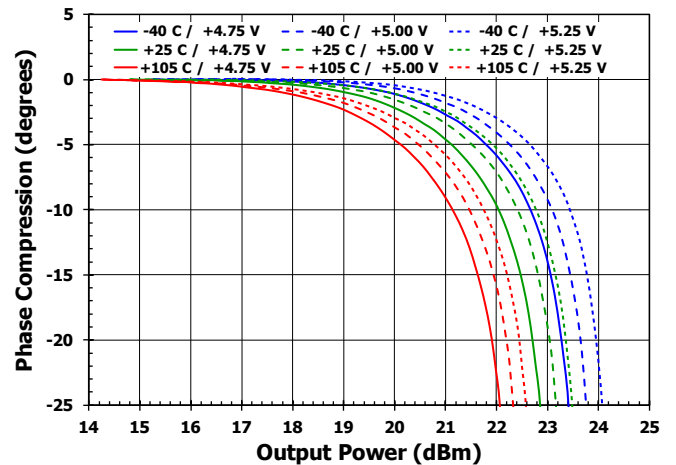

Figure 37. Phase Compression vs. Pout over Temp and Voltage [2.10 GHz]



Typical Performance Characteristics

Figure 38. Switching Speed 31.5 to 0.0 dB

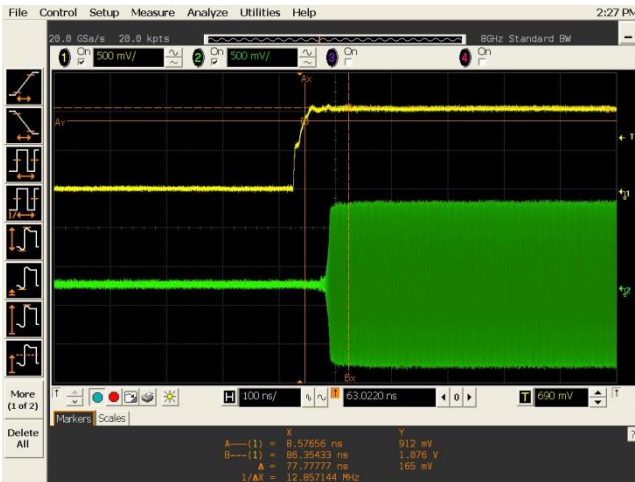

Figure 40. Standby Switching Off to On

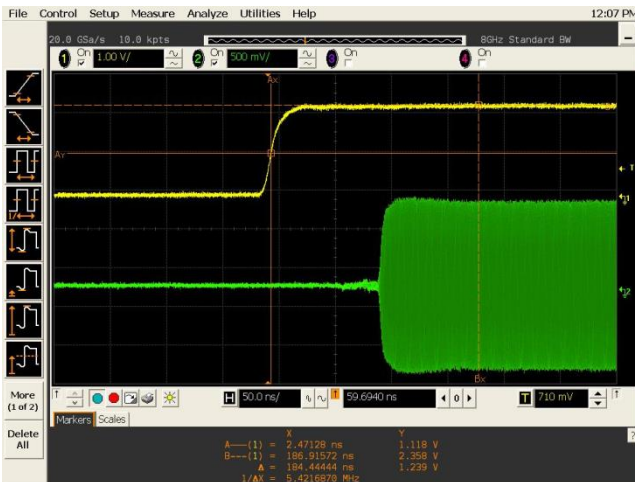

Figure 42. Noise Figure vs. Freq over Temp and Voltage [Attn = 0.0 dB]

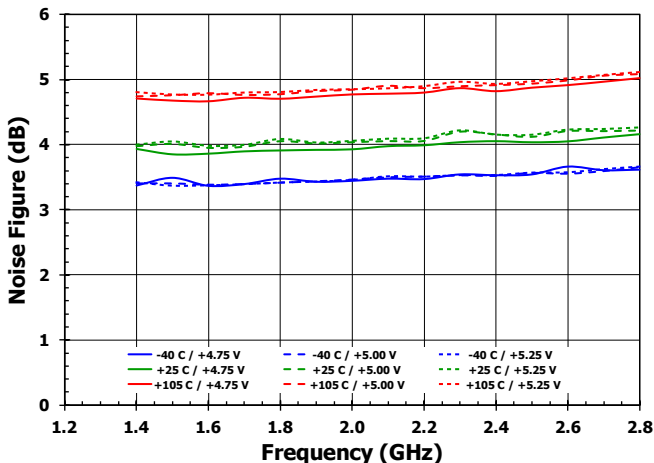

Figure 39. Noise Figure vs. Atten over Temp and Voltage [1.70 GHz]

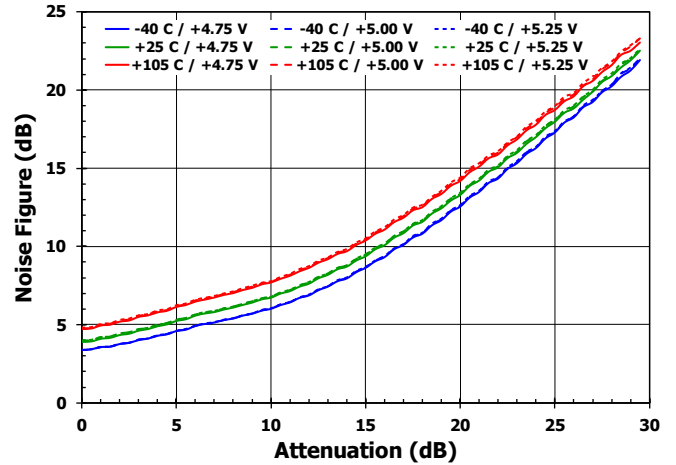

Figure 41. Noise Figure vs. Atten over Temp and Voltage [1.88 GHz]

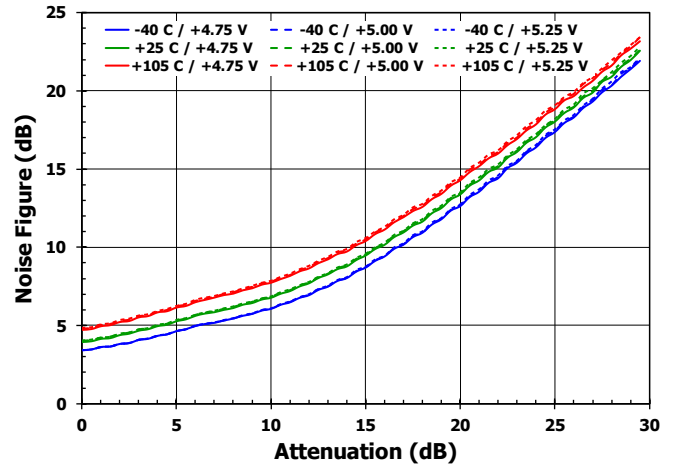
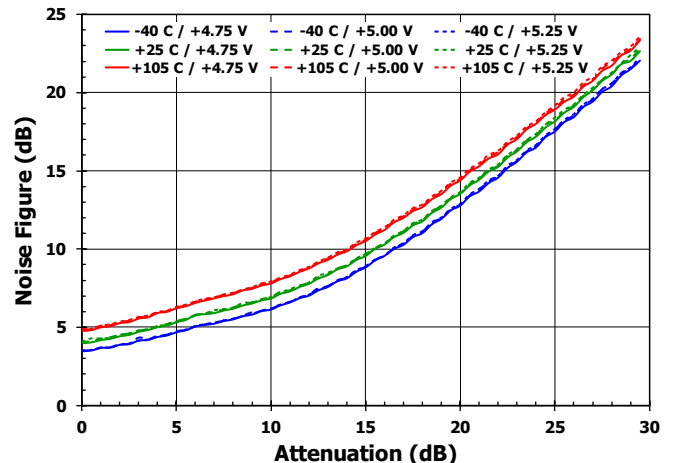
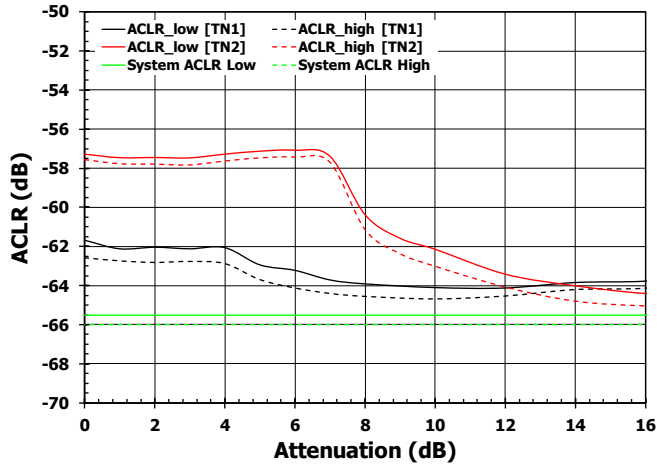
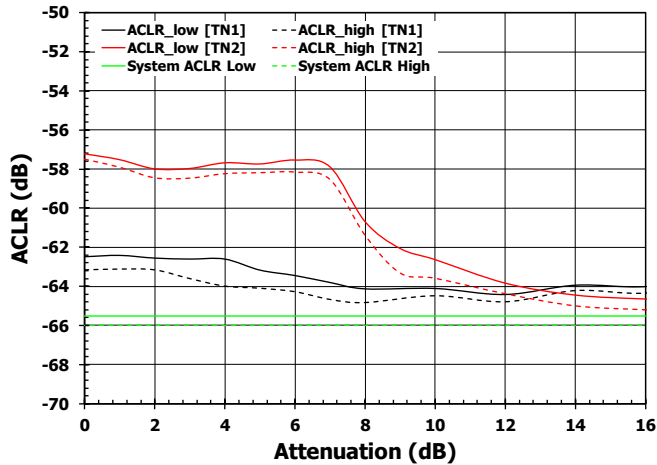
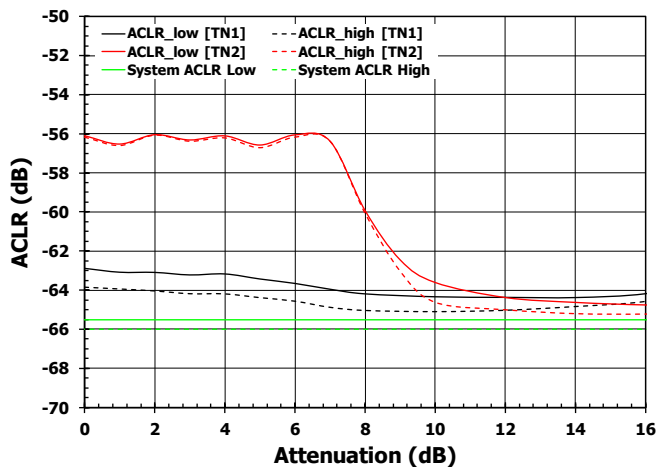
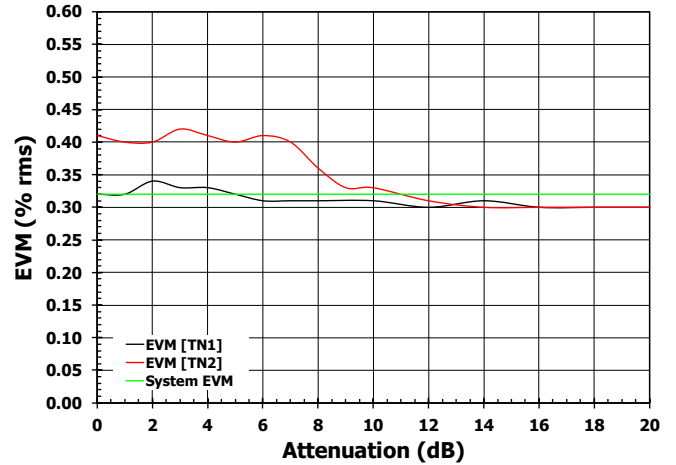
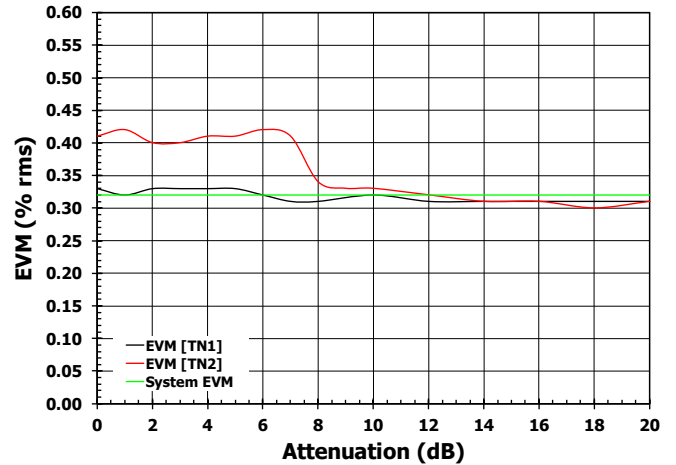
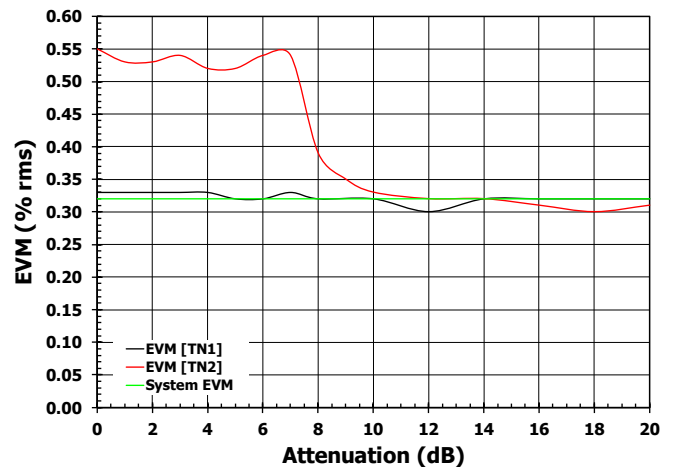

Figure 43. Noise Figure vs. Atten over Temp and Voltage [2.10 GHz]



Typical Performance Characteristics

Figure 44. ACLR vs. Atten [1.70 GHz]

Figure 46. ACLR vs. Atten [1.88 GHz]

Figure 48. ACLR vs. Atten [2.10 GHz]

Figure 45. EVM vs. Atten [1.70 GHz]

Figure 47. EVM vs. Atten [1.88 GHz]

Figure 49. EVM vs. Atten [2.10 GHz]

Serial Port Interface

Serial data is formatted as a 6-bit word clocking data in MSB first.

Table 7. Attenuation Word Truth Table

Control Bit						Attenuator Setting ^[a]
D5	D4	D3	D2	D1	D0	
1	1	1	1	1	1	0.0 dB
1	1	1	1	1	0	0.5 dB
1	1	1	1	0	1	1.0 dB
1	1	1	0	1	1	2.0 dB
1	1	0	1	1	1	4.0 dB
1	0	1	1	1	1	8.0 dB
0	1	1	1	1	1	16.0 dB
0	0	0	1	0	0	29.5 dB
0	0	0	0	1	1	29.5 dB
0	0	0	0	1	0	29.5 dB
0	0	0	0	0	1	29.5 dB
0	0	0	0	0	0	29.5 dB

a. The attenuation setting is designed to operate from 0 dB (111111) to 29.5 dB (000100).

Figure 50. Serial Register Timing Diagram

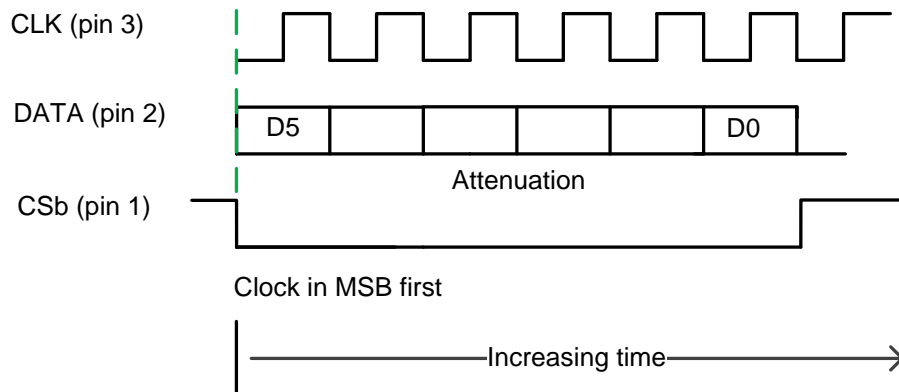
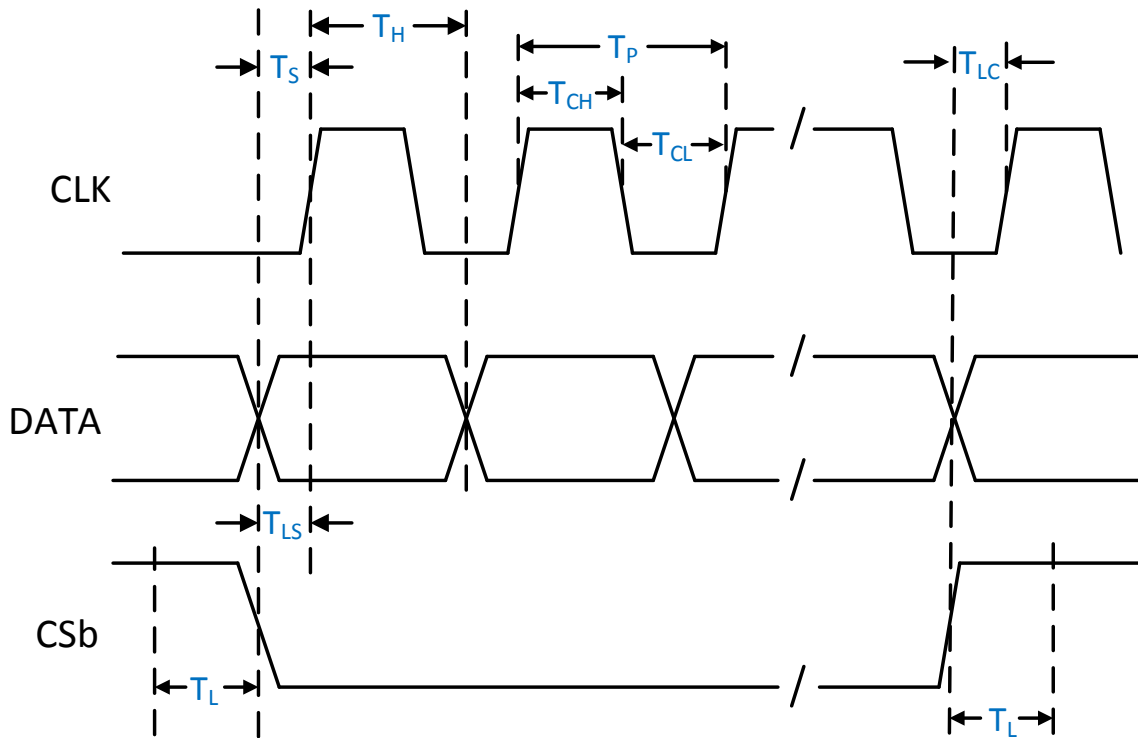

Figure 51. SPI Timing Diagram

Table 8. SPI Timing Diagram Values for Figure 51

Parameter	Symbol	Test Condition	Min	Typ	Max	Units
CLK Frequency	F_C				25	MHz
CLK High Duration Time	T_{CH}		20			ns
CLK Low Duration Time	T_{CL}		20			ns
DATA to CLK Setup Time	T_S		5			ns
CLK Period [a]	T_P		40			ns
CLK to DATA Hold Time	T_H		5			ns
CSb to CLK Setup Time	T_{LS}		5			ns
CSb Trigger Pulse Width	T_L		10			ns
CSb Trigger to CLK Setup Time [b]	T_{LC}		5			ns

a. $(T_{CH} + T_{CL}) \geq 1/F_C$
 b. Once all desired DATA is clocked in, T_{LC} represents the time a CSb high needs to occur before any subsequent CLK signals.

Table 9. Standby Truth Table

/STBY (pin 14)	Condition
0 V	Amplifier OFF with SPI powered ON
V_{CC}	Full operation

Application Information

The F1455 has been optimized for use in high performance RF applications from 1700 MHz to 2300 MHz. The device maintains good performance outside of the optimized band as shown by the Typical Performance Characteristics.

Power Up Attenuation Setting

When the part is initially powered up, the default VGA setting is the 29.5 dB [000000] attenuation state.

Chip Select (CSb)

When CSb is set to logic high, the CLK input is disabled. When CSb is set to logic low, the CLK input is enabled and the DATA word can be programmed into the shift registers. The programmed word is then latched into the F1455 on the CSb rising edge (refer to Figure 51). The operation of the SPI bus is independent of the /STBY pin setting (see Standby Mode section below).

Standby Mode (/STBY)

The F1455 has a power down feature for power savings. Connecting pin 14 to a logic high will enable the device. With a logic low applied to pin 14 or with pin 14 left open (internal 1 M Ω pull down to ground) the amplifier is placed in standby mode. The Standby mode is a high isolation state. The level of this isolation is not specified and is dependent on the device. In Standby mode the SPI bus is operational and the device attenuation setting can be programmed. Therefore, the device will present the desired attenuation when it is enabled.

Power Supplies

A common V_{CC} power supply should be used for all power supply pins. To minimize noise and fast transients de-coupling capacitors should be placed at all supply pins. Supply noise can degrade noise figure and fast transients can trigger ESD clamps causing them to fail. Supply voltage change or transients should have a slew rate smaller than 1 V / 20 μ s. In addition, all control pins should remain at 0 V (\pm 0.3 V) while the supply voltage ramps or while it returns to zero.

Control Pin Interface

If control signal integrity is a concern and clean signals cannot be guaranteed due to overshoot, undershoot, ringing, etc., the following circuit at the input of each control pin is recommended. This applies to SPI and control pins 1, 2, 3 and 14 as shown below. Note the recommended resistor and capacitor values do not necessarily match the EV kit BOM for the case of poor control signal integrity. For multiple devices driven by a single control line, the component values will need to be adjusted accordingly so as not to load down the control line.

Figure 52. Control Pin Interface for Signal Integrity

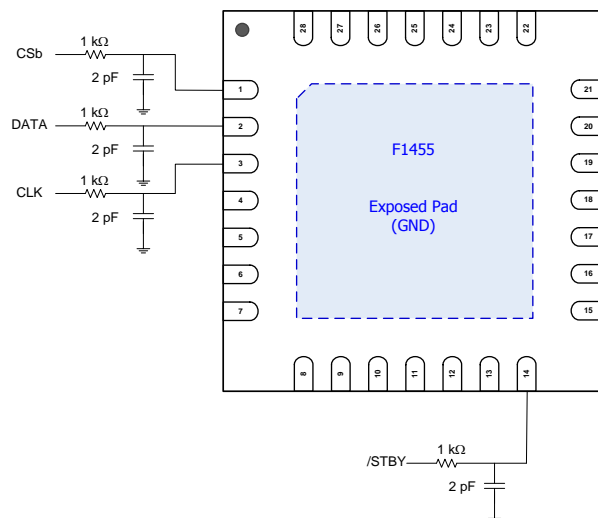

Evaluation Kit Picture

Figure 53. Top View

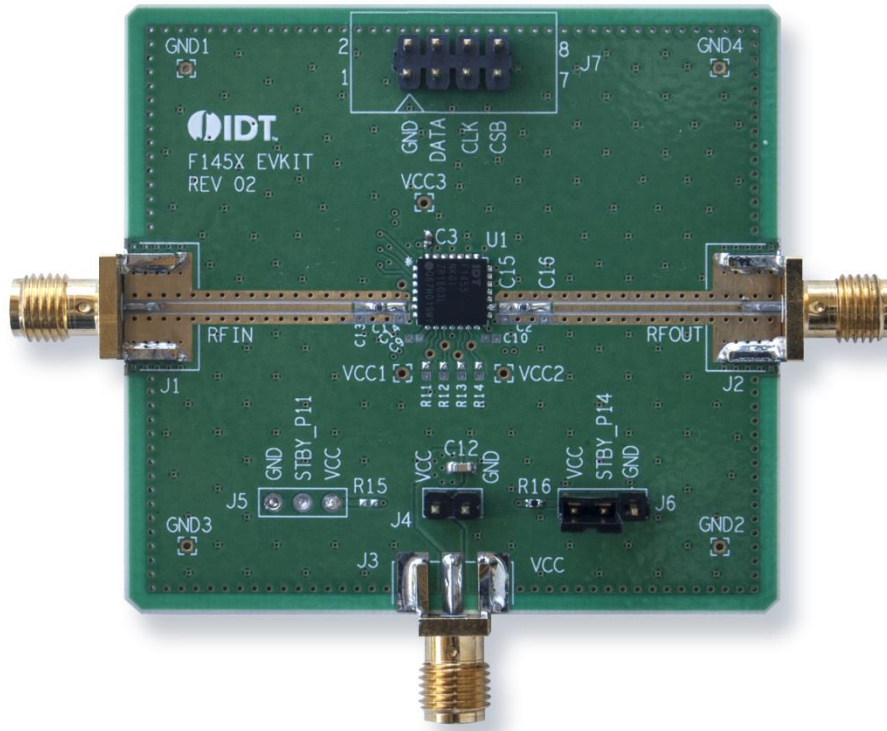
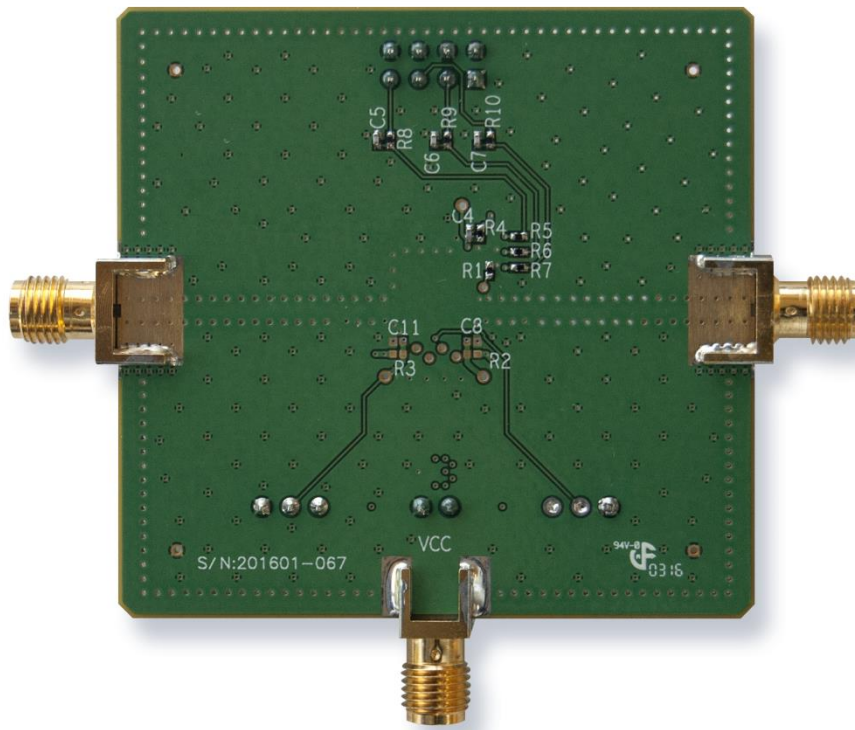
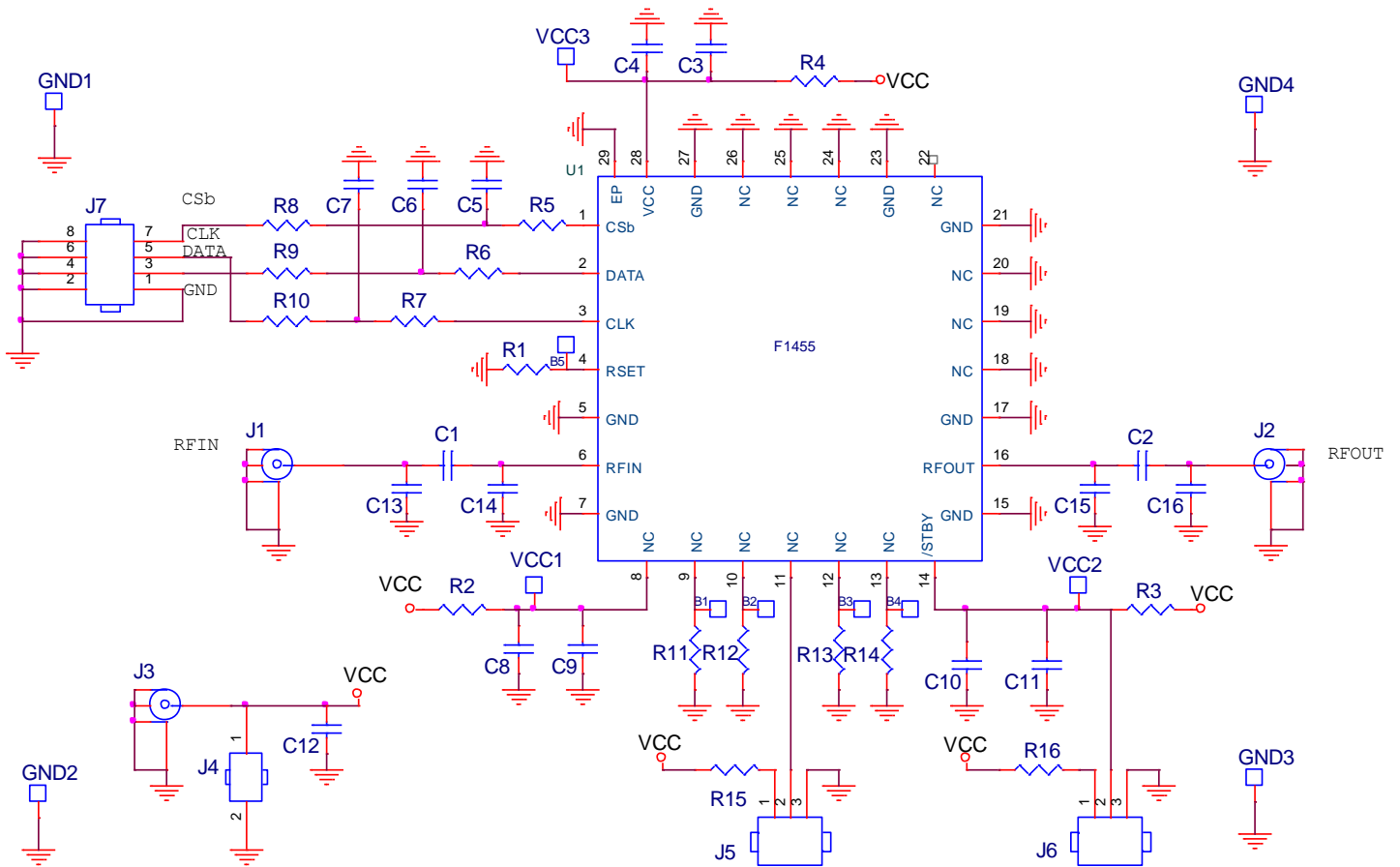

Figure 54. Bottom View



Evaluation Kit / Applications Circuit

Figure 55. Electrical Schematic



Not All Components are used. Please check the Bill of Material (BOM) table.

Table 10. Bill of Material (BOM)

Part Reference	QTY	Description	Manufacturer Part #	Manufacturer
C1, C2	2	22 pF \pm 5%, 50V, C0G Ceramic Capacitor (0402)	GRM1555C1H220J	MURATA
C3	1	100 nF \pm 10%, 16V, X7R Ceramic Capacitor (0402)	GRM155R71C104K	MURATA
C4	1	1000 pF \pm 5%, 50V, C0G Ceramic Capacitor (0402)	GRM1555C1H102J	MURATA
C5, C6, C7	3	2 pF \pm 0.1pF, 50V, C0G Ceramic Capacitor (0402)	GRM1555C1H2R0B	MURATA
C12	1	10 uF \pm 20%, 16V, X6S Ceramic Capacitor (0603)	GRM188C81C106M	MURATA
R1	1	1.74 k Ω \pm 1%, 1/10W, Resistor (0402)	ERJ-2RKF1741X	PANASONIC
R4 - R7	4	0 Ω Resistors (0402)	ERJ-2GE0R00X	PANASONIC
R8 - R10, R16	4	1 k Ω \pm 1%, 1/10W, Resistor (0402)	ERJ-2RKF1001X	PANASONIC
J4	1	CONN HEADER VERT SGL 2 X 1 POS GOLD	961102-6404-AR	3M
J6	1	CONN HEADER VERT SGL 3 X 1 POS GOLD	961103-6404-AR	3M
J7	1	CONN HEADER VERT DBL 4 X 2 POS GOLD	67997-108HLF	FCI
J1, J2	2	Edge Launch SMA (0.375 inch pitch ground, tab)	142-0701-851	Emerson Johnson
J3	1	Edge Launch SMA (0.250 inch pitch ground, round)	142-0711-821	Emerson Johnson
U1	1	VGA AMP	F1455NKGI	IDT
C8 - C11, C13 - C16, R2, R3, R11 - R15, J5		DNP (Do Not Populate)		
	1	Printed Circuit Board	F145X EVKIT REV 02	

Evaluation Kit Operation

Standby

Connector J6 allows the F1455 to be put into the standby mode (STBY). Making no connection or connecting J6 pin 2 (the center pin) to V_{cc} the amplifier will be placed in normal operating mode. To put the F1455 into standby mode for very low power consumption ground J6 pin 2 (the center pin).

Figure 56. Image of J6 connector for Standby mode control

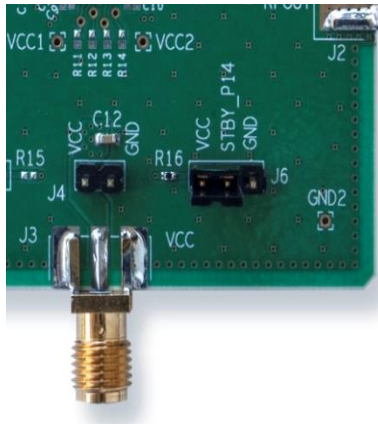

Serial Programming Pins

Connector J7 pins 1, 2, 4, 6, 8 are ground. Pin 3 is DATA, pin 5 is Clock (CLK), pin 7 is Chip Select (CSB).

Figure 57. Image of J7 connector for SPI

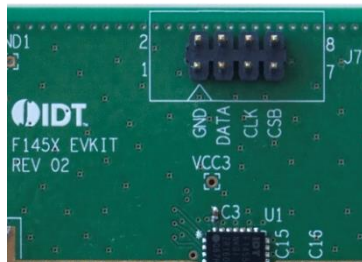

Package Drawings

Figure 58. Package Outline Drawing NKG28 PSC-4606

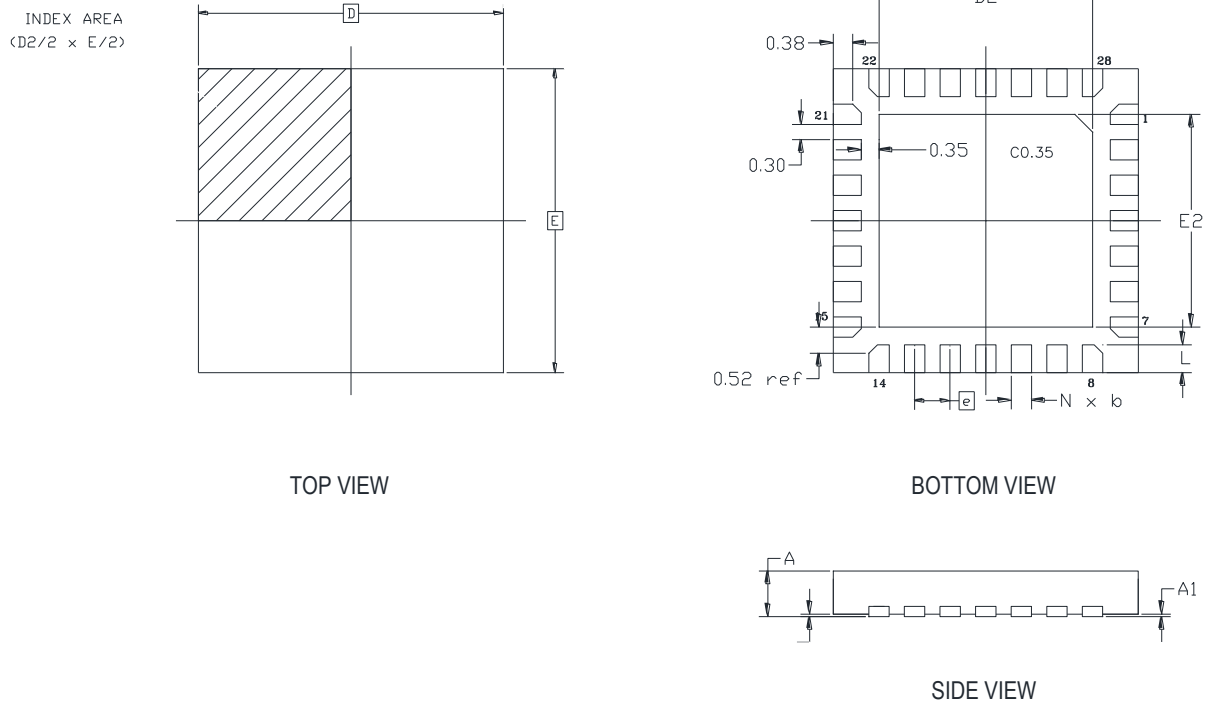

SYMBOL	DIMENSION		
	MIN	NOM	MAX
D2	4.10	4.20	4.30
E2	4.10	4.20	4.30
L	0.45	0.55	0.65
D	6.00 BSC		
E	6.00 BSC		
e	0.70 BSC		
A	0.80	0.90	1.00
A1	0.00	0.02	0.05
b	0.35	0.40	0.45
N	28		
aaa	0.15		
bbb	0.10		
ccc	0.10		
ddd	0.05		
eee	0.08		
fff	0.10		

NOTES:

1. ALL DIMENSIONING AND TOLERANCING CONFORM TO ANSI Y14.5M-1982
2. ALL DIMENSIONS ARE IN MILLIMETERS.

Ordering Information

Orderable Part Number	Package	MSL Rating	Shipping Packaging	Temperature
F1455NKGK	6 x 6 x 0.9 mm QFN	1	Tray	-40° to +105°C
F1455NKGK8	6 x 6 x 0.9 mm QFN	1	Tape and Reel	-40° to +105°C
F1455EVBK	Evaluation Board			
F1455EVSK	Evaluation Solution			

Marking Diagram

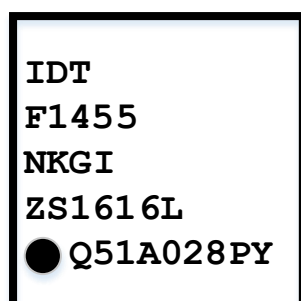

1. Line 2 and 3 are the part number.
2. Line 4 "ZS" Assembly Stepping.
3. Line 4 "yyww = 1616" is has two digits for the year and week that the part was assembled.
4. Line 4 "L" denotes Assembly Site.
5. Line 5 "Q51A028PY" is the Assembly Lot number

Revision History

Revision Date	Description of Change
2016 - July - 08	Initial Release
2016 - October - 18	Updated Step Error specification. Other minor formatting changes.

**Corporate Headquarters**

6024 Silver Creek Valley Road
San Jose, CA 95138
www.IDT.com

Sales

1-800-345-7015 or 408-284-8200
Fax: 408-284-2775
www.IDT.com/go/sales

Tech Support

www.IDT.com/go/support

DISCLAIMER Integrated Device Technology, Inc. (IDT) reserves the right to modify the products and/or specifications described herein at any time, without notice, at IDT's sole discretion. Performance specifications and operating parameters of the described products are determined in an independent state and are not guaranteed to perform the same way when installed in customer products. The information contained herein is provided without representation or warranty of any kind, whether express or implied, including, but not limited to, the suitability of IDT's products for any particular purpose, an implied warranty of merchantability, or non-infringement of the intellectual property rights of others. This document is presented only as a guide and does not convey any license under intellectual property rights of IDT or any third parties.

IDT's products are not intended for use in applications involving extreme environmental conditions or in life support systems or similar devices where the failure or malfunction of an IDT product can be reasonably expected to significantly affect the health or safety of users. Anyone using an IDT product in such a manner does so at their own risk, absent an express, written agreement by IDT.

Integrated Device Technology, IDT and the IDT logo are trademarks or registered trademarks of IDT and its subsidiaries in the United States and other countries. Other trademarks used herein are the property of IDT or their respective third party owners. For datasheet type definitions and a glossary of common terms, visit www.idt.com/go/glossary. All contents of this document are copyright of Integrated Device Technology, Inc. All rights reserved

Компания «Life Electronics» занимается поставками электронных компонентов импортного и отечественного производства от производителей и со складов крупных дистрибьюторов Европы, Америки и Азии.

С конца 2013 года компания активно расширяет линейку поставок компонентов по направлению коаксиальный кабель, кварцевые генераторы и конденсаторы (керамические, пленочные, электролитические), за счёт заключения дистрибьюторских договоров

Мы предлагаем:

- Конкурентоспособные цены и скидки постоянным клиентам.
- Специальные условия для постоянных клиентов.
- Подбор аналогов.
- Поставку компонентов в любых объемах, удовлетворяющих вашим потребностям.
- Приемлемые сроки поставки, возможна ускоренная поставка.
- Доставку товара в любую точку России и стран СНГ.
- Комплексную поставку.
- Работу по проектам и поставку образцов.
- Формирование склада под заказчика.
- Сертификаты соответствия на поставляемую продукцию (по желанию клиента).
- Тестирование поставляемой продукции.
- Поставку компонентов, требующих военную и космическую приемку.
- Входной контроль качества.
- Наличие сертификата ISO.

В составе нашей компании организован Конструкторский отдел, призванный помогать разработчикам, и инженерам.

Конструкторский отдел помогает осуществить:

- Регистрацию проекта у производителя компонентов.
- Техническую поддержку проекта.
- Защиту от снятия компонента с производства.
- Оценку стоимости проекта по компонентам.
- Изготовление тестовой платы монтаж и пусконаладочные работы.



Тел: +7 (812) 336 43 04 (многоканальный)

Email: org@lifeelectronics.ru