



### FEATURES

- Low power: 330  $\mu\text{A}$  maximum quiescent current
- Rail-to-rail output
- Low noise and distortion
  - 8  $\text{nV}/\sqrt{\text{Hz}}$  maximum input voltage noise at 1 kHz
  - 0.15  $\mu\text{V}$  p-p RTI noise ( $G = 100$ )
  - 0.5 ppm nonlinearity with 2 k $\Omega$  load ( $G = 1$ )
- Excellent ac specifications
  - 80 dB minimum CMRR at 10 kHz ( $G = 1$ )
  - 2.2 MHz bandwidth ( $G = 1$ )
- High precision dc performance ([AD8422BRZ](#))
  - 150 dB minimum CMRR ( $G = 1000$ )
  - 0.04% maximum gain error ( $G = 1000$ )
  - 0.3  $\mu\text{V}/^\circ\text{C}$  maximum input offset drift
  - 0.5 nA maximum input bias current
- Wide supply range
  - 4.6 V to 36 V single supply
  - $\pm 2.3$  V to  $\pm 18$  V dual supply
- Input overvoltage protection: 40 V from opposite supply
- Gain range: 1 to 1000

### APPLICATIONS

- Medical instrumentation
- Industrial process controls
- Strain gages
- Transducer interfaces
- Precision data acquisition systems
- Channel-isolated systems
- Portable instrumentation

### GENERAL DESCRIPTION

The [AD8422](#) is a high precision, low power, low noise, rail-to-rail instrumentation amplifier that delivers the best performance per unit microampere in the industry. The [AD8422](#) processes signals with ultralow distortion performance that is load independent over its full output range.

The [AD8422](#) is the third generation development of the industry-standard [AD620](#). The [AD8422](#) employs new process technologies and design techniques to achieve higher dynamic range and lower errors than its predecessors, while consuming less than one-third of the power. The [AD8422](#) uses the high performance pinout introduced by the [AD8221](#).

Very low bias current makes the [AD8422](#) error-free with high source impedance, allowing multiple sensors to be multiplexed to the inputs. Low voltage noise and low current noise make the [AD8422](#) an ideal choice for measuring a Wheatstone bridge.

Rev. A

[Document Feedback](#)

Information furnished by Analog Devices is believed to be accurate and reliable. However, no responsibility is assumed by Analog Devices for its use, nor for any infringements of patents or other rights of third parties that may result from its use. Specifications subject to change without notice. No license is granted by implication or otherwise under any patent or patent rights of Analog Devices. Trademarks and registered trademarks are the property of their respective owners.

### CONNECTION DIAGRAM



Figure 1. 8-Lead MSOP (RM), 8-Lead SOIC (R)



Figure 2. Total Harmonic Distortion vs. Frequency

The wide input range and rail-to-rail output of the [AD8422](#) bring all of the benefits of a high performance in-amp to single-supply applications. Whether using high or low supply voltages, the power savings make the [AD8422](#) an excellent choice for high channel count or power sensitive applications on a very tight error budget.

The [AD8422](#) uses robust input protection that ensures reliability without sacrificing noise performance. The [AD8422](#) has high ESD immunity, and the inputs are protected from continuous voltages up to 40 V from the opposite supply rail.

A single resistor sets the gain from 1 to 1000. The reference pin can be used to apply a precise offset to the output voltage.

The [AD8422](#) is specified from  $-40^\circ\text{C}$  to  $+85^\circ\text{C}$  and has typical performance curves to  $125^\circ\text{C}$ . It is available in 8-lead MSOP and 8-lead SOIC packages.

## TABLE OF CONTENTS

|  |    |   |    |
|--|----|---|----|
| Features .....                                   | 1  | Architecture .....                          | 19 |
| Applications.....                                | 1  | Gain Selection.....                         | 19 |
| Connection Diagram .....                         | 1  | Reference Terminal .....                    | 20 |
| General Description .....                        | 1  | Input Voltage Range.....                    | 20 |
| Revision History .....                           | 2  | Layout .....                                | 20 |
| Specifications.....                              | 3  | Input Bias Current Return Path .....        | 21 |
| SOIC Package.....                                | 3  | Input Voltages Beyond the Supply Rails..... | 21 |
| MSOP Package.....                                | 5  | Radio Frequency Interference (RFI).....     | 22 |
| Absolute Maximum Ratings.....                    | 8  | Applications Information .....              | 23 |
| Thermal Resistance .....                         | 8  | Precision Bridge Conditioning.....          | 23 |
| ESD Caution.....                                 | 8  | Process Control Analog Input .....          | 23 |
| Pin Configuration and Function Descriptions..... | 9  | Outline Dimensions .....                    | 24 |
| Typical Performance Characteristics .....        | 10 | Ordering Guide .....                        | 24 |
| Theory of Operation .....                        | 19 |   |    |

## REVISION HISTORY

### 1/15—Rev. 0 to Rev. A

|  |    |
|--|----|
| Changes to Features Section.....                                       | 1  |
| Changes to SOIC Package Section and Table 1 .....                      | 4  |
| Changes to MSOP Package Section and Table 2 .....                      | 5  |
| Changes to Supply Voltage Parameter and<br>ESD Parameter, Table 3..... | 8  |
| Deleted Figure 12 and Figure 15, Renumbered Sequentially ...           | 11 |
| Changes to Figure 10 to Figure 15.....                                 | 11 |
| Changes to Figure 16, Figure 18, and Figure 19 .....                   | 12 |
| Changes to Figure 23 and Figure 24.....                                | 13 |
| Changes to Figure 31, Figure 32, and Figure 33 .....                   | 14 |
| Changes to Figure 64.....  | 23 |

### 5/13—Revision 0: Initial Version

## SPECIFICATIONS

## SOIC PACKAGE

$V_S = \pm 15\text{ V}$ ,  $V_{REF} = 0\text{ V}$ ,  $V_{+IN} = 0\text{ V}$ ,  $V_{-IN} = 0\text{ V}$ ,  $T_A = 25^\circ\text{C}$ ,  $G = 1$ ,  $R_L = 2\text{ k}\Omega$ , unless otherwise noted.

Table 1.

| Parameter  | Test Conditions/<br>Comments                 | AD8422ARZ |      |     | AD8422BRZ |      |      | Unit                         |
|--|--|-----------|------|-----|-----------|------|------|------------------------------|
|  |  | Min       | Typ  | Max | Min       | Typ  | Max  |                              |
| COMMON-MODE REJECTION RATIO                            |  |           |      |     |           |      |      |                              |
| CMRR DC to 60 Hz with 1 k $\Omega$<br>Source Imbalance | $V_{CM} = -10\text{ V to }+10\text{ V}$      |           |      |     |           |      |      |                              |
| G = 1  |  | 86        |      |     | 94        |      |      | dB                           |
| G = 10   |  | 106       |      |     | 114       |      |      | dB                           |
| G = 100  |  | 126       |      |     | 134       |      |      | dB                           |
| G = 1000   |  | 146       |      |     | 150       |      |      | dB                           |
| Over Temperature, G=1                                  | $T = -40^\circ\text{C to }+85^\circ\text{C}$ | 83        |      |     | 89        |      |      | dB                           |
| CMRR at 10 kHz   | $V_{CM} = -10\text{ V to }+10\text{ V}$      |           |      |     |           |      |      |                              |
| G = 1  |  | 80        |      |     | 80        |      |      | dB                           |
| G = 10   |  | 90        |      |     | 95        |      |      | dB                           |
| G = 100  |  | 100       |      |     | 100       |      |      | dB                           |
| G = 1000   |  | 100       |      |     | 100       |      |      | dB                           |
| NOISE <sup>1</sup>                                     |  |           |      |     |           |      |      |                              |
| Voltage Noise, 1 kHz                                   |  |           |      |     |           |      |      |                              |
| Input Voltage Noise, $e_{NI}$                          | $V_{IN+}, V_{IN-}, V_{REF} = 0\text{ V}$     |           |      | 8   |           |      | 8    | nV/ $\sqrt{\text{Hz}}$       |
| Output Voltage Noise, $e_{NO}$                         |  |           |      | 80  |           |      | 80   | nV/ $\sqrt{\text{Hz}}$       |
| Peak to Peak, RTI                                      | $f = 0.1\text{ Hz to }10\text{ Hz}$          |           |      |     |           |      |      |                              |
| G = 1  |  |           | 2    |     |           | 2    |      | $\mu\text{V p-p}$            |
| G = 10   |  |           | 0.5  |     |           | 0.5  |      | $\mu\text{V p-p}$            |
| G = 100 to 1000  |  |           | 0.15 |     |           | 0.15 |      | $\mu\text{V p-p}$            |
| Current Noise  | $f = 1\text{ kHz}$                           |           | 90   |     |           | 90   | 110  | fA/ $\sqrt{\text{Hz}}$       |
|  | $f = 0.1\text{ Hz to }10\text{ Hz}$          |           | 8    |     |           | 8    |      | pA p-p                       |
| VOLTAGE OFFSET <sup>2</sup>                            |  |           |      |     |           |      |      |                              |
| Input Offset, $V_{OSI}$                                | $V_S = \pm 2.3\text{ V to } \pm 15\text{ V}$ |           |      | 60  |           |      | 25   | $\mu\text{V}$                |
| Over Temperature                                       | $T = -40^\circ\text{C to }+85^\circ\text{C}$ |           |      | 70  |           |      | 40   | $\mu\text{V}$                |
| Average Temperature<br>Coefficient                     |  |           |      | 0.4 |           |      | 0.3  | $\mu\text{V}/^\circ\text{C}$ |
| Output Offset, $V_{OSO}$                               | $V_S = \pm 2.3\text{ V to } \pm 15\text{ V}$ |           |      | 300 |           |      | 150  | $\mu\text{V}$                |
| Over Temperature                                       | $T = -40^\circ\text{C to }+85^\circ\text{C}$ |           |      | 500 |           |      | 300  | $\mu\text{V}$                |
| Average Temperature<br>Coefficient                     |  |           |      | 5   |           |      | 2    | $\mu\text{V}/^\circ\text{C}$ |
| Offset RTI vs. Supply (PSR)                            | $V_S = \pm 2.3\text{ V to } \pm 18\text{ V}$ |           |      |     |           |      |      |                              |
| G = 1  |  | 90        | 110  |     | 100       | 120  |      | dB                           |
| G = 10   |  | 110       | 130  |     | 120       | 140  |      | dB                           |
| G = 100  |  | 124       | 150  |     | 140       | 160  |      | dB                           |
| G = 1000   |  | 130       | 150  |     | 140       | 160  |      | dB                           |
| INPUT CURRENT  |  |           |      |     |           |      |      |                              |
| Input Bias Current                                     | $V_S = \pm 2.3\text{ V to } \pm 15\text{ V}$ |           | 0.5  | 1   |           | 0.2  | 0.5  | nA                           |
| Over Temperature                                       | $T = -40^\circ\text{C to }+85^\circ\text{C}$ |           |      | 2   |           |      | 1    | nA                           |
| Average Temperature<br>Coefficient                     |  |           | 4    |     |           | 4    |      | pA/ $^\circ\text{C}$         |
| Input Offset Current                                   | $V_S = \pm 2.3\text{ V to } \pm 15\text{ V}$ |           | 0.2  | 0.3 |           | 0.1  | 0.15 | nA                           |
| Over Temperature                                       | $T = -40^\circ\text{C to }+85^\circ\text{C}$ |           |      | 0.8 |           |      | 0.3  | nA                           |
| Average Temperature<br>Coefficient                     |  |           | 1    |     |           | 1    |      | pA/ $^\circ\text{C}$         |

| Parameter                                    | Test Conditions/<br>Comments                      | AD8422ARZ     |        |               | AD8422BRZ     |        |               | Unit                    |     |
|--|---|---------------|--------|---------------|---------------|--------|---------------|-------------------------|-----|
|  |   | Min           | Typ    | Max           | Min           | Typ    | Max           |                         |     |
| REFERENCE INPUT                              |   |               |        |               |               |        |               |                         |     |
| $R_{IN}$                                     | $V_{IN+}, V_{IN-}, V_{REF} = 0\text{ V}$          |               | 20     |               |               | 20     |               | k $\Omega$              |     |
| $I_{IN}$                                     |   |               | 35     | 50            |               | 35     | 50            | $\mu\text{A}$           |     |
| Voltage Range                                |   |               | $-V_S$ |               | $+V_S$        | $-V_S$ |               | $+V_S$                  | V   |
| Gain to Output                               |   |               |        | 1             |               |        | 1             |                         | V/V |
| DYNAMIC RESPONSE                             |   |               |        |               |               |        |               |                         |     |
| Small Signal –3 dB Bandwidth                 |   |               |        |               |               |        |               |                         |     |
| G = 1  |   |               | 2200   |               |               | 2200   |               | kHz                     |     |
| G = 10                                       |   |               | 850    |               |               | 850    |               | kHz                     |     |
| G = 100                                      |   |               | 120    |               |               | 120    |               | kHz                     |     |
| G = 1000                                     |   |               | 12     |               |               | 12     |               | kHz                     |     |
| Settling Time 0.01%                          |   |               |        |               |               |        |               |                         |     |
| 10 V step                                    |   |               |        |               |               |        |               |                         |     |
| G = 1  |   |               | 13     |               |               | 13     |               | $\mu\text{s}$           |     |
| G = 10                                       |   |               | 13     |               |               | 13     |               | $\mu\text{s}$           |     |
| G = 100                                      |   |               | 12     |               |               | 12     |               | $\mu\text{s}$           |     |
| G = 1000                                     |   |               | 80     |               |               | 80     |               | $\mu\text{s}$           |     |
| Settling Time 0.001%                         |   |               |        |               |               |        |               |                         |     |
| 10 V step                                    |   |               |        |               |               |        |               |                         |     |
| G = 1  |   |               | 15     |               |               | 15     |               | $\mu\text{s}$           |     |
| G = 10                                       |   |               | 15     |               |               | 15     |               | $\mu\text{s}$           |     |
| G = 100                                      |   |               | 15     |               |               | 15     |               | $\mu\text{s}$           |     |
| G = 1000                                     |   |               | 160    |               |               | 160    |               | $\mu\text{s}$           |     |
| Slew Rate                                    | G = 1 to 100                                      | 0.8           |        |               | 0.8           |        |               | V/ $\mu\text{s}$        |     |
| GAIN <sup>3</sup>                            |   |               |        |               |               |        |               |                         |     |
| G = 1 + (19.8 k $\Omega$ /R <sub>G</sub> )   |   |               |        |               |               |        |               |                         |     |
| Gain Range                                   |   | 1             |        | 1000          | 1             |        | 1000          | V/V                     |     |
| Gain Error                                   |   |               |        |               |               |        |               |                         |     |
| $V_{OUT} \pm 10\text{ V}$                    |   |               |        |               |               |        |               |                         |     |
| G = 1  |   |               |        | 0.03          |               |        | 0.01          | %                       |     |
| G = 10                                       |   |               |        | 0.2           |               |        | 0.04          | %                       |     |
| G = 100                                      |   |               |        | 0.2           |               |        | 0.04          | %                       |     |
| G = 1000                                     |   |               |        | 0.2           |               |        | 0.04          | %                       |     |
| Gain Nonlinearity                            |   |               |        |               |               |        |               |                         |     |
| $V_{OUT} = -10\text{ V to }+10\text{ V}$     |   |               |        |               |               |        |               |                         |     |
| R <sub>L</sub> = 2 k $\Omega$                |   |               |        |               |               |        |               |                         |     |
| G = 1  |   |               | 0.5    | 5             |               | 0.5    | 5             | ppm                     |     |
| G = 10                                       |   |               | 2      | 5             |               | 2      | 5             | ppm                     |     |
| G = 100                                      |   |               | 4      | 10            |               | 4      | 10            | ppm                     |     |
| G = 1000                                     |   |               | 10     | 20            |               | 10     | 20            | ppm                     |     |
| Gain vs. Temperature                         |   |               |        |               |               |        |               |                         |     |
| G = 1  |   |               |        | 5             |               |        | 1             | ppm/ $^{\circ}\text{C}$ |     |
| G > 1  |   |               |        | -80           |               |        | -80           | ppm/ $^{\circ}\text{C}$ |     |
| INPUT  |   |               |        |               |               |        |               |                         |     |
| Input Impedance                              |   |               |        |               |               |        |               |                         |     |
| Differential                                 |   |               |        |               |               |        |               |                         |     |
|  |   |               | 200  2 |               |               | 200  2 |               | G $\Omega$   pF         |     |
| Common Mode                                  |   |               |        |               |               |        |               |                         |     |
|  |   |               | 200  2 |               |               | 200  2 |               | G $\Omega$   pF         |     |
| Input Operating Voltage Range <sup>4</sup>   |   |               |        |               |               |        |               |                         |     |
| $V_S = \pm 2.3\text{ V to } \pm 18\text{ V}$ |   |               |        |               |               |        |               |                         |     |
|  |   | $-V_S + 1.2$  |        | $+V_S - 1.2$  | $-V_S + 1.2$  |        | $+V_S - 1.2$  | V                       |     |
| Over Temperature                             |   |               |        |               |               |        |               |                         |     |
|  | $T = -40^{\circ}\text{C to } +85^{\circ}\text{C}$ | $-V_S + 1.2$  |        | $+V_S - 1.3$  | $-V_S + 1.2$  |        | $+V_S - 1.3$  | V                       |     |
| OUTPUT                                       |   |               |        |               |               |        |               |                         |     |
| Output Swing, R <sub>L</sub> = 10 k $\Omega$ |   |               |        |               |               |        |               |                         |     |
| Over Temperature                             |   |               |        |               |               |        |               |                         |     |
|  | $V_S = \pm 15\text{ V}$                           | $-V_S + 0.2$  |        | $+V_S - 0.2$  | $-V_S + 0.2$  |        | $+V_S - 0.2$  | V                       |     |
|  | $T = -40^{\circ}\text{C to } +85^{\circ}\text{C}$ | $-V_S + 0.25$ |        | $+V_S - 0.25$ | $-V_S + 0.25$ |        | $+V_S - 0.25$ | V                       |     |
| Output Swing, R <sub>L</sub> = 10 k $\Omega$ |   |               |        |               |               |        |               |                         |     |
| Over Temperature                             |   |               |        |               |               |        |               |                         |     |
|  | $V_S = \pm 2.3\text{ V}$                          | $-V_S + 0.12$ |        | $+V_S - 0.12$ | $-V_S + 0.12$ |        | $+V_S - 0.12$ | V                       |     |
|  | $T = -40^{\circ}\text{C to } +85^{\circ}\text{C}$ | $-V_S + 0.13$ |        | $+V_S - 0.13$ | $-V_S + 0.13$ |        | $+V_S - 0.13$ | V                       |     |
| Output Swing, R <sub>L</sub> = 2 k $\Omega$  |   |               |        |               |               |        |               |                         |     |
| Over Temperature <sup>5</sup>                |   |               |        |               |               |        |               |                         |     |
|  | $V_S = \pm 15\text{ V}$                           | $-V_S + 0.25$ |        | $+V_S - 0.25$ | $-V_S + 0.25$ |        | $+V_S - 0.25$ | V                       |     |
|  | $T = -40^{\circ}\text{C to } +85^{\circ}\text{C}$ | $-V_S + 0.3$  |        | $+V_S - 1.4$  | $-V_S + 0.3$  |        | $+V_S - 1.4$  | V                       |     |
| Output Swing, R <sub>L</sub> = 2 k $\Omega$  |   |               |        |               |               |        |               |                         |     |
| Over Temperature                             |   |               |        |               |               |        |               |                         |     |
|  | $V_S = \pm 2.3\text{ V}$                          | $-V_S + 0.16$ |        | $+V_S - 0.16$ | $-V_S + 0.16$ |        | $+V_S - 0.16$ | V                       |     |
|  | $T = -40^{\circ}\text{C to } +85^{\circ}\text{C}$ | $-V_S + 0.2$  |        | $+V_S - 0.2$  | $-V_S + 0.2$  |        | $+V_S - 0.2$  | V                       |     |
| Short-Circuit Current                        |   |               | 20     |               |               | 20     |               | mA                      |     |

| Parameter                    | Test Conditions/<br>Comments | AD8422ARZ |     |      | AD8422BRZ |     |      | Unit |
|------------------------------|------------------------------|-----------|-----|------|-----------|-----|------|------|
|                              |                              | Min       | Typ | Max  | Min       | Typ | Max  |      |
| POWER SUPPLY                 |                              |           |     |      |           |     |      |      |
| Operating Range              | Dual-supply operation        | ±2.3      |     | ±18  | ±2.3      |     | ±18  | V    |
|                              | Single-supply operation      | 4.6       |     | 36   | 4.6       |     | 36   | V    |
| Quiescent Current            |                              |           | 300 | 330  |           | 300 | 330  | μA   |
| Over Temperature             | T = -40°C to +85°C           |           |     | 400  |           |     | 400  | μA   |
| TEMPERATURE RANGE            |                              |           |     |      |           |     |      |      |
| Specified Performance        |                              | -40       |     | +85  | -40       |     | +85  | °C   |
| Operating Range <sup>6</sup> |                              | -40       |     | +125 | -40       |     | +125 | °C   |

$$^1 \text{ Total RTI noise} = \sqrt{e_{NI}^2 + (e_{NO}/G)^2}$$

$$^2 \text{ Total RTI } V_{OS} = (V_{OSI}) + (V_{OSO}/G).$$

<sup>3</sup> Gain does not include the effects of the external resistor, R<sub>G</sub>.

<sup>4</sup> One input grounded. G = 1.

<sup>5</sup> Output current limited at cold temperatures. See Figure 33.

<sup>6</sup> See Typical Performance Characteristics for expected operation between 85°C and 125°C.

## MSOP PACKAGE

V<sub>S</sub> = ±15 V, V<sub>REF</sub> = 0 V, V<sub>+IN</sub> = 0 V, V<sub>-IN</sub> = 0 V, T<sub>A</sub> = 25°C, G = 1, R<sub>L</sub> = 2 kΩ, unless otherwise noted.

Table 2.

| Parameter                                      | Test Conditions/<br>Comments                                 | AD8422ARMZ                      |     |      | AD8422BRMZ |     |        | Unit   |
|--|--|---------------------------------|-----|------|------------|-----|--------|--------|
|  |  | Min                             | Typ | Max  | Min        | Typ | Max    |        |
| COMMON-MODE REJECTION RATIO                    |  |                                 |     |      |            |     |        |        |
| CMRR DC to 60 Hz with 1 kΩ<br>Source Imbalance | V <sub>CM</sub> = -10 V to +10 V                             |                                 |     |      |            |     |        |        |
|  |  | G = 1                           | 86  |      | 90         |     |        | dB     |
|  |  | G = 10                          | 106 |      | 110        |     |        | dB     |
|  |  | G = 100                         | 126 |      | 130        |     |        | dB     |
|  |  | G = 1000                        | 146 |      | 150        |     |        | dB     |
| Over Temperature, G = 1                        | T = -40°C to +85°C   | 83                              |     | 86   |            |     |        |        |
| CMRR at 10 kHz                                 |  |                                 |     |      |            |     |        |        |
| G = 1  | V <sub>CM</sub> = -10 V to +10 V                             |                                 |     |      |            |     |        |        |
|  |  |                                 | 80  |      | 80         |     |        | dB     |
|  |  | G = 10                          | 90  |      | 95         |     |        | dB     |
|  |  | G = 100                         | 100 |      | 100        |     |        | dB     |
|  |  | G = 1000                        | 100 |      | 100        |     |        | dB     |
| NOISE <sup>1</sup>                             |  |                                 |     |      |            |     |        |        |
| Voltage Noise, 1 kHz                           |  |                                 |     |      |            |     |        |        |
| Input Voltage Noise, e <sub>NI</sub>           | V <sub>IN+</sub> , V <sub>IN-</sub> , V <sub>REF</sub> = 0 V |                                 |     | 8    |            |     | 8      | nV/√Hz |
| Output Voltage Noise, e <sub>NO</sub>          |  |                                 |     | 80   |            |     | 80     | nV/√Hz |
| Peak to Peak, RTI                              |  |                                 |     |      |            |     |        |        |
| G = 1  | f = 0.1 Hz to 10 Hz  |                                 |     |      |            |     |        |        |
|  |  |                                 | 2   |      | 2          |     |        | μV p-p |
|  |  | G = 10                          | 0.5 |      | 0.5        |     |        | μV p-p |
| G = 100 to 1000                                |  | 0.15                            |     | 0.15 |            |     | μV p-p |        |
| Current Noise                                  | f = 1 kHz  |                                 | 90  |      | 90         |     | 110    | fA/√Hz |
|  | f = 0.1 Hz to 10 Hz  |                                 | 8   |      | 8          |     |        | pA p-p |
| VOLTAGE OFFSET <sup>2</sup>                    |  |                                 |     |      |            |     |        |        |
| Input Offset, V <sub>OSI</sub>                 |  |                                 |     |      |            |     |        |        |
| Over Temperature                               | V <sub>S</sub> = ±2.3 V to ±15 V                             |                                 |     | 70   |            |     | 50     | μV     |
|  |  |                                 |     | 110  |            |     | 75     | μV     |
|  |  | Average Temperature Coefficient |     | 0.6  |            | 0.4 |        | μV/°C  |
| Output Offset, V <sub>OSO</sub>                |  |                                 |     |      |            |     |        |        |
| Over Temperature                               | V <sub>S</sub> = ±2.3 V to ±15 V                             |                                 |     | 300  |            |     | 150    | μV     |
|  |  |                                 |     | 500  |            |     | 300    | μV     |
|  |  | Average Temperature Coefficient |     | 5    |            | 2   |        | μV/°C  |

| Parameter                       | Test Conditions/<br>Comments  | AD8422ARMZ |        |      | AD8422BRMZ |      |               | Unit             |     |
|---------------------------------|---|------------|--------|------|------------|------|---------------|------------------|-----|
|                                 |   | Min        | Typ    | Max  | Min        | Typ  | Max           |                  |     |
| Offset RTI vs. Supply (PSR)     | $V_S = \pm 2.3 \text{ V to } \pm 18 \text{ V}$  |            |        |      |            |      |               |                  |     |
| G = 1                           |   | 90         | 110    |      | 100        | 120  |               | dB               |     |
| G = 10                          |   | 110        | 130    |      | 120        | 140  |               | dB               |     |
| G = 100                         |   | 124        | 150    |      | 140        | 160  |               | dB               |     |
| G = 1000                        |   | 130        | 150    |      | 140        | 160  |               | dB               |     |
| INPUT CURRENT                   |   |            |        |      |            |      |               |                  |     |
| Input Bias Current              | $V_S = \pm 2.3 \text{ V to } \pm 15 \text{ V}$<br>$T = -40^\circ\text{C to } +85^\circ\text{C}$ |            | 0.5    | 1    |            | 0.2  | 0.5           | nA               |     |
| Over Temperature                |   |            |        |      | 2          |      |               | 1                | nA  |
| Average Temperature Coefficient |   |            | 4      |      |            | 4    |               | pA/°C            |     |
| Input Offset Current            | $V_S = \pm 2.3 \text{ V to } \pm 15 \text{ V}$<br>$T = -40^\circ\text{C to } +85^\circ\text{C}$ |            | 0.2    | 0.3  |            | 0.1  | 0.15          | nA               |     |
| Over Temperature                |   |            |        | 0.8  |            |      | 0.3           | nA               |     |
| Average Temperature Coefficient |   |            |        | 1    |            |      | 1             | pA/°C            |     |
| REFERENCE INPUT                 |   |            |        |      |            |      |               |                  |     |
| $R_{IN}$                        | $V_{IN+}, V_{IN-}, V_{REF} = 0 \text{ V}$   |            | 20     |      |            | 20   |               | k $\Omega$       |     |
| $I_{IN}$                        |   |            | 35     | 50   |            | 35   | 50            | $\mu\text{A}$    |     |
| Voltage Range                   |   |            | $-V_S$ |      | $+V_S$     |      | $-V_S$        |                  | V   |
| Gain to Output                  |   |            |        | 1    |            |      | 1             |                  | V/V |
| DYNAMIC RESPONSE                |   |            |        |      |            |      |               |                  |     |
| Small Signal –3 dB Bandwidth    | 10 V step   |            |        |      |            |      |               |                  |     |
| G = 1                           |   |            | 2200   |      |            | 2200 |               | kHz              |     |
| G = 10                          |   |            | 850    |      |            | 850  |               | kHz              |     |
| G = 100                         |   |            | 120    |      |            | 120  |               | kHz              |     |
| G = 1000                        |   |            | 12     |      |            | 12   |               | kHz              |     |
| Settling Time 0.01%             |   |            |        |      |            |      |               |                  |     |
| G = 1                           |   |            |        | 13   |            |      | 13            | $\mu\text{s}$    |     |
| G = 10                          |   |            |        | 13   |            |      | 13            | $\mu\text{s}$    |     |
| G = 100                         |   |            |        | 12   |            |      | 12            | $\mu\text{s}$    |     |
| G = 1000                        |   |            |        | 80   |            |      | 80            | $\mu\text{s}$    |     |
| Settling Time 0.001%            | 10 V step   |            |        |      |            |      |               |                  |     |
| G = 1                           |   |            | 15     |      |            | 15   | $\mu\text{s}$ |                  |     |
| G = 10                          |   |            | 15     |      |            | 15   | $\mu\text{s}$ |                  |     |
| G = 100                         |   |            | 15     |      |            | 15   | $\mu\text{s}$ |                  |     |
| G = 1000                        |   |            | 160    |      |            | 160  | $\mu\text{s}$ |                  |     |
| Slew Rate                       | G = 1 to 100  | 0.8        |        |      | 0.8        |      |               | V/ $\mu\text{s}$ |     |
| GAIN <sup>3</sup>               |   |            |        |      |            |      |               |                  |     |
| Gain Range                      | $G = 1 + (19.8 \text{ k}\Omega/R_G)$  | 1          |        | 1000 | 1          |      | 1000          | V/V              |     |
| Gain Error                      | $V_{OUT} \pm 10 \text{ V}$  |            |        | 0.03 |            |      | 0.01          | %                |     |
| G = 1                           |   |            |        | 0.2  |            |      | 0.04          | %                |     |
| G = 10                          |   |            |        | 0.2  |            |      | 0.04          | %                |     |
| G = 100                         |   |            |        | 0.2  |            |      | 0.04          | %                |     |
| G = 1000                        |   |            |        | 0.2  |            |      | 0.04          | %                |     |
| Gain Nonlinearity               | $V_{OUT} = -10 \text{ V to } +10 \text{ V}$<br>$R_L = 2 \text{ k}\Omega$                        |            | 0.5    | 5    |            | 0.5  | 5             | ppm              |     |
| G = 1                           |   |            | 2      | 5    |            | 2    | 5             | ppm              |     |
| G = 10                          |   |            | 4      | 10   |            | 4    | 10            | ppm              |     |
| G = 100                         |   |            | 10     | 20   |            | 10   | 20            | ppm              |     |
| G = 1000                        |   |            |        |      |            |      |               |                  |     |
| Gain vs. Temperature            |   |            |        | 5    |            |      | 1             | ppm/°C           |     |
| G > 1                           |   |            |        | –80  |            |      | –80           | ppm/°C           |     |

| Parameter                                  | Test Conditions/<br>Comments     | AD8422ARMZ             |        |                        | AD8422BRMZ             |        |                        | Unit   |
|--|----------------------------------|------------------------|--------|------------------------|------------------------|--------|------------------------|--------|
|  |                                  | Min                    | Typ    | Max                    | Min                    | Typ    | Max                    |        |
| INPUT                                      |                                  |                        |        |                        |                        |        |                        |        |
| Input Impedance                            |                                  |                        |        |                        |                        |        |                        |        |
| Differential                               |                                  |                        | 200  2 |                        |                        | 200  2 |                        | GΩ  pF |
| Common Mode                                |                                  |                        | 200  2 |                        |                        | 200  2 |                        | GΩ  pF |
| Input Operating Voltage Range <sup>4</sup> | V <sub>S</sub> = ±2.3 V to ±18 V | -V <sub>S</sub> + 1.2  |        | +V <sub>S</sub> - 1.2  | -V <sub>S</sub> + 1.2  |        | +V <sub>S</sub> - 1.2  | V      |
| Over Temperature                           | T = -40°C to +85°C               | -V <sub>S</sub> + 1.2  |        | +V <sub>S</sub> - 1.3  | -V <sub>S</sub> + 1.2  |        | +V <sub>S</sub> - 1.3  | V      |
| OUTPUT                                     |                                  |                        |        |                        |                        |        |                        |        |
| Output Swing, R <sub>L</sub> = 10 kΩ       | V <sub>S</sub> = ±15 V           | -V <sub>S</sub> + 0.2  |        | +V <sub>S</sub> - 0.2  | -V <sub>S</sub> + 0.2  |        | +V <sub>S</sub> - 0.2  | V      |
| Over Temperature                           | T = -40°C to +85°C               | -V <sub>S</sub> + 0.25 |        | +V <sub>S</sub> - 0.25 | -V <sub>S</sub> + 0.25 |        | +V <sub>S</sub> - 0.25 | V      |
| Output Swing, R <sub>L</sub> = 10 kΩ       | V <sub>S</sub> = ±2.3 V          | -V <sub>S</sub> + 0.12 |        | +V <sub>S</sub> - 0.12 | -V <sub>S</sub> + 0.12 |        | +V <sub>S</sub> - 0.12 | V      |
| Over Temperature                           | T = -40°C to +85°C               | -V <sub>S</sub> + 0.13 |        | +V <sub>S</sub> - 0.13 | -V <sub>S</sub> + 0.13 |        | +V <sub>S</sub> - 0.13 | V      |
| Output Swing, R <sub>L</sub> = 2 kΩ        | V <sub>S</sub> = ±15 V           | -V <sub>S</sub> + 0.25 |        | +V <sub>S</sub> - 0.25 | -V <sub>S</sub> + 0.25 |        | +V <sub>S</sub> - 0.25 | V      |
| Over Temperature <sup>5</sup>              | T = -40°C to +85°C               | -V <sub>S</sub> + 0.3  |        | +V <sub>S</sub> - 1.4  | -V <sub>S</sub> + 0.3  |        | +V <sub>S</sub> - 1.4  | V      |
| Output Swing, R <sub>L</sub> = 2 kΩ        | V <sub>S</sub> = ±2.3 V          | -V <sub>S</sub> + 0.16 |        | +V <sub>S</sub> - 0.16 | -V <sub>S</sub> + 0.16 |        | +V <sub>S</sub> - 0.16 | V      |
| Over Temperature                           | T = -40°C to +85°C               | -V <sub>S</sub> + 0.2  |        | +V <sub>S</sub> - 0.2  | -V <sub>S</sub> + 0.2  |        | +V <sub>S</sub> - 0.2  | V      |
| Short-Circuit Current                      |                                  |                        | 20     |                        |                        | 20     |                        | mA     |
| POWER SUPPLY                               |                                  |                        |        |                        |                        |        |                        |        |
| Operating Range                            | Dual-supply operation            | ±2.3                   |        | ±18                    | ±2.3                   |        | ±18                    | V      |
|  | Single-supply operation          | 4.6                    |        | 36                     | 4.6                    |        | 36                     | V      |
| Quiescent Current                          |                                  |                        | 300    | 330                    |                        | 300    | 330                    | μA     |
| Over Temperature                           | T = -40°C to +85°C               |                        |        | 400                    |                        |        | 400                    | μA     |
| TEMPERATURE RANGE                          |                                  |                        |        |                        |                        |        |                        |        |
| Specified Performance                      |                                  | -40                    |        | +85                    | -40                    |        | +85                    | °C     |
| Operating Range <sup>6</sup>               |                                  | -40                    |        | +125                   | -40                    |        | +125                   | °C     |

<sup>1</sup> Total RTI Noise =  $\sqrt{e_{NI}^2 + (e_{NO}/G)^2}$

<sup>2</sup> Total RTI V<sub>OS</sub> = (V<sub>OSI</sub>) + (V<sub>OSO</sub>/G).

<sup>3</sup> Gain does not include the effects of the external resistor, R<sub>G</sub>.

<sup>4</sup> One input grounded. G = 1.

<sup>5</sup> Output current limited at cold temperatures. See Figure 33.

<sup>6</sup> See Typical Performance Characteristics for expected operation between 85°C and 125°C.

## ABSOLUTE MAXIMUM RATINGS

Table 3.

| Parameter                                      | Rating                                     |
|--|--|
| Supply Voltage                                 | $\pm 2.3 \text{ V to } \pm 18 \text{ V}$   |
| Output Short-Circuit Current Duration          | Indefinite                                 |
| Maximum Voltage at $-IN$ or $+IN$ <sup>1</sup> | $-V_S + 40 \text{ V}$                      |
| Minimum Voltage at $-IN$ or $+IN$              | $+V_S - 40 \text{ V}$                      |
| Maximum Voltage at REF                         | $\pm V_S \pm 0.3 \text{ V}$                |
| Storage Temperature Range                      | $-65^\circ\text{C to } +150^\circ\text{C}$ |
| Operating Temperature Range                    | $-40^\circ\text{C to } +125^\circ\text{C}$ |
| Maximum Junction Temperature                   | $150^\circ\text{C}$                        |
| ESD  |  |
| Human Body Model                               | 2.5 kV                                     |
| Charge Device Model                            | 1.25 kV                                    |
| Machine Model                                  | 100 V                                      |

<sup>1</sup>For voltages beyond these limits, use input protection resistors. See the Theory of Operation section for more information.

Stresses at or above those listed under Absolute Maximum Ratings may cause permanent damage to the product. This is a stress rating only; functional operation of the product at these or any other conditions above those indicated in the operational section of this specification is not implied. Operation beyond the maximum operating conditions for extended periods may affect product reliability.

## THERMAL RESISTANCE

$\theta_{JA}$  is specified for a device in free air using a 4-layer JEDEC printed circuit board (PCB).

Table 4.

| Package     | $\theta_{JA}$ | Unit               |
|-------------|---------------|--------------------|
| 8-Lead SOIC | 100           | $^\circ\text{C/W}$ |
| 8-Lead MSOP | 162           | $^\circ\text{C/W}$ |

## ESD CAUTION



**ESD (electrostatic discharge) sensitive device.** Charged devices and circuit boards can discharge without detection. Although this product features patented or proprietary protection circuitry, damage may occur on devices subjected to high energy ESD. Therefore, proper ESD precautions should be taken to avoid performance degradation or loss of functionality.



## PIN CONFIGURATION AND FUNCTION DESCRIPTIONS



Figure 3. Pin Configuration

Table 5. Pin Function Descriptions

| Pin No. | Mnemonic         | Description   |
|---------|------------------|---|
| 1       | -IN              | Negative Input Terminal.  |
| 2, 3    | R <sub>G</sub>   | Gain Setting Terminals. Place resistor across the R <sub>G</sub> pins to set the gain. $G = 1 + (19.8 \text{ k}\Omega/R_G)$ . |
| 4       | +IN              | Positive Input Terminal.  |
| 5       | -V <sub>S</sub>  | Negative Power Supply Terminal.   |
| 6       | REF              | Reference Voltage Terminal. Drive this terminal with a low impedance voltage source to level shift the output.                |
| 7       | V <sub>OUT</sub> | Output Terminal.  |
| 8       | +V <sub>S</sub>  | Positive Power Supply Terminal.   |

# TYPICAL PERFORMANCE CHARACTERISTICS

T = 25°C, V<sub>S</sub> = ±15, V<sub>REF</sub> = 0 V, R<sub>L</sub> = 10 kΩ, unless otherwise noted.



Figure 4. Typical Distribution of Input Offset Voltage

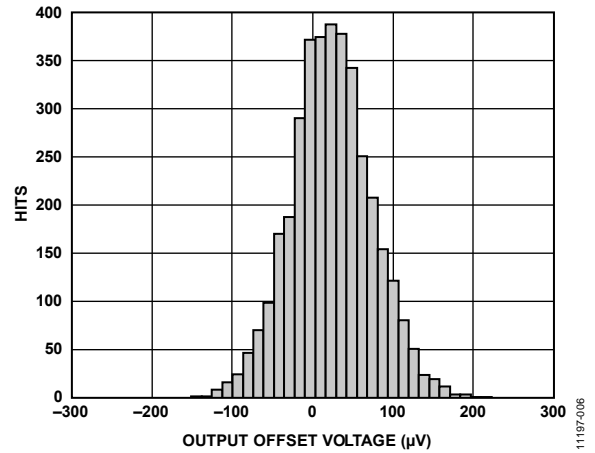

Figure 7. Typical Distribution of Output Offset Voltage



Figure 5. Typical Distribution of Input Bias Current



Figure 8. Typical Distribution of Input Offset Current



Figure 6. Typical Distribution of PSRR (G = 1)



Figure 9. Typical Distribution of CMRR (G = 1)



Figure 10. Input Common-Mode Voltage vs. Output Voltage ( $G = 1$ ),  $V_S = \pm 15\text{ V}$ ,  $V_S = \pm 12\text{ V}$ ,  $V_S = \pm 5\text{ V}$



Figure 13. Input Common-Mode Voltage vs. Output Voltage ( $G = 100$ ), Single-Supply,  $V_S = 5\text{ V}$



Figure 11. Input Common-Mode Voltage vs. Output Voltage ( $G = 1$ ), Single-Supply,  $V_S = 5\text{ V}$



Figure 14. Input Overvoltage Performance;  $G = 1$ ,  $V_S = 5\text{ V}$



Figure 12. Input Common-Mode Voltage vs. Output Voltage ( $G = 100$ ),  $V_S = \pm 15\text{ V}$ ,  $V_S = \pm 12\text{ V}$ ,  $V_S = \pm 5\text{ V}$



Figure 15. Input Overvoltage Performance;  $G = 1$ ,  $V_S = \pm 15\text{ V}$



Figure 16. Input Overvoltage Performance;  $G = 100$ ,  $V_S = 5\text{ V}$

11197-017

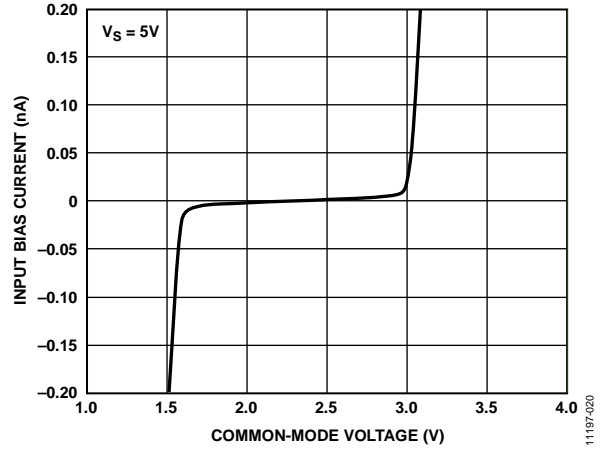

Figure 19. Input Bias Current vs. Common-Mode Voltage,  $V_S = 5\text{ V}$

11197-020



Figure 17. Input Overvoltage Performance;  $G = 100$ ,  $V_S = \pm 15\text{ V}$

11197-018

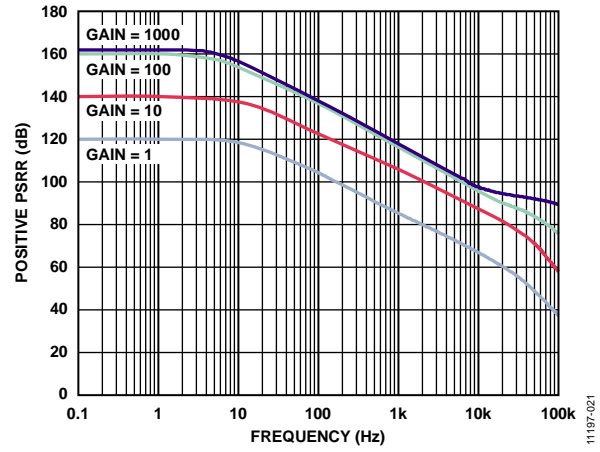

Figure 20. Positive PSRR vs. Frequency

11197-021

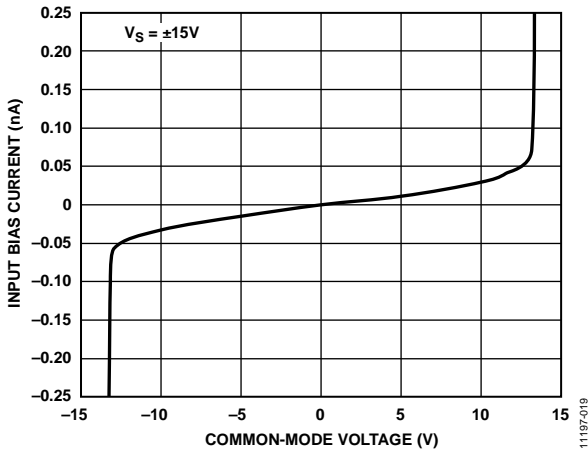

Figure 18. Input Bias Current vs. Common-Mode Voltage,  $V_S = \pm 15\text{ V}$

11197-019

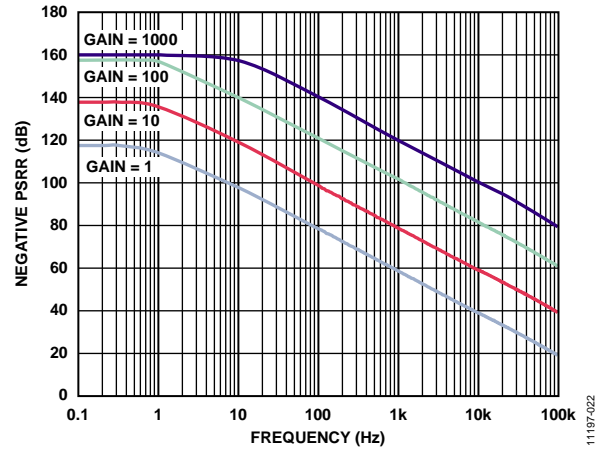

Figure 21. Negative PSRR vs. Frequency

11197-022

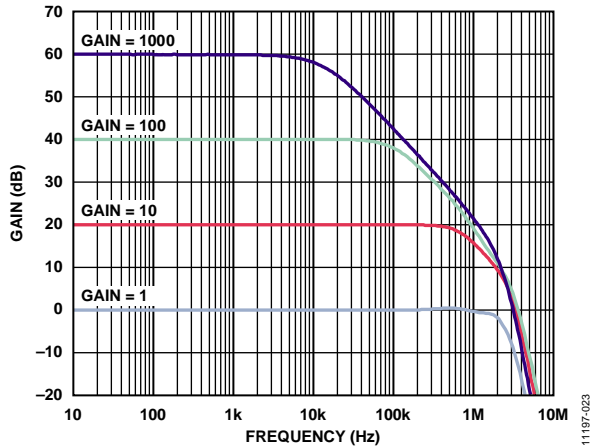

Figure 22. Gain vs. Frequency

11197-023



Figure 25. Change in Input Offset Voltage ( $V_{OS}$ ) vs. Warm-Up Time

11197-026

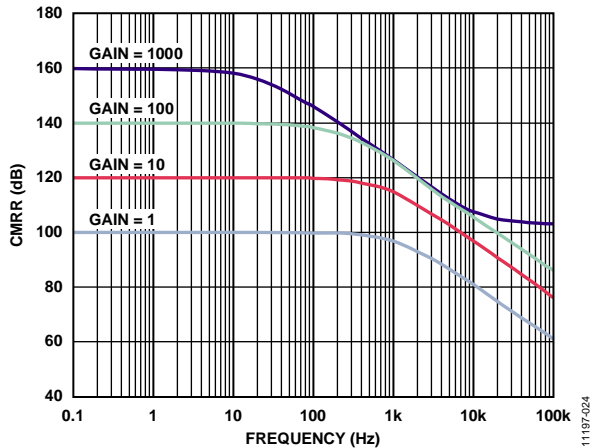

Figure 23. CMRR vs. Frequency

11197-024



Figure 26. Input Bias Current and Input Offset Current vs. Temperature

11197-027

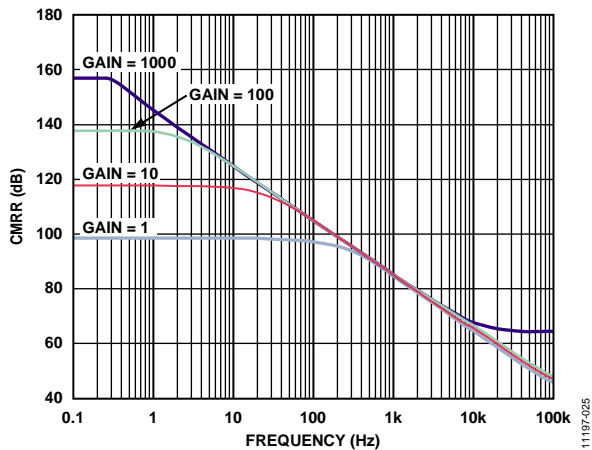

Figure 24. CMRR vs. Frequency, 1 k $\Omega$  Source Imbalance

11197-025



Figure 27. Gain vs. Temperature ( $G = 1$ )

11197-028



Figure 28. CMRR vs. Temperature ( $G = 1$ ), Normalized at 25°C

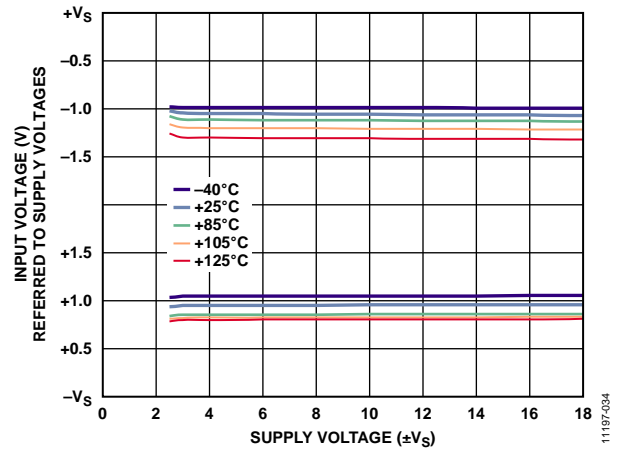

Figure 31. Input Voltage Limit vs. Supply Voltage

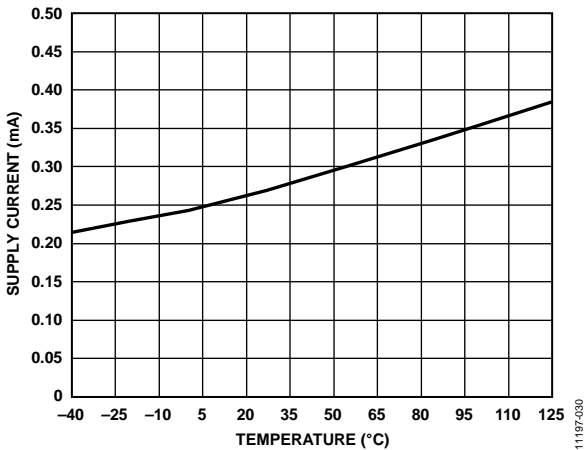

Figure 29. Supply Current vs. Temperature ( $G = 1$ )

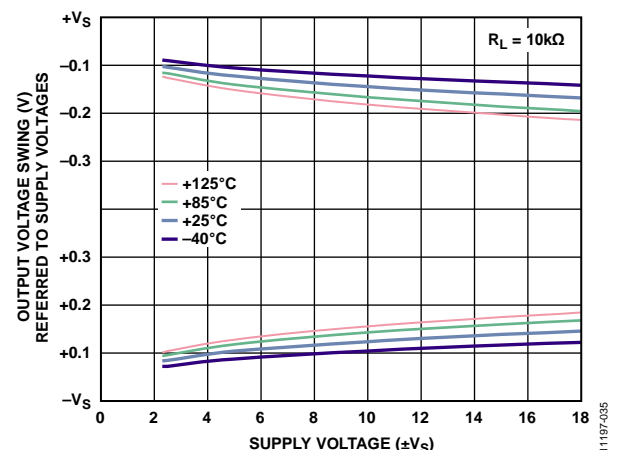

Figure 32. Output Voltage Swing vs. Supply Voltage,  $R_L = 10\text{ k}\Omega$



Figure 30. Short-Circuit Current vs. Temperature ( $G = 1$ )

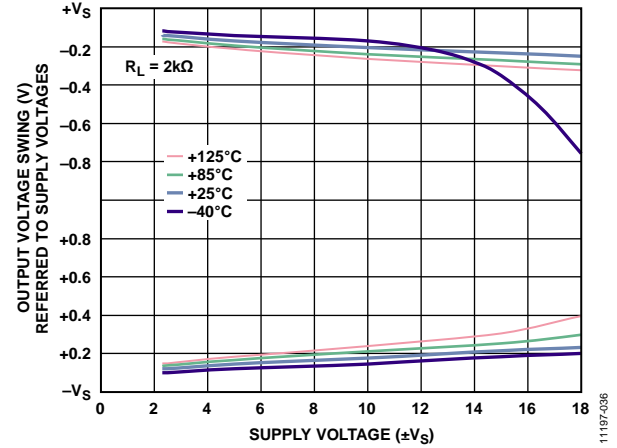

Figure 33. Output Voltage Swing vs. Supply Voltage,  $R_L = 2\text{ k}\Omega$

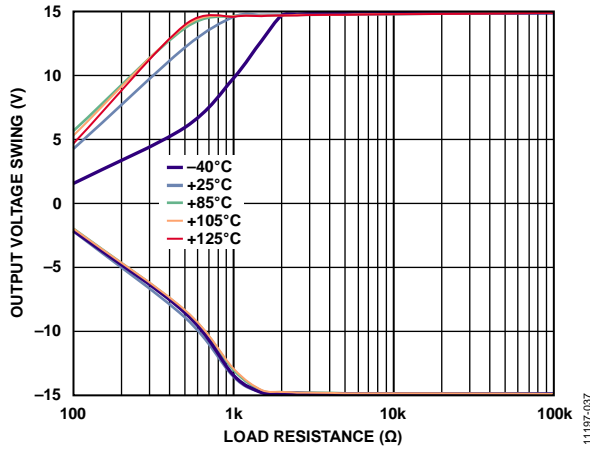

Figure 34. Output Voltage Swing vs. Load Resistance

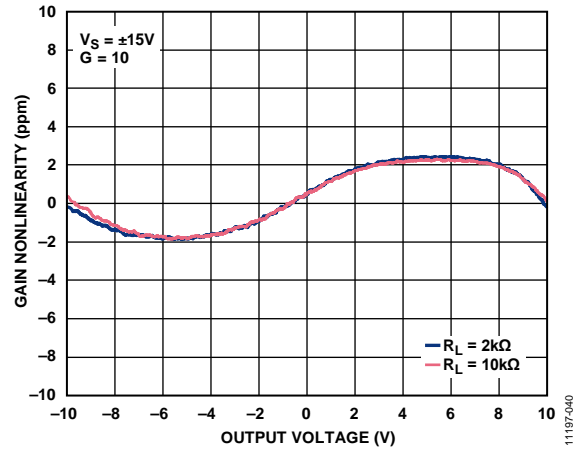

Figure 37. Gain Nonlinearity (G = 10)

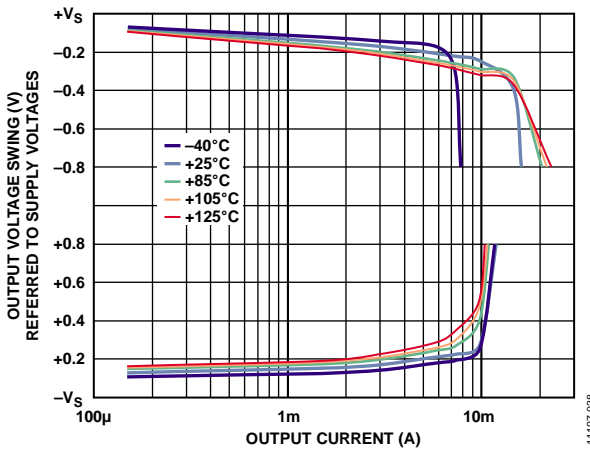

Figure 35. Output Voltage Swing vs. Output Current

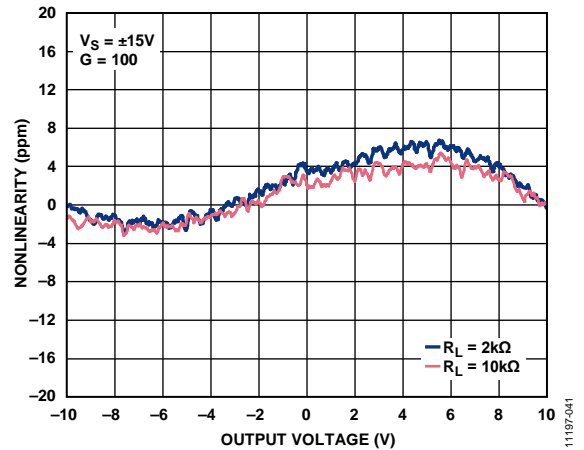

Figure 38. Gain Nonlinearity (G = 100)

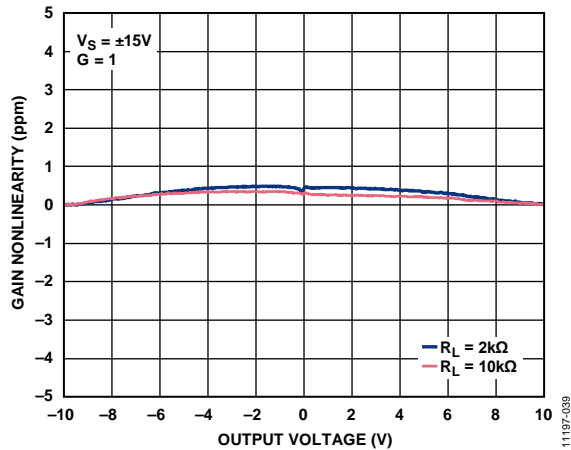

Figure 36. Gain Nonlinearity (G = 1)

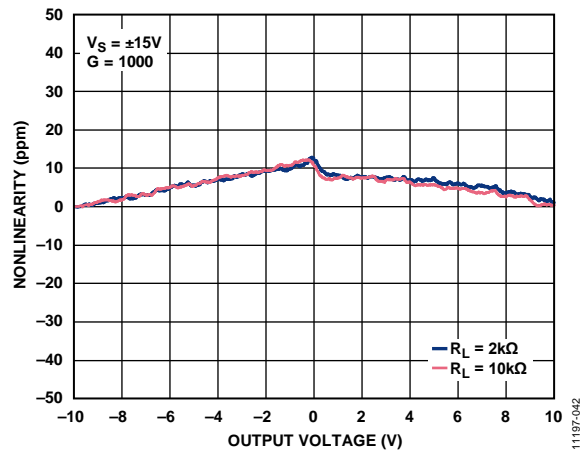

Figure 39. Gain Nonlinearity (G = 1000)

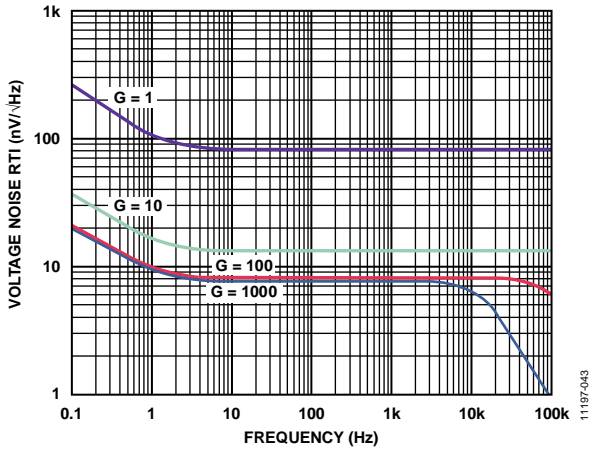

Figure 40. Voltage Noise Spectral Density vs. Frequency

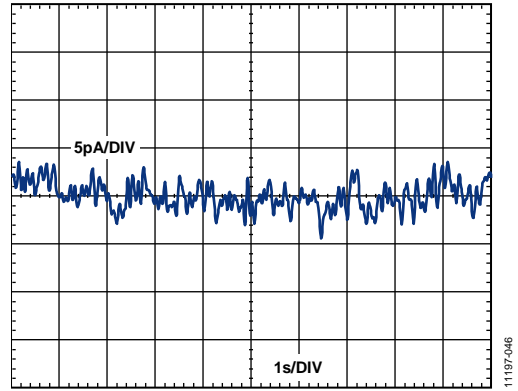

Figure 43. 0.1 Hz to 10 Hz Current Noise

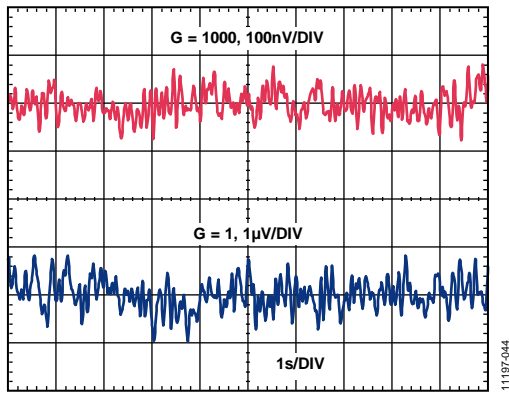

Figure 41. 0.1 Hz to 10 Hz RTI Voltage Noise ( $G = 1$ ,  $G = 1000$ )

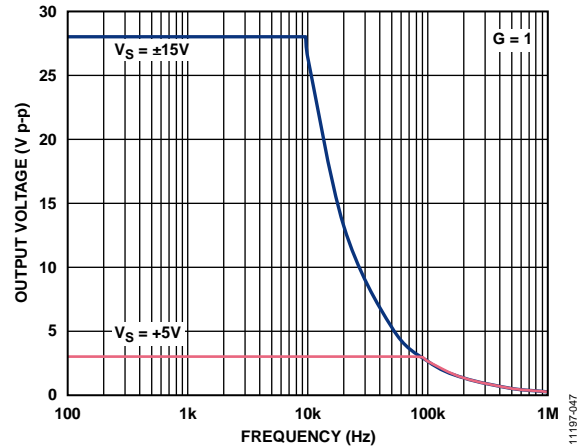

Figure 44. Large Signal Frequency Response

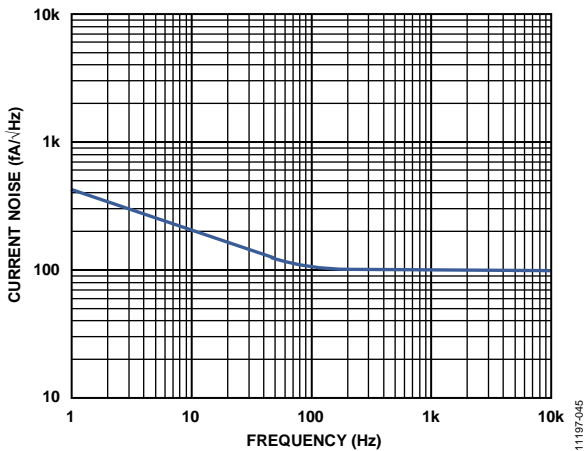

Figure 42. Current Noise Spectral Density vs. Frequency

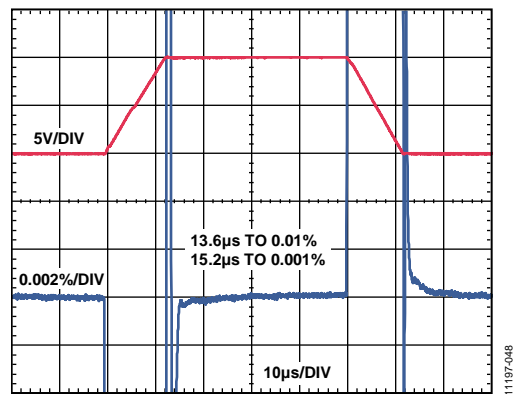

Figure 45. Large Signal Pulse Response and Settling Time ( $G = 1$ ), 10 V Step,  $V_S = \pm 15$  V,  $R_L = 2$  k $\Omega$ ,  $C_L = 100$  pF





Figure 46. Large Signal Pulse Response and Settling Time ( $G = 10$ ), 10 V Step,  $V_S = \pm 15$  V,  $R_L = 2$  k $\Omega$ ,  $C_L = 100$  pF



Figure 49. Settling Time vs. Step Size ( $G = 1$ )



Figure 47. Large Signal Pulse Response and Settling Time ( $G = 100$ ), 10 V Step,  $V_S = \pm 15$  V,  $R_L = 2$  k $\Omega$ ,  $C_L = 100$  pF



Figure 50. Small Signal Pulse Response ( $G = 1$ ),  $R_L = 2$  k $\Omega$ ,  $C_L = 100$  pF



Figure 48. Large Signal Pulse Response and Settling Time ( $G = 1000$ ), 10 V Step,  $V_S = \pm 15$  V,  $R_L = 2$  k $\Omega$ ,  $C_L = 100$  pF

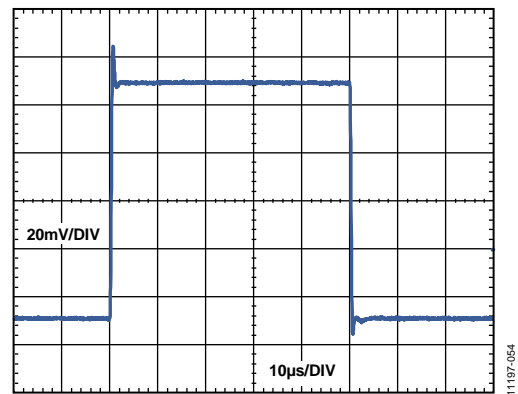

Figure 51. Small Signal Pulse Response ( $G = 10$ ),  $R_L = 2$  k $\Omega$ ,  $C_L = 100$  pF

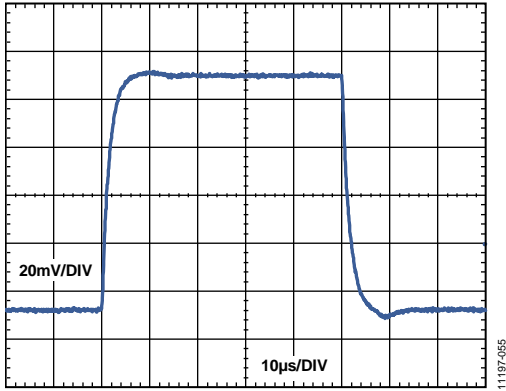

Figure 52. Small Signal Pulse Response ( $G = 100$ ),  $R_L = 2\text{ k}\Omega$ ,  $C_L = 100\text{ pF}$

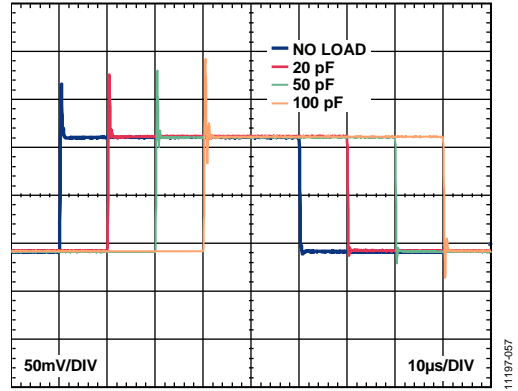

Figure 54. Small Signal Pulse Response with Various Capacitive Loads ( $G = 1$ ),  $R_L = \text{No Load}$

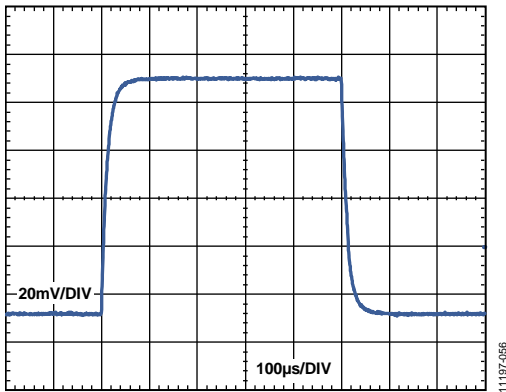

Figure 53. Small Signal Pulse Response ( $G = 1000$ ),  $R_L = 2\text{ k}\Omega$ ,  $C_L = 100\text{ pF}$

## THEORY OF OPERATION



Figure 55. Simplified Schematic

### ARCHITECTURE

The AD8422 is based on the classic 3-op-amp instrumentation amplifier topology. This topology has two stages: a preamplifier to provide differential amplification followed by a difference amplifier that removes the common-mode voltage. Figure 55 shows a simplified schematic of the AD8422.

Topologically, Q1, A1, R1 and Q2, A2, R2 can be viewed as precision current feedback amplifiers that maintain a fixed current in the emitters of Q1 and Q2. Any change in the input signal forces the output voltages of A1 and A2 to change accordingly and maintain the Q1 and Q2 current at the correct value. This causes a precise diode drop from -IN and +IN to Node 3 and Node 4, respectively, so that the differential signal applied to the inputs is replicated across the RG pins. Any current through RG must also flow through R1 and R2, creating the gained differential voltage between Node 1 and Node 2.

The amplified differential signal and the common-mode signal are applied to a difference amplifier that rejects the common-mode voltage but preserves the amplified differential voltage.

Laser-trimmed resistors allow for a highly accurate in-amp with a gain error of less than 0.01% and a CMRR that exceeds 94 dB ( $G = 1$ ). The supply current is precisely trimmed to reduce uncertainties due to part-to-part variations in power dissipation and noise. The high performance pinout and special attention to design and layout allow for high CMRR across a wide frequency and temperature range. Using superbeta input transistors and bias current compensation, the AD8422 offers extremely high input impedance and low bias current, as well as very low voltage noise while using only 300  $\mu$ A supply current. The overvoltage protection scheme allows the input to go 40 V from the opposite rail at all gains without compromising the noise performance.

The transfer function of the AD8422 is

$$V_{OUT} = G \times (V_{IN+} - V_{IN-}) + V_{REF}$$

where:

$$G = 1 + \frac{19.8 \text{ k}\Omega}{R_G}$$

### GAIN SELECTION

Placing a resistor across the RG terminals sets the gain of the AD8422 that can be calculated by referring to Table 6 or by using the following gain equation:

$$R_G = \frac{19.8 \text{ k}\Omega}{G - 1}$$

The AD8422 defaults to  $G = 1$  when no gain resistor is used. Add the tolerance and gain drift of the RG resistor to the specifications of the AD8422 to determine the total gain accuracy of the system. When the gain resistor is not used, gain error and gain drift are minimal.

Table 6. Gains Achieved Using 1% Resistors

| 1% Standard Table Value of $R_G$ ( $\Omega$ ) | Calculated Gain |
|---|-----------------|
| 19.6 k  | 2.010           |
| 4.99 k  | 4.968           |
| 2.21 k  | 9.959           |
| 1.05 k  | 19.86           |
| 402   | 50.25           |
| 200   | 100.0           |
| 100   | 199.0           |
| 39.2  | 506.1           |
| 20  | 991.0           |

### $R_G$ Power Dissipation

The AD8422 duplicates the differential voltage across its inputs onto the  $R_G$  resistor. Choose an  $R_G$  resistor size that is sufficient to handle the expected power dissipation at ambient temperature.

### REFERENCE TERMINAL

The output voltage of the AD8422 is developed with respect to the potential on the reference terminal. This can be used to apply a precise offset to the output signal. For example, a voltage source can be tied to the REF pin to level shift the output, allowing the AD8422 to drive a unipolar analog-to-digital converter (ADC). The REF pin is protected with ESD diodes and must not exceed either  $+V_S$  or  $-V_S$  by more than 0.3 V.

For best performance, maintain a source impedance to the REF terminal that is below 1  $\Omega$ . As shown in Figure 55, the reference terminal, REF, is at one end of a 10 k $\Omega$  resistor. Additional impedance at the REF terminal adds to this 10 k $\Omega$  resistor and results in amplification of the signal connected to the positive input.

The amplification from the additional  $R_{REF}$  can be calculated as

$$2(10 \text{ k}\Omega + R_{REF}) / (20 \text{ k}\Omega + R_{REF})$$

Only the positive signal path is amplified; the negative path is unaffected. This uneven amplification degrades CMRR.



Figure 56. Driving the Reference Pin (REF)

### INPUT VOLTAGE RANGE

The 3-op-amp architecture of the AD8422 applies gain in the first stage before removing common-mode voltage with the difference amplifier stage. Internal nodes between the first and second stages (Node 1 and Node 2 in Figure 55) experience a combination of a gained signal, a common-mode signal, and a diode drop. The voltage supplies can limit the combined signal, even when the individual input and output signals are not limited. Figure 10 through Figure 13 show this limitation in detail.

### LAYOUT

To ensure optimum performance of the AD8422 at the PCB level, take care in the design of the board layout. To aid in this task, the pins of the AD8422 are arranged in a logical manner.



Figure 57. Pinout Diagram

### Common-Mode Rejection Ratio over Frequency

Poor layout can cause some of the common-mode signals to be converted to differential signals before reaching the in-amp. Such conversions occur when one input path has a frequency response that is different from the other. To maintain high CMRR over frequency, closely match the input source impedance and capacitance of each path. Place additional source resistance in the input path (for example, for input protection) close to the in-amp inputs, which minimizes their interaction with parasitic capacitance from the PCB traces.

Parasitic capacitance at the gain setting pins ( $R_G$ ) can also affect CMRR over frequency. If the board design has a component at the gain setting pins (for example, a switch or jumper), choose a component such that the parasitic capacitance is as small as possible.

### Power Supplies and Grounding

Use a stable dc voltage to power the instrumentation amplifier. Noise on the supply pins can adversely affect performance.

Place a 0.1  $\mu\text{F}$  capacitor as close as possible to each supply pin. Because the length of the bypass capacitor leads is critical at high frequency, surface-mount capacitors are recommended. A parasitic inductance in the bypass ground trace works against the low impedance created by the bypass capacitor. As shown in Figure 58, a 10  $\mu\text{F}$  capacitor can be used farther away from the device. For larger value capacitors, intended to be effective at lower frequencies, the current return path distance is less critical. In most cases, this capacitor can be shared by other local precision integrated circuits.



Figure 58. Supply Decoupling, REF, and Output Referred to Local Ground

A ground plane layer is helpful to reduce parasitic inductances. This minimizes voltage drops with changes in current. The area of the current path is directly proportional to the magnitude of parasitic inductances and, therefore, the impedance of the path at high frequencies. Large changes in currents in an inductive decoupling path or ground return create unwanted effects due to the coupling of such changes into the amplifier inputs.

Because load currents flow from the supplies, connect the load at the same physical location as the bypass capacitor grounds.

**Reference Pin**

The output voltage of the AD8422 is developed with respect to the potential on the reference terminal. Ensure that REF is tied to the appropriate local ground.

**INPUT BIAS CURRENT RETURN PATH**

The input bias current of the AD8422 must have a dc return path to ground. When using a floating source without a current return path, such as a thermocouple, create a current return path, as shown in Figure 59.



Figure 59. Creating an Input Bias Current Return Path

**INPUT VOLTAGES BEYOND THE SUPPLY RAILS**

Many instrumentation amplifiers specify excellent CMRR and input impedance, but in a real system, the performance suffers because of the external components required for input protection. The AD8422 has very robust inputs. It typically does not need additional input protection. Input voltages can be up to 40 V from the opposite supply rail without damage to the part. For example, with a +5 V positive supply and a 0 V negative supply, the part can safely withstand voltages from -35 V to +40 V. Unlike some other instrumentation amplifiers, the part can handle large differential input voltages even when the part is in high gain.



Figure 60. Input Overvoltage Protection with no External Components

For input voltages less than 40 V from the opposite rail, no input protection is required.

Keep the rest of the AD8422 terminals within the supplies. All terminals of the AD8422 are protected against ESD.

**Input Voltages Beyond the Maximum Ratings**

For applications where the AD8422 encounters voltages beyond the limits in the Absolute Maximum Ratings section, external protection is required. This external protection depends on the duration of the overvoltage event and the noise performance required.

For short-lived events, transient protectors such as metal oxide varistors (MOVs) may be all that is required.

For longer events, use resistors in series with the inputs combined with diodes. To avoid worsening bias current performance, low leakage diodes, such as the BAV199 or FJH1100s, are recommended. The diodes prevent the voltage at the input of the amplifier from exceeding the maximum ratings, while the resistors limit the current into the diodes. Because most external diodes can easily handle 100 mA or more, resistor values do not have to be large. Therefore, the protection resistance has minimal impact on noise performance.



Figure 61. Input Protection Options for Input Voltages Beyond Absolute Maximum Ratings

At the expense of some noise performance, another solution is to use series resistors. In the overvoltage case, current into the inputs of the AD8422 is internally limited to a safe value for the amplifier. Although the AD8422 inputs must still be kept within the Absolute Maximum Ratings, the  $I \times R$  drop across the protection resistor increases the maximum voltage that the system can withstand to the following values:

For positive input signals,

$$V_{MAX\_NEW} = (40 \text{ V} + \text{Negative Supply}) + I_{IN} \times R_{PROTECT}$$

For negative input signals,

$$V_{MIN\_NEW} = (\text{Positive Supply} - 40 \text{ V}) - I_{OUT} \times R_{PROTECT}$$

Overvoltage performance is shown in Figure 14, Figure 15, Figure 16, and Figure 17. With gains greater than 100 and supply voltages less than  $\pm 2.5 \text{ V}$ , overdrive voltages beyond the rails may cause the output to invert as far as the REF pin voltage.

## RADIO FREQUENCY INTERFERENCE (RFI)

RF rectification is often a problem when amplifiers are used in applications that have strong RF signals. The disturbance can appear as a small dc offset voltage. High frequency signals can be filtered with a low-pass RC network placed at the input of the instrumentation amplifier, as shown in Figure 62.



Figure 62. RFI Suppression

The filter limits the input signal bandwidth, according to the following relationship:

$$\text{FilterFrequency}_{DIFF} = \frac{1}{2\pi R(2C_D + C_C)}$$

$$\text{FilterFrequency}_{CM} = \frac{1}{2\pi RC_C}$$

where  $C_D \geq 10 C_C$ .

$C_D$  affects the difference signal, and  $C_C$  affects the common-mode signal. Choose values of  $R$  and  $C_C$  that minimize RFI. A mismatch between  $R \times C_C$  at the positive input and  $R \times C_C$  at the negative input degrades the CMRR of the AD8422. By using a value of  $C_D$  that is one order of magnitude larger than  $C_C$ , the effect of the mismatch is reduced, and performance is improved.

Resistors add noise; therefore, the choice of the resistor and capacitor values depends on the desired tradeoff between noise, input impedance at high frequencies, and RF immunity. The resistors used for the RFI filter can be the same as those used for input protection.

## APPLICATIONS INFORMATION

### PRECISION BRIDGE CONDITIONING

With its high CMRR, low drift, and rail-to-rail output, the AD8422 is an excellent choice for conditioning a signal from a Wheatstone bridge. With appropriate supply voltages, the gain and reference pin voltage can be adjusted to match the full-scale bridge output to any desired output range, such as 0 V to 5 V. Figure 63 shows a circuit to convert a bridge signal into a 4 mA to 20 mA output using the AD8276 low power, precision difference amplifier, and the ADA4096-2 low power, rail-to-rail input and output, overvoltage protected op amp. With high precision bridge circuits, care must be taken to compensate offsets and temperature errors. For example, if the voltage at the REF pin is used to compensate for the bridge offset, ensure that the AD8422 is within its operating range for the maximum expected offset. If the zero-adjust potentiometer is excluded, connect the positive op amp input to the center of the 24.9 k $\Omega$ , 10.7 k $\Omega$  divider, which is at 1.5 V. If lower supply voltages are used for the AD8276 and the

ADA4096-2, ensure that the desired output voltage of the AD8276 is within its output range, and  $V_L$  is within the input and output range of the ADA4096-2. The transistor must have sufficient breakdown voltage and  $I_C$ . Low cost transistors, such as the BC847 or 2N5210, are recommended.

### PROCESS CONTROL ANALOG INPUT

In process control systems such as programmable logic controllers (PLC) and distributed control systems (DCS), analog variables typically occur in just a few standard voltage or current ranges, including 4 mA to 20 mA and  $\pm 10$  V. Variables within these input ranges must often be gained or attenuated and level shifted to match a specific ADC input range such as 0 V to 5 V. The circuit in Figure 64 shows one way this can be done with a single AD8422. Low power, overvoltage protection, and high precision make the AD8422 a good match for process control applications, and high input impedance, low bias current, and low current noise allow significant source resistance with minimum additional errors.

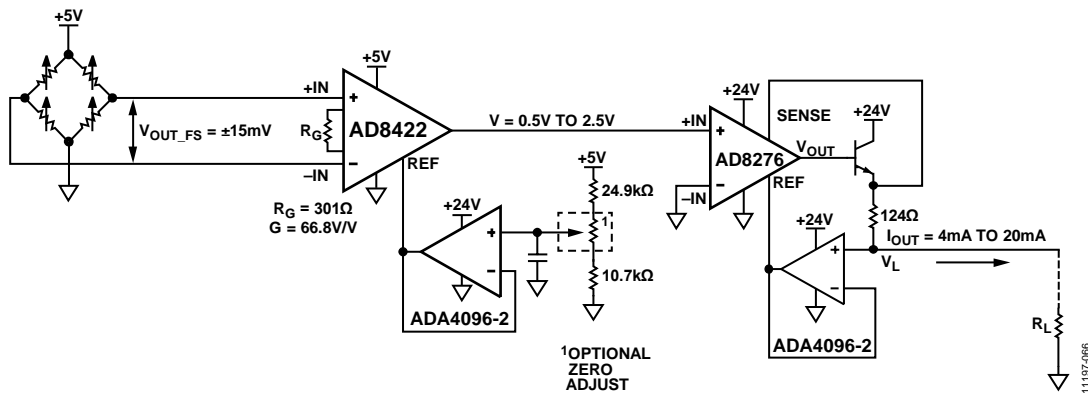
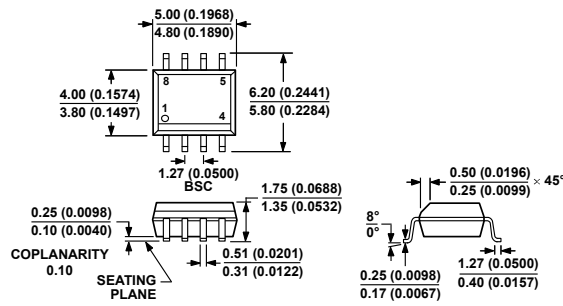

Figure 63. Bridge Circuit with 4 mA to 20 mA Output



Figure 64. Process Control Analog Input

OUTLINE DIMENSIONS



COMPLIANT TO JEDEC STANDARDS MS-012-AA  
CONTROLLING DIMENSIONS ARE IN MILLIMETERS; INCH DIMENSIONS (IN PARENTHESES) ARE ROUNDED-OFF MILLIMETER EQUIVALENTS FOR REFERENCE ONLY AND ARE NOT APPROPRIATE FOR USE IN DESIGN.

Figure 65. 8-Lead Standard Small Outline Package [SOIC\_N] Narrow Body (R-8)  
Dimensions shown in millimeters and (inches)

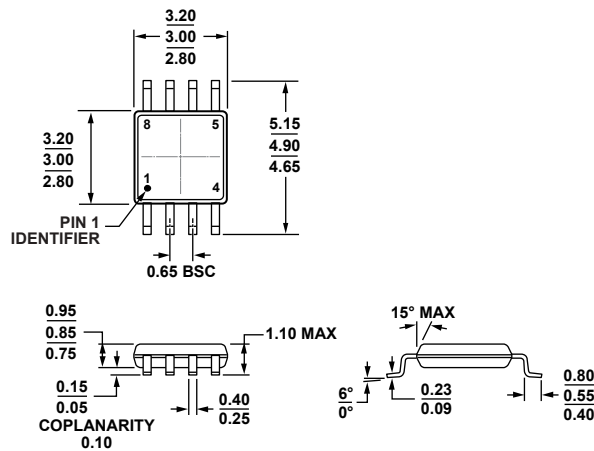

COMPLIANT TO JEDEC STANDARDS MO-187-AA  
Figure 66. 8-Lead Mini Small Outline Package [MSOP] (RM-8)  
Dimensions shown in millimeters

ORDERING GUIDE

| Model <sup>1</sup> | Temperature Range | Package Description                                      | Package Option | Branding |
|--------------------|-------------------|--|----------------|----------|
| AD8422ARZ          | -40°C to +85°C    | 8-Lead SOIC_N, Standard Grade                            | R-8            |          |
| AD8422ARZ-R7       | -40°C to +85°C    | 8-Lead SOIC_N, Standard Grade, 7" Tape and Reel,         | R-8            |          |
| AD8422ARZ-RL       | -40°C to +85°C    | 8-Lead SOIC_N, Standard Grade, 13" Tape and Reel         | R-8            |          |
| AD8422BRZ          | -40°C to +85°C    | 8-Lead SOIC_N, High Performance Grade                    | R-8            |          |
| AD8422BRZ-R7       | -40°C to +85°C    | 8-Lead SOIC_N, High Performance Grade, 7" Tape and Reel  | R-8            |          |
| AD8422BRZ-RL       | -40°C to +85°C    | 8-Lead SOIC_N, High Performance Grade, 13" Tape and Reel | R-8            |          |
| AD8422ARMZ         | -40°C to +85°C    | 8-Lead MSOP, Standard Grade                              | RM-8           | Y4U      |
| AD8422ARMZ-R7      | -40°C to +85°C    | 8-Lead MSOP, Standard Grade, 7" Tape and Reel,           | RM-8           | Y4U      |
| AD8422ARMZ-RL      | -40°C to +85°C    | 8-Lead MSOP, Standard Grade, 13" Tape and Reel           | RM-8           | Y4U      |
| AD8422BRMZ         | -40°C to +85°C    | 8-Lead MSOP, High Performance Grade                      | RM-8           | Y4V      |
| AD8422BRMZ-R7      | -40°C to +85°C    | 8-Lead MSOP, High Performance Grade, 7" Tape and Reel    | RM-8           | Y4V      |
| AD8422BRMZ-RL      | -40°C to +85°C    | 8-Lead MSOP, High Performance Grade, 13" Tape and Reel   | RM-8           | Y4V      |

<sup>1</sup> Z = RoHS Compliant Part.



Компания «Life Electronics» занимается поставками электронных компонентов импортного и отечественного производства от производителей и со складов крупных дистрибьюторов Европы, Америки и Азии.

С конца 2013 года компания активно расширяет линейку поставок компонентов по направлению коаксиальный кабель, кварцевые генераторы и конденсаторы (керамические, пленочные, электролитические), за счёт заключения дистрибьюторских договоров

Мы предлагаем:

- Конкурентоспособные цены и скидки постоянным клиентам.
- Специальные условия для постоянных клиентов.
- Подбор аналогов.
- Поставку компонентов в любых объемах, удовлетворяющих вашим потребностям.
- Приемлемые сроки поставки, возможна ускоренная поставка.
- Доставку товара в любую точку России и стран СНГ.
- Комплексную поставку.
- Работу по проектам и поставку образцов.
- Формирование склада под заказчика.
- Сертификаты соответствия на поставляемую продукцию (по желанию клиента).
- Тестирование поставляемой продукции.
- Поставку компонентов, требующих военную и космическую приемку.
- Входной контроль качества.
- Наличие сертификата ISO.

В составе нашей компании организован Конструкторский отдел, призванный помогать разработчикам, и инженерам.

Конструкторский отдел помогает осуществить:

- Регистрацию проекта у производителя компонентов.
- Техническую поддержку проекта.
- Защиту от снятия компонента с производства.
- Оценку стоимости проекта по компонентам.
- Изготовление тестовой платы монтаж и пусконаладочные работы.



Тел: +7 (812) 336 43 04 (многоканальный)

Email: [org@lifeelectronics.ru](mailto:org@lifeelectronics.ru)