

SK625xD Series

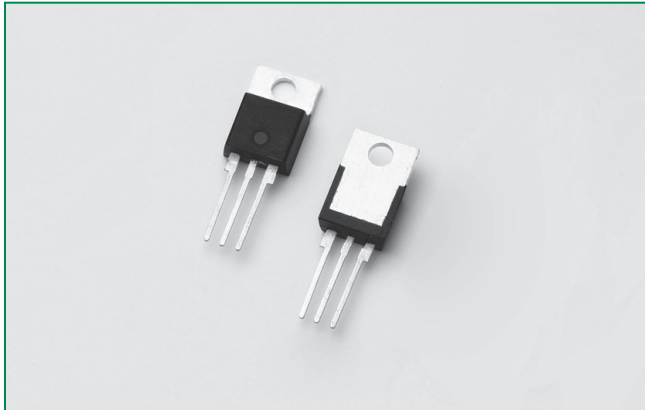

Description

Excellent unidirectional switches for phase control applications such as heating and motor speed controls. Standard phase control SCRs are triggered with few milliamperes of current at less than 1.5V potential.

Features & Benefits

- RoHS compliant
- Voltage capability up to 1600 V
- Surge capability up to 250 A
- Electrically isolated package "LD-Package" and UL recognized for 2500V_{RMS}

Applications

Typical applications are AC solid-state switches, industrial power tools, line rectification 50/60Hz. Internally constructed isolated packages are offered for ease of heat sinking with highest isolation voltage.

Agency Approval

Agency	Agency File Number
	E71639

Main Features

Symbol	Value	Unit
$I_{T(RMS)}$	25	A
V_{DRM}/V_{RRM}	1600	V
I_{GT}	35	mA

Schematic Symbol

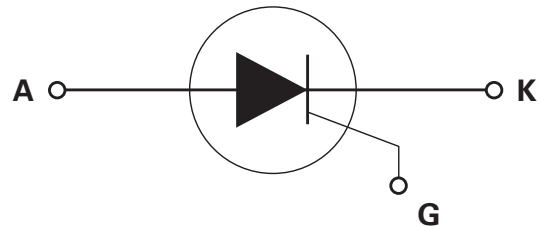

Absolute Maximum Ratings — 25A SCR

Symbol	Parameter	Test Conditions		Value	Unit
V_{DRM}/V_{RRM}	Repetitive Peak off-state/Reverse Voltage			1600	V
V_{DSM}/V_{RSM}	Non-repetitive peak off-state/Reverse voltage			1700	V
$I_{T(RMS)}$	RMS on-state current	SK625LD	$T_C = 60^\circ\text{C}$	25	A
		SK625RD	$T_C = 90^\circ\text{C}$		
$I_{T(AV)}$	Average on-state current	SK625LD	$T_C = 60^\circ\text{C}$	16	A
		SK625RD	$T_C = 90^\circ\text{C}$		
I_{TSM}	Peak non-repetitive surge current	single half cycle; f = 50Hz; T_J (initial) = 25°C		250	A
		single half cycle; f = 60Hz; T_J (initial) = 25°C		300	
I^2t	I^2t Value for fusing	$t_p = 8.3$ ms		375	A ² s
di/dt	Critical rate of rise of on-state current			100	A/ μ s
I_{GM}	Peak gate current	$T_J = 125^\circ\text{C}$		1.5	A
$P_{G(AV)}$	Average gate power dissipation	$T_J = 125^\circ\text{C}$		1	W
T_{stg}	Storage temperature range			-40 to 150	°C
T_J	Operating junction temperature range			-40 to 125	°C

Notes :
 x = package

Electrical Characteristics ($T_J = 25^\circ\text{C}$, unless otherwise specified)

Symbol	Test Conditions		Value	Unit
I_{GT}	$V_D = 12\text{V}; R_L = 30\Omega$	MAX.	35	mA
V_{GT}		MAX.	1.5	V
dv/dt	$V_D = 2/3 V_{DRM}$; gate open; $T_J = 125^\circ\text{C}$	MIN.	2000	V/ μ s
V_{GD}	$V_D = V_{DRM}$; $R_L = 3.3$ k Ω ; $T_J = 125^\circ\text{C}$	MIN.	0.2	V
I_H	$I_T = 500\text{mA}$ (initial)	MAX.	120	mA
t_q	$I_T = 0.5\text{A}$; $t_p = 50\mu\text{s}$; dv/dt=5V/ μ s; di/dt=-30A/ μ s	TYP.	25	μ s
t_{gt}	$I_G = 2 \times I_{GT}$; PW = 15 μ s; $I_T = 50\text{A}$	TYP.	5	μ s

Notes :
 x = package

Static Characteristics

Symbol	Test Conditions		Value	Unit	
V_{TM}	$I_T = 50\text{A}$; $t_p = 380\mu\text{s}$	MAX.	1.8	V	
I_{DRM}/I_{RRM}	V_{DRM}/V_{RRM}	$T_J = 25^\circ\text{C}$	MAX.	10	μ A
		$T_J = 125^\circ\text{C}$		4	mA

Thermal Resistances

Symbol	Parameter	Value	Unit
$R_{\theta(J-C)}$	Junction to case (AC)	SK625RD	1.0
		SK625LD	1.9

Figure 1: Normalized DC Gate Trigger Current vs. Junction Temperature

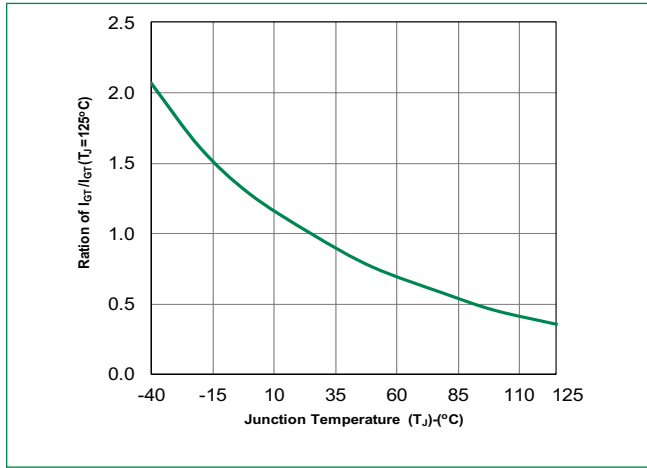

Figure 2: Normalized DC Gate Trigger Voltage vs. Junction Temperature

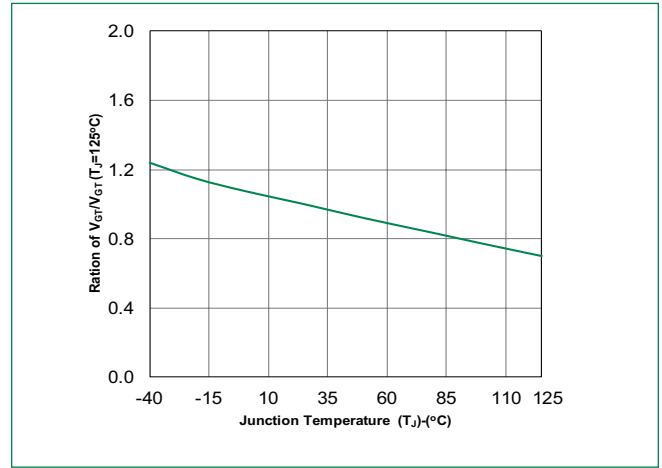

Figure 3: Normalized DC Holding Current vs. Junction Temperature

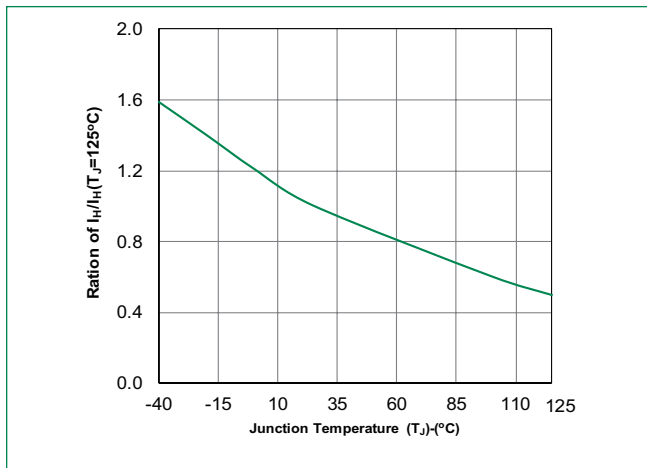

Figure 4: On-State Current vs. On-State Voltage (Typical)

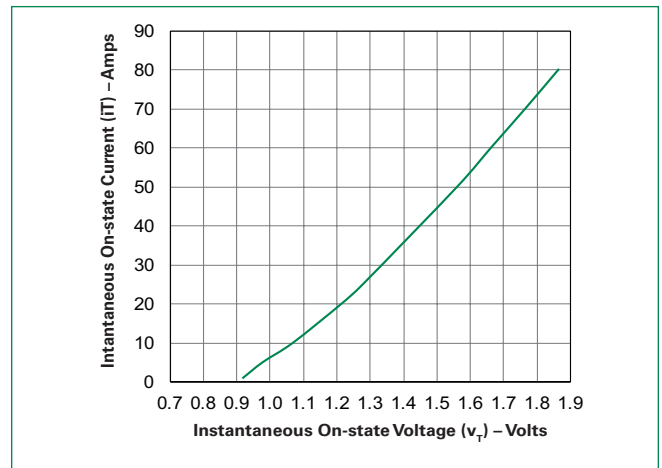

Figure 5: Power Dissipation (Typical) vs. RMS On-State Current

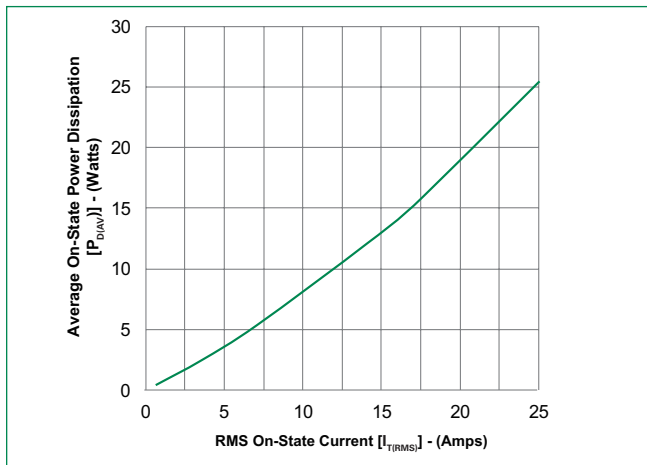

Figure 6: Maximum Allowable Case Temperature vs. RMS On-State Current

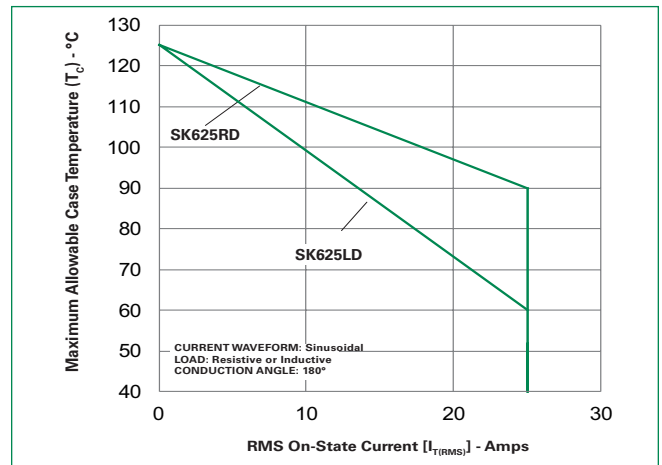

Figure 7: Maximum Allowable Case Temperature vs. Average On-State Current

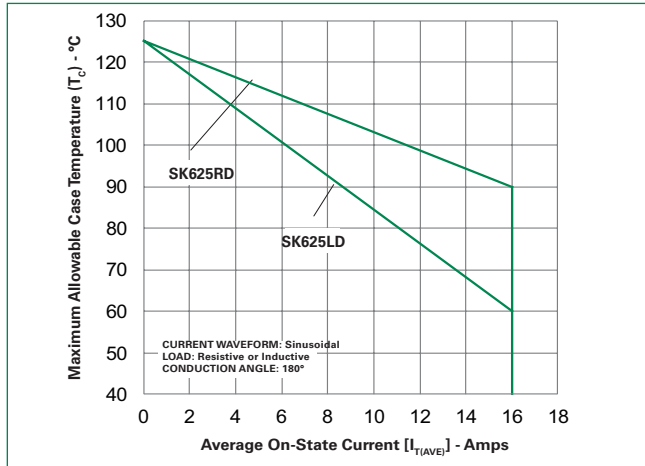
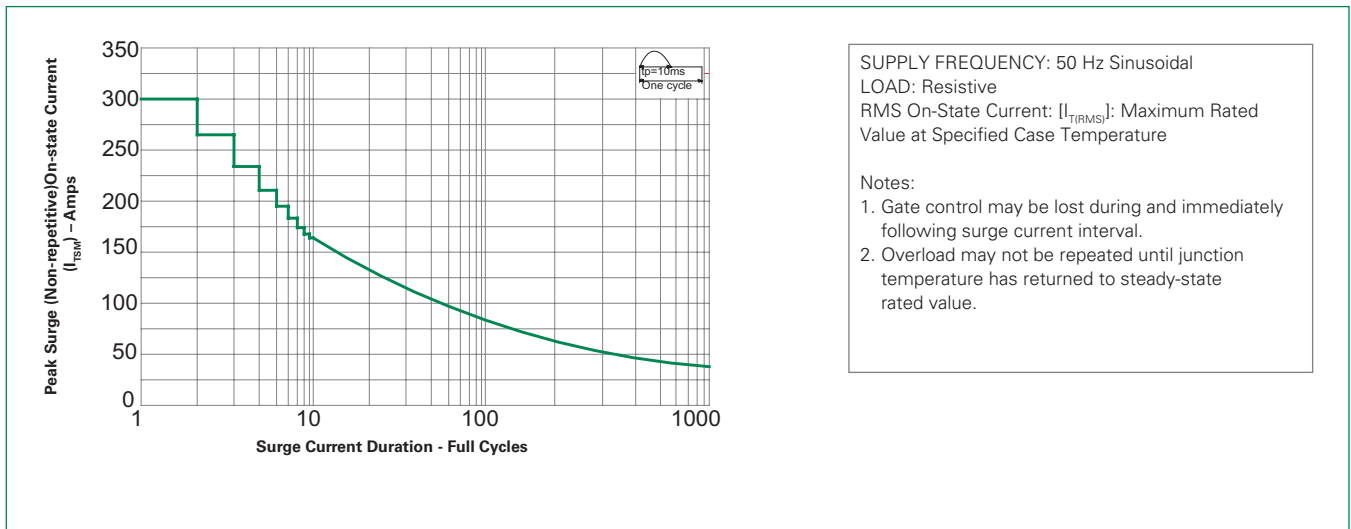

Figure 8: Surge Peak On-State Current vs. Number of Cycles



Environmental Specifications

Test	Specifications and Conditions
AC Blocking	JESD22-A108C, 80% V _{DRM} @125°C for 168 hours
Temperature Cycling	MIL-STD-750, M-1051, 100 cycles; -40°C to +150°C; 15-min dwell-time
Temperature/Humidity	EIA / JEDEC, JESD22-A101 168 hours; 100V - DC: 85°C; 85% rel humidity
Resistance to Solder Heat	JESD22-B106C
Solderability	J-STD-022, category 3, test A

Design Considerations

Careful selection of the correct device for the application's operating parameters and environment will go a long way toward extending the operating life of the Thyristor. Good design practice should limit the maximum continuous current through the main terminals to 75% of the device rating. Other ways to ensure long life for a power discrete semiconductor are proper heat sinking and selection of voltage ratings for worst case conditions. Overheating, overvoltage (including dv/dt), and surge currents are the main killers of semiconductors. Correct mounting, soldering, and forming of the leads also help protect against component damage.

Dimensions — TO-220AB (RD-Package) — Non-Isolated Mounting Tab Common with Center Lead

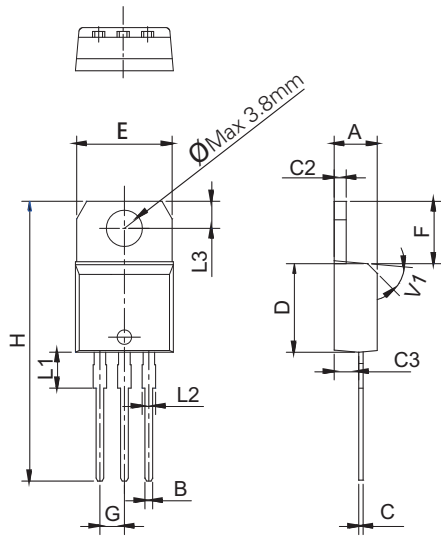

Note: Maximum torque to be applied to mounting tab is 3 in-lbs (0.3Nm).

Dimension	Millimeters			Inches		
	Min.	Typ.	Max.	Min.	Typ.	Max.
A	4.40		4.60	0.173		0.181
B	0.61		0.88	0.024		0.035
C	0.46		0.70	0.018		0.028
C2	1.21		1.32	0.048		0.052
C3	2.40		2.72	0.094		0.107
D	8.60		9.70	0.339		0.382
E	9.60		10.4	0.378		0.409
F	6.20		6.60	0.244		0.260
G		2.54			0.1	
H	28.0		29.8	1.102		1.173
L1		3.75			0.148	
L2	1.14		1.70	0.045		0.067
L3	2.65		2.95	0.104		0.116
V1		45°			45°	

Dimensions — TO-220AB (LD-Package) — Isolated Mounting Tab

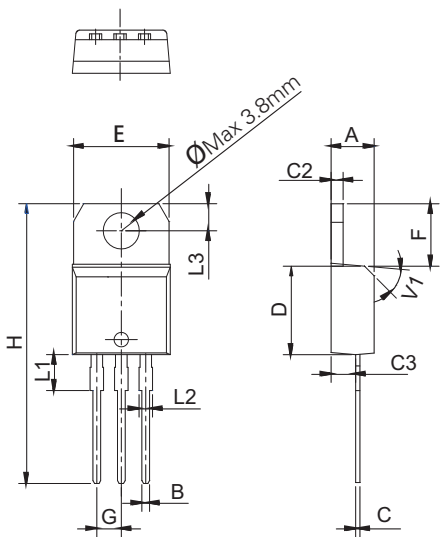

Note: Maximum torque to be applied to mounting tab is 7 in-lbs. (0.8 Nm).

Dimension	Millimeters			Inches		
	Min.	Typ.	Max.	Min.	Typ.	Max.
A	4.40		4.60	0.173		0.181
B	0.61		0.88	0.024		0.035
C	0.46		0.70	0.018		0.028
C2	1.21		1.32	0.048		0.052
C3	2.40		2.72	0.094		0.107
D	8.60		9.70	0.339		0.382
E	9.80		10.4	0.386		0.409
F	6.55		6.95	0.258		0.274
G		2.54			0.1	
H	28.0		29.8	1.102		1.173
L1		3.75			0.148	
L2	1.14		1.70	0.045		0.067
L3	2.65		2.95	0.104		0.116
V1		45°			45°	

Product Selector

Part Number	Gate Sensitivity	Type	Package
SK625LD	35mA	Standard SCR	TO-220L
SK625RD	35mA	Standard SCR	TO-220R

Packing Options

Part Number	Marking	Weight	Packing Mode	Base Quantity
SK625LDTP	SK625LD	2.2g	Tube	1000
SK625RDTP	SK625RD	2.0g	Tube	1000

Part Numbering System

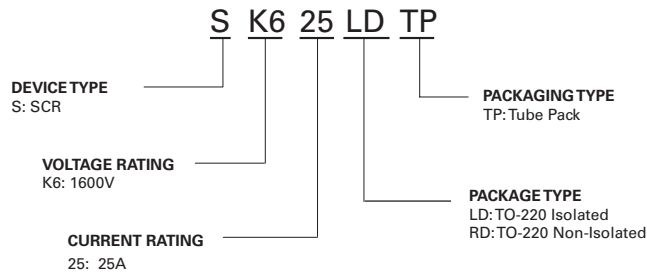

Part Marking System

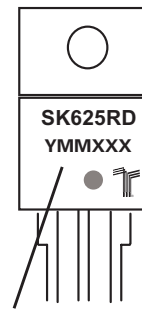

Date Code Marking
 Y: Year Code
 MM: Month Code
 XXX: Lot Trace Code

Компания «Life Electronics» занимается поставками электронных компонентов импортного и отечественного производства от производителей и со складов крупных дистрибьюторов Европы, Америки и Азии.

С конца 2013 года компания активно расширяет линейку поставок компонентов по направлению коаксиальный кабель, кварцевые генераторы и конденсаторы (керамические, пленочные, электролитические), за счёт заключения дистрибьюторских договоров

Мы предлагаем:

- Конкурентоспособные цены и скидки постоянным клиентам.
- Специальные условия для постоянных клиентов.
- Подбор аналогов.
- Поставку компонентов в любых объемах, удовлетворяющих вашим потребностям.
- Приемлемые сроки поставки, возможна ускоренная поставка.
- Доставку товара в любую точку России и стран СНГ.
- Комплексную поставку.
- Работу по проектам и поставку образцов.
- Формирование склада под заказчика.
- Сертификаты соответствия на поставляемую продукцию (по желанию клиента).
- Тестирование поставляемой продукции.
- Поставку компонентов, требующих военную и космическую приемку.
- Входной контроль качества.
- Наличие сертификата ISO.

В составе нашей компании организован Конструкторский отдел, призванный помогать разработчикам, и инженерам.

Конструкторский отдел помогает осуществить:

- Регистрацию проекта у производителя компонентов.
- Техническую поддержку проекта.
- Защиту от снятия компонента с производства.
- Оценку стоимости проекта по компонентам.
- Изготовление тестовой платы монтаж и пусконаладочные работы.



Тел: +7 (812) 336 43 04 (многоканальный)
Email: org@lifeelectronics.ru