

Standard type:  (AQV256) / Reinforced type:  (AQV253H, AQV254H)   (AQV256H)

**DIP6-pin type with
low on-resistance and
reinforced insulation**

**PhotoMOS[®]
HE 1 Form A
(AQV250, AQV250H)**



RoHS compliant

FEATURES

1. Wide variation of 40V, 60V, 100V, 200V, 250V, 400V, 600V, 1,000V and 1,500V load voltage
2. Low on-resistance of Typ. 0.6Ω (AQV251)
3. Reinforced insulation type of 5,000Vrms I/O isolation available

TYPICAL APPLICATIONS

- Measuring instruments
- Data communication equipment
- Telephone equipment
- Automatic meter reading device

TYPES

	I/O isolation	Output rating*		Package	Part No.				Packing quantity	
					Through hole terminal	Surface-mount terminal			Tube	Tape and reel
						Tube packing style		Tape and reel packing style		
		Load voltage	Load current			Picked from the 1/2/3-pin side	Picked from the 4/5/6-pin side			
AC/DC dual use	1,500Vrms	40 V	500 mA	DIP6-pin	AQV251	AQV251A	AQV251AX	AQV251AZ	1 tube contains: 50 pcs. 1 batch contains: 500 pcs.	1,000 pcs.
		60 V	400 mA		AQV252	AQV252A	AQV252AX	AQV252AZ		
		100 V	350 mA		AQV255	AQV255A	AQV255AX	AQV255AZ		
		200 V	250 mA		AQV257	AQV257A	AQV257AX	AQV257AZ		
		250 V	200 mA		AQV253	AQV253A	AQV253AX	AQV253AZ		
		400 V	150 mA		AQV254	AQV254A	AQV254AX	AQV254AZ		
		1,000 V	30 mA		AQV259	AQV259A	AQV259AX	AQV259AZ		
		1,500 V	20 mA		AQV258	AQV258A	AQV258AX	AQV258AZ		
	Reinforced 5,000Vrms	250 V	200 mA		AQV253H	AQV253HA	AQV253HAX	AQV253HAZ		
		400 V	150 mA		AQV254H	AQV254HA	AQV254HAX	AQV254HAZ		
		600 V	130 mA		AQV256H	AQV256HA	AQV256HAX	AQV256HAZ		

*Indicate the peak AC and DC values.

Note: The surface mount terminal indicator "A" and the packing style indicator "X" or "Z" are not marked on the device.

RATING

1. Absolute maximum ratings (Ambient temperature: 25°C 77°F)

Item	Sym- bol	Type of connec- tion	AQV251(A)	AQV252(A)	AQV255(A)	AQV257(A)	AQV253(A)	AQV254(A)	AQV259(A)	AQV258(A)	AQV253H(A)	AQV254H(A)	AQV256H(A)	Remarks
LED forward current	I_F		50 mA											
LED reverse voltage	V_R		5 V											
Peak forward current	I_{FP}		1 A											f = 100 Hz, Duty factor +0.1%
Power dissipation	P_{in}		75 mW											
Load voltage (peak AC)	V_L		40V	60V	100V	200V	250V	400V	1,000V	1,500V	250V	400V	600V	
Continuous load current	I_L	A	0.5A	0.4A	0.35A	0.25A	0.2A	0.15A	0.03A	0.02A	0.2A	0.15A	0.13A	A connection: Peak AC, DC B, C connection: DC
		B	0.7A	0.6A	0.45A	0.35A	0.3A	0.18A	0.04A	0.025A	0.3A	0.18A	0.14A	
		C	1.0A	0.8A	0.70A	0.5A	0.4A	0.25A	0.05A	0.04A	0.4A	0.25A	0.16A	
Peak load current	I_{peak}		1.8A	1.5A	1.0A	0.75A	0.6A	0.5A	0.09A	0.06A	0.6A	0.5A	0.4A	A connection: 100 ms (1 shot) $V_L = DC$
Power dissipation	P_{out}		360 mW											
Total power dissipation	P_T		410 mW											
I/O isolation voltage	V_{iso}		1,500 Vrms						5,000 Vrms					
Ambient temperature	Operating	T_{opr}	-40 to +85°C -40 to +185°F											(Non-icing at low temperatures)
	Storage	T_{stg}	-40 to +100°C -40 to +212°F											

2. Electrical characteristics (Ambient temperature: 25°C 77°F)

Item	Sym- bol	Type of connec- tion	AQV251(A)	AQV252(A)	AQV255(A)	AQV257(A)	AQV253(A)	AQV254(A)	AQV259(A)	AQV258(A)	AQV253H(A)	AQV254H(A)	AQV256H(A)	Condition		
Input	LED operate current	Typical	0.9 mA						1.4 mA					$I_L = \text{Max.}$		
		Maximum	3 mA													
	LED turn off current	Minimum	0.4 mA											$I_L = \text{Max.}$		
		Typical	0.8 mA						1.3 mA							
LED dropout voltage	Typical	V_F	1.25 V (1.14 V at $I_F = 5 \text{ mA}$)											$I_F = 50 \text{ mA}$		
	Maximum		1.5 V													
Output	On resistance	Typical	R_{on}	A	0.6 Ω	0.74 Ω	1.8 Ω	2.6 Ω	5.5 Ω	12.4 Ω	85 Ω	345 Ω	5.5 Ω	12.4 Ω	20 Ω	$I_F = 5 \text{ mA}$ $I_L = \text{Max.}$ Within 1 s
					Maximum	1 Ω	1.4 Ω	2.5 Ω	4 Ω	8 Ω	16 Ω	200 Ω	500 Ω	8 Ω	16 Ω	
		Typical	R_{on}	B	0.3 Ω	0.37 Ω	0.9 Ω	1.4 Ω	2.7 Ω	6.2 Ω	60 Ω	345 Ω	2.7 Ω	6.2 Ω	15 Ω	
					Maximum	0.5 Ω	0.7 Ω	1.25 Ω	2 Ω	4 Ω	8 Ω	100 Ω	500 Ω	4 Ω	8 Ω	
	Typical	R_{on}	C	0.15 Ω	0.18 Ω	0.45 Ω	0.7 Ω	1.4 Ω	3.1 Ω	30 Ω	160 Ω	1.4 Ω	3.1 Ω	7.5 Ω	$I_F = 5 \text{ mA}$ $I_L = \text{Max.}$ Within 1 s	
				Maximum	0.25 Ω	0.35 Ω	0.63 Ω	1 Ω	2 Ω	4 Ω	50 Ω	250 Ω	2 Ω	4 Ω		10 Ω
Off state leakage current	Maximum	I_{Leak}		1 μA						10 μA		1 μA		$I_F = 0 \text{ mA}$ $V_L = \text{Max.}$		
Transfer characteristics	Turn on time*	Typical	T_{on}	1.7 ms	1.4 ms	0.9 ms	1.5 ms	0.8 ms	0.6 ms	0.35 ms	2.4 ms	1.8 ms	1.2 ms	$I_F = 5 \text{ mA}$ $I_L = \text{Max.}$		
		Maximum		3 ms	2 ms	3 ms	2 ms	1 ms	4 ms	3ms						
	Turn off time*	Typical	T_{off}		0.07 ms	0.09 ms	0.1 ms	0.06 ms	0.05 ms	0.04 ms	0.06 ms	0.05 ms	0.06 ms	$I_F = 5 \text{ mA}$ $I_L = \text{Max.}$		
		Maximum		0.2 ms												
	I/O capacitance	Typical	C_{iso}		1.3 pF											f = 1 MHz $V_B = 0 \text{ V}$
Maximum				3 pF												
Initial I/O isolation resistance	Minimum	R_{iso}		1,000 MΩ											500 V DC	

*Turn on/Turn off time



3. Recommended operating conditions (Ambient temperature: 25°C 77°F)

Please use under recommended operating conditions to obtain expected characteristics.

	Item	Symbol	Min.	Max.	Unit
	LED current	I _F	5	30	mA
AQV251(A)	Load voltage (Peak AC)	V _L	—	32	V
	Continuous load current (A connection)	I _L	—	0.5	A
AQV252(A)	Load voltage (Peak AC)	V _L	—	48	V
	Continuous load current (A connection)	I _L	—	0.4	A
AQV255(A)	Load voltage (Peak AC)	V _L	—	80	V
	Continuous load current (A connection)	I _L	—	0.35	A
AQV257(A)	Load voltage (Peak AC)	V _L	—	160	V
	Continuous load current (A connection)	I _L	—	0.25	A
AQV253(A)	Load voltage (Peak AC)	V _L	—	200	V
	Continuous load current (A connection)	I _L	—	0.2	A
AQV254(A)	Load voltage (Peak AC)	V _L	—	320	V
	Continuous load current (A connection)	I _L	—	0.15	A
AQV259(A)	Load voltage (Peak AC)	V _L	—	800	V
	Continuous load current (A connection)	I _L	—	0.03	A
AQV258(A)	Load voltage (Peak AC)	V _L	—	1200	V
	Continuous load current (A connection)	I _L	—	0.02	A
AQV253H(A)	Load voltage (Peak AC)	V _L	—	200	V
	Continuous load current (A connection)	I _L	—	0.2	A
AQV254H(A)	Load voltage (Peak AC)	V _L	—	320	V
	Continuous load current (A connection)	I _L	—	0.15	A
AQV256H(A)	Load voltage (Peak AC)	V _L	—	480	V
	Continuous load current (A connection)	I _L	—	0.13	A

■ **These products are not designed for automotive use.**

If you are considering to use these products for automotive applications, please contact your local Panasonic Corporation technical representative.

■ **Continual DC bias (for AQV258**, AQV259**)**

In cases in which a continual DC bias is applied between the input and output, the output-side MOS-FET may deteriorate due to the voltage. Therefore, please verify operation of the actual design before using. An example of a circuit that might undergo MOS-FET deterioration due to voltage is given below.

REFERENCE DATA

1.-(1) Load current vs. ambient temperature characteristics

Allowable ambient temperature: -40 to +85°C
-40 to +185°F ;

Type of connection: A



1.-(2) Load current vs. ambient temperature characteristics

Allowable ambient temperature: -40 to +85°C
-40 to +185°F ;

Type of connection: A



2.-(1) On resistance vs. ambient temperature characteristics

Measured portion: between terminals 4 and 6;
LED current: 5 mA;
Continuous load current: Max. (DC)



2.-(2) On resistance vs. ambient temperature characteristics

Measured portion: between terminals 4 and 6;
LED current: 5 mA;
Continuous load current: Max. (DC)



2.-(3) On resistance vs. ambient temperature characteristics

Measured portion: between terminals 4 and 6;
LED current: 5 mA;
Continuous load current: 30 mA (DC)



3.-(1) Turn on time vs. ambient temperature characteristics

LED current: 5 mA;
Load voltage: Max. (DC);
Continuous load current: Max. (DC)



HE 1 Form A (AQV250, AQV250H)

3.-(2) Turn on time vs. ambient temperature characteristics

LED current: 5 mA; Load voltage: Max. (DC);
Continuous load current: Max. (DC)



4.-(1) Turn off time vs. ambient temperature characteristics

LED current: 5 mA; Load voltage: Max. (DC);
Continuous load current: Max. (DC)



4.-(2) Turn off time vs. ambient temperature characteristics

Sample: AQV253H, AQV254H, AQV256H
LED current: 5 mA; Load voltage: Max. (DC);
Continuous load current: Max. (DC)



5.-(1) LED operate current vs. ambient temperature characteristics

Sample: AQV251, AQV252, AQV253, AQV254, AQV255, AQV257, AQV258, AQV259; Load voltage: Max. (DC); Continuous load current: Max. (DC)



5.-(2) LED operate current vs. ambient temperature characteristics

Sample: AQV253H, AQV254H, AQV256H; Load voltage: Max. (DC); Continuous load current: Max. (DC)



6.-(1) LED turn off current vs. ambient temperature characteristics

Sample: AQV251, AQV252, AQV253, AQV254, AQV255, AQV257, AQV258, AQV259; Load voltage: Max. (DC); Continuous load current: Max. (DC)



6.-(2) LED turn off current vs. ambient temperature characteristics

Sample: AQV253H, AQV254H, AQV256H; Load voltage: Max. (DC); Continuous load current: Max. (DC)

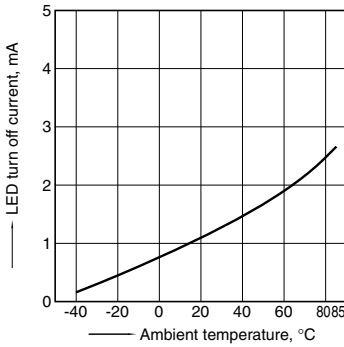

7. LED dropout voltage vs. ambient temperature characteristics

LED current: 5 to 50 mA



8.-(1) Current vs. voltage characteristics of output at MOS portion

Measured portion: between terminals 4 and 6;
Ambient temperature: 25°C 77°F



8.-(2) Current vs. voltage characteristics of output at MOS portion

Measured portion: between terminals 4 and 6;
Ambient temperature: 25°C 77°F



9.-(1) Off state leakage current vs. load voltage characteristics

Sample: AQV259; Measured portion: between terminals 4 and 6;
Ambient temperature: 25°C 77°F



9.-(2) Off state leakage current vs. load voltage characteristics

Measured portion: between terminals 4 and 6;
Ambient temperature: 25°C 77°F



10-(1). Turn on time vs. LED forward current characteristics

Measured portion: between terminals 4 and 6;
Load voltage: Max. (DC); Continuous load current: Max. (DC); Ambient temperature: 25°C 77°F



10-(2). Turn on time vs. LED forward current characteristics

Measured portion: between terminals 4 and 6;
Load voltage: Max. (DC); Continuous load current: Max. (DC); Ambient temperature: 25°C 77°F



11-(1). Turn off time vs. LED forward current characteristics

Measured portion: between terminals 4 and 6;
Load voltage: Max. (DC); Continuous load current: Max. (DC); Ambient temperature: 25°C 77°F



11-(2). Turn off time vs. LED forward current characteristics

Measured portion: between terminals 4 and 6;
Load voltage: Max. (DC); Continuous load current: Max. (DC); Ambient temperature: 25°C 77°F



12-(1) Output capacitance vs. applied voltage characteristics

Measured portion: between terminals 4 and 6;
Frequency: 1 MHz;
Ambient temperature: 25°C 77°F



12-(2) Output capacitance vs. applied voltage characteristics

Sample: AQV259;
Measured portion: between terminals 4 and 6;
Frequency: 1 MHz; Ambient temperature: 25°C 77°F



"PhotoMOS®", "PhotoMOS" and "PHOTOMOS" are registered trademarks of Panasonic Corporation.

*Recognized in Japan, the United States, all member states of European Union and other countries.

Please contact

Panasonic Corporation

Electromechanical Control Business Division

■ 1006, Oaza Kadoma, Kadoma-shi, Osaka 571-8506, Japan
industrial.panasonic.com/ac/e/

Panasonic®

©Panasonic Corporation 2017

Mouser Electronics

Authorized Distributor

Click to View Pricing, Inventory, Delivery & Lifecycle Information:

Panasonic:

[AQV252](#) [AQV252A](#) [AQV253](#) [AQV254A](#) [AQV254H](#) [AQV257](#) [AQV257A](#) [AQV258A](#) [AQV259A](#) [AQV258AX](#)
[AQV259](#) [AQV253H](#) [AQV258](#) [AQV254](#)

Компания «Life Electronics» занимается поставками электронных компонентов импортного и отечественного производства от производителей и со складов крупных дистрибьюторов Европы, Америки и Азии.

С конца 2013 года компания активно расширяет линейку поставок компонентов по направлению коаксиальный кабель, кварцевые генераторы и конденсаторы (керамические, пленочные, электролитические), за счёт заключения дистрибьюторских договоров

Мы предлагаем:

- Конкурентоспособные цены и скидки постоянным клиентам.
- Специальные условия для постоянных клиентов.
- Подбор аналогов.
- Поставку компонентов в любых объемах, удовлетворяющих вашим потребностям.
- Приемлемые сроки поставки, возможна ускоренная поставка.
- Доставку товара в любую точку России и стран СНГ.
- Комплексную поставку.
- Работу по проектам и поставку образцов.
- Формирование склада под заказчика.
- Сертификаты соответствия на поставляемую продукцию (по желанию клиента).
- Тестирование поставляемой продукции.
- Поставку компонентов, требующих военную и космическую приемку.
- Входной контроль качества.
- Наличие сертификата ISO.

В составе нашей компании организован Конструкторский отдел, призванный помогать разработчикам, и инженерам.

Конструкторский отдел помогает осуществить:

- Регистрацию проекта у производителя компонентов.
- Техническую поддержку проекта.
- Защиту от снятия компонента с производства.
- Оценку стоимости проекта по компонентам.
- Изготовление тестовой платы монтаж и пусконаладочные работы.



Тел: +7 (812) 336 43 04 (многоканальный)

Email: org@lifeelectronics.ru