



Is Now Part of



**ON Semiconductor®**

To learn more about ON Semiconductor, please visit our website at  
[www.onsemi.com](http://www.onsemi.com)

Please note: As part of the Fairchild Semiconductor integration, some of the Fairchild orderable part numbers will need to change in order to meet ON Semiconductor's system requirements. Since the ON Semiconductor product management systems do not have the ability to manage part nomenclature that utilizes an underscore (\_), the underscore (\_) in the Fairchild part numbers will be changed to a dash (-). This document may contain device numbers with an underscore (\_). Please check the ON Semiconductor website to verify the updated device numbers. The most current and up-to-date ordering information can be found at [www.onsemi.com](http://www.onsemi.com). Please email any questions regarding the system integration to [Fairchild\\_questions@onsemi.com](mailto:Fairchild_questions@onsemi.com).

ON Semiconductor and the ON Semiconductor logo are trademarks of Semiconductor Components Industries, LLC dba ON Semiconductor or its subsidiaries in the United States and/or other countries. ON Semiconductor owns the rights to a number of patents, trademarks, copyrights, trade secrets, and other intellectual property. A listing of ON Semiconductor's product/patent coverage may be accessed at [www.onsemi.com/site/pdf/Patent-Marking.pdf](http://www.onsemi.com/site/pdf/Patent-Marking.pdf). ON Semiconductor reserves the right to make changes without further notice to any products herein. ON Semiconductor makes no warranty, representation or guarantee regarding the suitability of its products for any particular purpose, nor does ON Semiconductor assume any liability arising out of the application or use of any product or circuit, and specifically disclaims any and all liability, including without limitation special, consequential or incidental damages. Buyer is responsible for its products and applications using ON Semiconductor products, including compliance with all laws, regulations and safety requirements or standards, regardless of any support or applications information provided by ON Semiconductor. "Typical" parameters which may be provided in ON Semiconductor data sheets and/or specifications can and do vary in different applications and actual performance may vary over time. All operating parameters, including "Typicals" must be validated for each customer application by customer's technical experts. ON Semiconductor does not convey any license under its patent rights nor the rights of others. ON Semiconductor products are not designed, intended, or authorized for use as a critical component in life support systems or any FDA Class 3 medical devices or medical devices with a same or similar classification in a foreign jurisdiction or any devices intended for implantation in the human body. Should Buyer purchase or use ON Semiconductor products for any such unintended or unauthorized application, Buyer shall indemnify and hold ON Semiconductor and its officers, employees, subsidiaries, affiliates, and distributors harmless against all claims, costs, damages, and expenses, and reasonable attorney fees arising out of, directly or indirectly, any claim of personal injury or death associated with such unintended or unauthorized use, even if such claim alleges that ON Semiconductor was negligent regarding the design or manufacture of the part. ON Semiconductor is an Equal Opportunity/Affirmative Action Employer. This literature is subject to all applicable copyright laws and is not for resale in any manner.



## FSGM0565RB Green-Mode Fairchild Power Switch (FPS™)

### Features

- Soft Burst-Mode Operation for Low Standby Power Consumption and Low Noise
- Precision Fixed Operating Frequency: 66kHz
- Pulse-by-Pulse Current Limit
- Various Protection Functions: Overload Protection (OLP), Over-Voltage Protection (OVP), Abnormal Over-Current Protection (AOCP), Internal Thermal Shutdown (TSD) with Hysteresis, Output-Short Protection (OSP), and Under-Voltage Lockout (UVLO) with Hysteresis
- Auto-Restart Mode
- Internal Startup Circuit
- Internal High-Voltage SenseFET: 650V
- Built-in Soft-Start: 15ms

### Description

The FSGM0565RB is an integrated Pulse Width Modulation (PWM) controller and SenseFET specifically designed for offline Switch-Mode Power Supplies (SMPS) with minimal external components. The PWM controller includes an integrated fixed-frequency oscillator, Under-Voltage Lockout (UVLO), Leading-Edge Blanking (LEB), optimized gate driver, internal soft-start, temperature-compensated precise current sources for loop compensation, and self-protection circuitry. Compared with a discrete MOSFET and PWM controller solution, the FSGM series can reduce total cost, component count, size, and weight; while simultaneously increasing efficiency, productivity, and system reliability. This device provides a basic platform suited for cost-effective design of a flyback converter.

### Applications

- Power Supply for LCD TV and Monitor, STB and DVD Combination

### Ordering Information

Part Number	Package	Operating Junction Temperature	Current Limit	R <sub>DS(ON)</sub> (Max.)	Output Power Table <sup>(2)</sup>				Replaces Device
					230V <sub>AC</sub> ± 15% <sup>(3)</sup>		85-265V <sub>AC</sub>		
					Adapter <sup>(4)</sup>	Open Frame <sup>(5)</sup>	Adapter <sup>(4)</sup>	Open Frame <sup>(5)</sup>	
FSGM0565RBWDTU	TO-220F 6-Lead <sup>(1)</sup> W-Forming	-40°C ~ +125°C	3.00A	2.2Ω	70W	80W	41W	60W	FSDM0565RE
FSGM0565RBUDTU	TO-220F 6-Lead <sup>(1)</sup> U-Forming	-40°C ~ +125°C	3.00A	2.2Ω	70W	80W	41W	60W	FSDM0565RE
FSGM0565RBLDTU	TO-220F 6-Lead <sup>(1)</sup> L-Forming	-40°C ~ +125°C	3.00A	2.2Ω	70W	80W	41W	60W	FSDM0565RE

#### Notes:

1. Pb-free package per JEDEC J-STD-020B.
2. The junction temperature can limit the maximum output power.
3. 230V<sub>AC</sub> or 100/115V<sub>AC</sub> with voltage doubler.
4. Typical continuous power in a non-ventilated enclosed adapter measured at 50°C ambient temperature.
5. Maximum practical continuous power in an open-frame design at 50°C ambient temperature.



## Pin Configuration

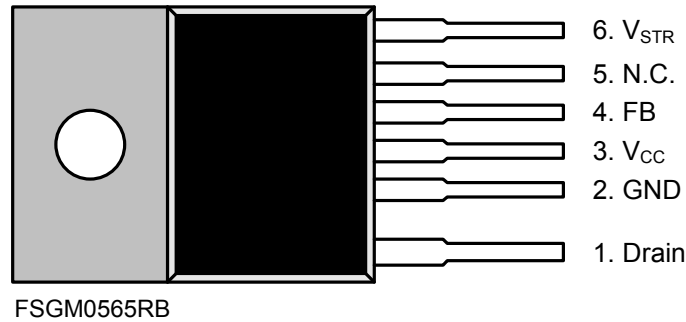

Figure 3. Pin Configuration (Top View)

## Pin Definitions

Pin #	Name	Description
1	Drain	<b>SenseFET Drain.</b> High-voltage power SenseFET drain connection.
2	GND	<b>Ground.</b> This pin is the control ground and the SenseFET source.
3	V <sub>CC</sub>	<b>Power Supply.</b> This pin is the positive supply input, which provides the internal operating current for both startup and steady-state operation.
4	FB	<b>Feedback.</b> This pin is internally connected to the inverting input of the PWM comparator. The collector of an opto-coupler is typically tied to this pin. For stable operation, a capacitor should be placed between this pin and GND. If the voltage of this pin reaches 6V, the overload protection triggers, which shuts down the FPS.
5	N.C.	No Connection.
6	V <sub>STR</sub>	<b>Startup.</b> This pin is connected directly, or through a resistor, to the high-voltage DC link. At startup, the internal high-voltage current source supplies internal bias and charges the external capacitor connected to the V <sub>CC</sub> pin. Once V <sub>CC</sub> reaches 12V, the internal current source (I <sub>CH</sub> ) is disabled.

## Absolute Maximum Ratings

Stresses exceeding the absolute maximum ratings may damage the device. The device may not function or be operable above the recommended operating conditions and stressing the parts to these levels is not recommended. In addition, extended exposure to stresses above the recommended operating conditions may affect device reliability. The absolute maximum ratings are stress ratings only.

Symbol	Parameter		Min.	Max.	Unit
V <sub>STR</sub>	V <sub>STR</sub> Pin Voltage			650	V
V <sub>DS</sub>	Drain Pin Voltage			650	V
V <sub>CC</sub>	V <sub>CC</sub> Pin Voltage			26	V
V <sub>FB</sub>	Feedback Pin Voltage		-0.3	12.0	V
I <sub>DM</sub>	Drain Current Pulsed			11	A
I <sub>DS</sub>	Continuous Switching Drain Current <sup>(6)</sup>	T <sub>C</sub> =25°C		5.6	A
		T <sub>C</sub> =100°C		3.4	A
E <sub>AS</sub>	Single Pulsed Avalanche Energy <sup>(7)</sup>			295	mJ
P <sub>D</sub>	Total Power Dissipation (T <sub>C</sub> =25°C) <sup>(8)</sup>			45	W
T <sub>J</sub>	Maximum Junction Temperature			150	°C
	Operating Junction Temperature <sup>(9)</sup>		-40	+125	°C
T <sub>STG</sub>	Storage Temperature		-55	+150	°C
V <sub>ISO</sub>	Minimum Isolation Voltage <sup>(10)</sup>		2.5		kV
ESD	Electrostatic Discharge Capability	Human Body Model, JESD22-A114	2		kV
		Charged Device Model, JESD22-C101	2		

### Notes:

6. Repetitive peak switching current when the inductive load is assumed: Limited by maximum duty (D<sub>MAX</sub>=0.75) and junction temperature (see Figure 4).
7. L=45mH, starting T<sub>J</sub>=25°C.
8. Infinite cooling condition (refer to the SEMI G30-88).
9. Although this parameter guarantees IC operation, it does not guarantee all electrical characteristics.
10. The voltage between the package back side and the lead is guaranteed.

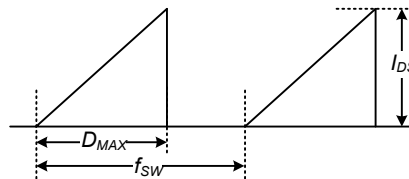

Figure 4. Repetitive Peak Switching Current

## Thermal Impedance

T<sub>A</sub>=25°C unless otherwise specified.

Symbol	Parameter	Value	Unit
θ <sub>JA</sub>	Junction-to-Ambient Thermal Impedance <sup>(11)</sup>	62.5	°C/W
θ <sub>JC</sub>	Junction-to-Case Thermal Impedance <sup>(12)</sup>	3	°C/W

### Notes:

11. Infinite cooling condition (refer to the SEMI G30-88).
12. Free standing with no heat-sink under natural convection.

**Electrical Characteristics**T<sub>J</sub> = 25°C unless otherwise specified.

Symbol	Parameter	Conditions	Min.	Typ.	Max.	Unit
<b>SenseFET Section</b>						
BV <sub>DSS</sub>	Drain-Source Breakdown Voltage	V <sub>CC</sub> = 0V, I <sub>D</sub> = 250μA	650			V
I <sub>DSS</sub>	Zero-Gate-Voltage Drain Current	V <sub>DS</sub> = 520V, T <sub>A</sub> = 125°C			250	μA
R <sub>DS(ON)</sub>	Drain-Source On-State Resistance	V <sub>GS</sub> = 10V, I <sub>D</sub> = 1A		1.8	2.2	Ω
C <sub>ISS</sub>	Input Capacitance <sup>(13)</sup>	V <sub>DS</sub> = 25V, V <sub>GS</sub> = 0V, f=1MHz		515		pF
C <sub>OSS</sub>	Output Capacitance <sup>(13)</sup>	V <sub>DS</sub> = 25V, V <sub>GS</sub> = 0V, f=1MHz		75		pF
t <sub>r</sub>	Rise Time	V <sub>DS</sub> = 325V, I <sub>D</sub> = 4A, R <sub>G</sub> =25Ω		26		ns
t <sub>f</sub>	Fall Time	V <sub>DS</sub> = 325V, I <sub>D</sub> = 4A, R <sub>G</sub> =25Ω		25		ns
t <sub>d(on)</sub>	Turn-On Delay Time	V <sub>DS</sub> = 325V, I <sub>D</sub> = 4A, R <sub>G</sub> =25Ω		14		ns
t <sub>d(off)</sub>	Turn-Off Delay Time	V <sub>DS</sub> = 325V, I <sub>D</sub> = 4A, R <sub>G</sub> =25Ω		32		ns
<b>Control Section</b>						
f <sub>s</sub>	Switching Frequency	V <sub>CC</sub> = 14V, V <sub>FB</sub> = 4V	60	66	72	kHz
Δf <sub>s</sub>	Switching Frequency Variation <sup>(13)</sup>	-25°C < T <sub>J</sub> < 125°C		±5	±10	%
D <sub>MAX</sub>	Maximum Duty Ratio	V <sub>CC</sub> = 14V, V <sub>FB</sub> = 4V	65	70	75	%
D <sub>MIN</sub>	Minimum Duty Ratio	V <sub>CC</sub> = 14V, V <sub>FB</sub> = 0V			0	%
I <sub>FB</sub>	Feedback Source Current	V <sub>FB</sub> = 0	160	210	260	μA
V <sub>START</sub>	UVLO Threshold Voltage	V <sub>FB</sub> = 0V, V <sub>CC</sub> Sweep	11	12	13	V
V <sub>STOP</sub>		After Turn-on, V <sub>FB</sub> = 0V	7.0	7.5	8.0	V
V <sub>OP</sub>	V <sub>CC</sub> Operating Range		13		23	V
t <sub>S/S</sub>	Internal Soft-Start Time	V <sub>STR</sub> = 40V, V <sub>CC</sub> Sweep		15		ms
<b>Burst-Mode Section</b>						
V <sub>BURH</sub>	Burst-Mode Voltage	V <sub>CC</sub> = 14V, V <sub>FB</sub> Sweep	0.5	0.6	0.7	V
V <sub>BURL</sub>			0.3	0.4	0.5	V
Hys				200		mV
<b>Protection Section</b>						
I <sub>LIM</sub>	Peak Drain Current Limit	di/dt = 300mA/μs	2.75	3.00	3.25	A
V <sub>SD</sub>	Shutdown Feedback Voltage	V <sub>CC</sub> = 14V, V <sub>FB</sub> Sweep	5.5	6.0	6.5	V
I <sub>DELAY</sub>	Shutdown Delay Current	V <sub>CC</sub> = 14V, V <sub>FB</sub> = 4V	2.5	3.3	4.1	μA
t <sub>LEB</sub>	Leading-Edge Blanking Time <sup>(13)(14)</sup>			300		ns
V <sub>OVP</sub>	Over-Voltage Protection	V <sub>CC</sub> Sweep	23.0	24.5	26.0	V
t <sub>OSP</sub>	Output Short Protection <sup>(13)</sup>	Threshold Time	1.0	1.2	1.4	μs
V <sub>OSP</sub>		Threshold V <sub>FB</sub>	1.8	2.0	2.2	V
t <sub>OSP_FB</sub>		V <sub>FB</sub> Blanking Time	2.0	2.5	3.0	μs
T <sub>SD</sub>	Thermal Shutdown Temperature <sup>(13)</sup>	Shutdown Temperature	130	140	150	°C
Hys		Hysteresis		30		°C

Continued on the following page...

## Electrical Characteristics (Continued)

T<sub>J</sub> = 25°C unless otherwise specified.

Symbol	Parameter	Conditions	Min.	Typ.	Max.	Unit
<b>Total Device Section</b>						
I <sub>OP</sub>	Operating Supply Current, (Control Part in Burst Mode)	V <sub>CC</sub> = 14V, V <sub>FB</sub> = 0V	1.2	1.6	2.0	mA
I <sub>OPS</sub>	Operating Switching Current, (Control Part and SenseFET Part)	V <sub>CC</sub> = 14V, V <sub>FB</sub> = 4V	2.0	2.5	3.0	mA
I <sub>START</sub>	Start Current	V <sub>CC</sub> = 11V (Before V <sub>CC</sub> Reaches V <sub>START</sub> )	0.5	0.6	0.7	mA
I <sub>CH</sub>	Startup Charging Current	V <sub>CC</sub> = V <sub>FB</sub> = 0V, V <sub>STR</sub> = 40V	1.00	1.15	1.30	mA
V <sub>STR</sub>	Minimum V <sub>STR</sub> Supply Voltage	V <sub>CC</sub> = V <sub>FB</sub> = 0V, V <sub>STR</sub> Sweep		26		V

**Notes:**

13. Although these parameters are guaranteed, they are not 100% tested in production.
14. t<sub>LEB</sub> includes gate turn-on time.

## Comparison of FSDM0565RE and FSGM0565RB

Function	FSDM0565RE	FSGM0565RB	Advantages of FSGM0565RB
Burst Mode	Advanced Burst	Advanced Soft Burst	Low noise and low standby power
Lightning Surge		Strong	Enhanced SenseFET and controller against lightning surge
Soft-Start	10ms (Built-in)	15ms (Built-in)	Longer soft-start time
Protections	OLP OVP TSD	OLP OVP OSP AOC TSD with Hysteresis	Enhanced protections and high reliability
Power Balance	Long T <sub>CLD</sub>	Very Short T <sub>CLD</sub>	The difference of input power between the low and high input voltage is quite small

## Typical Performance Characteristics

Characteristic graphs are normalized at  $T_A=25^\circ\text{C}$ .

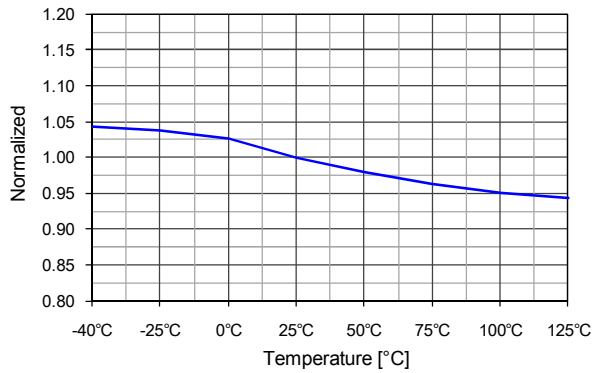

**Figure 5. Operating Supply Current ( $I_{OP}$ ) vs.  $T_A$**

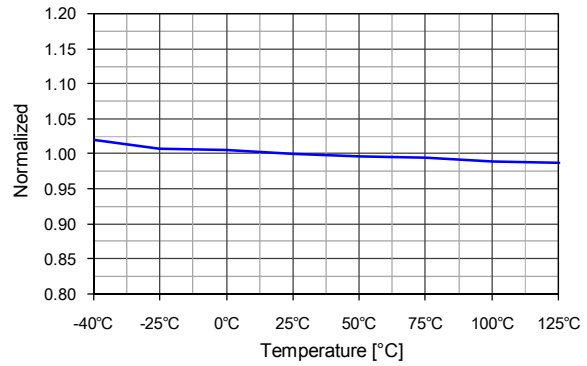

**Figure 6. Operating Switching Current ( $I_{OPS}$ ) vs.  $T_A$**

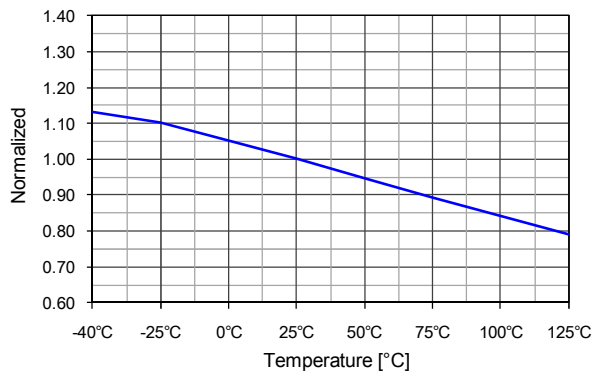

**Figure 7. Startup Charging Current ( $I_{CH}$ ) vs.  $T_A$**

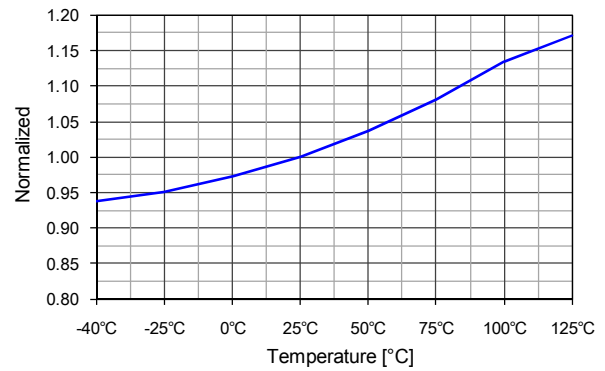

**Figure 8. Peak Drain Current Limit ( $I_{LIM}$ ) vs.  $T_A$**

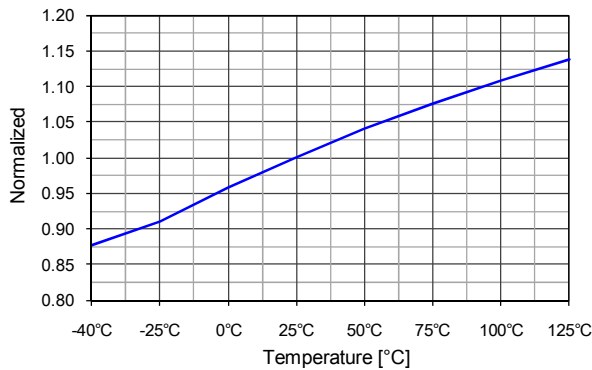

**Figure 9. Feedback Source Current ( $I_{FB}$ ) vs.  $T_A$**

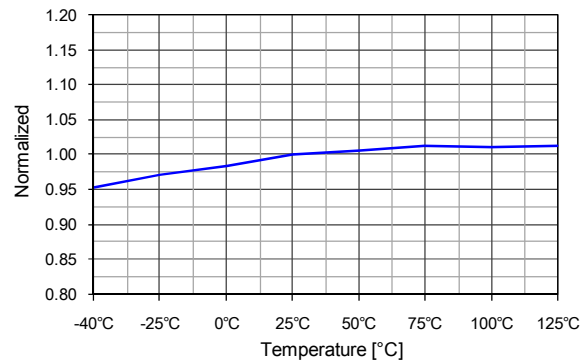

**Figure 10. Shutdown Delay Current ( $I_{DELAY}$ ) vs.  $T_A$**



## Typical Performance Characteristics

Characteristic graphs are normalized at  $T_A=25^\circ\text{C}$ .

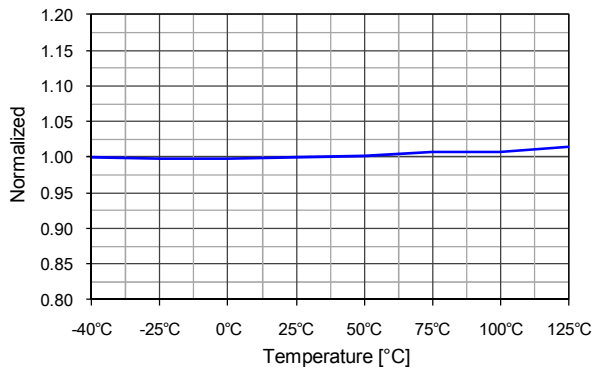

Figure 11. UVLO Threshold Voltage ( $V_{START}$ ) vs.  $T_A$

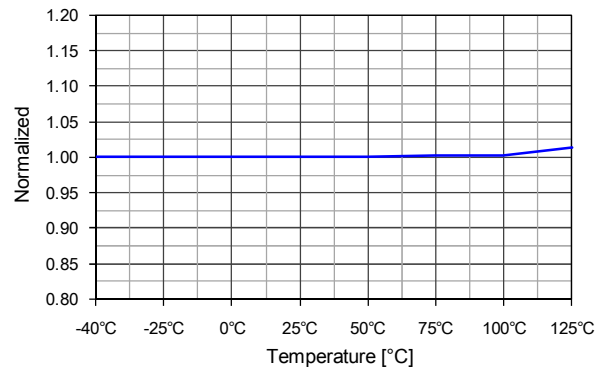

Figure 12. UVLO Threshold Voltage ( $V_{STOP}$ ) vs.  $T_A$

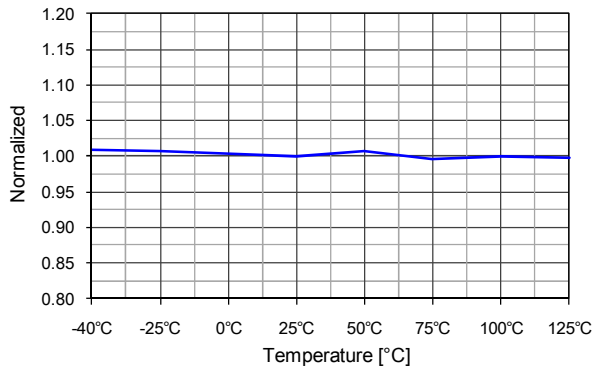

Figure 13. Shutdown Feedback Voltage ( $V_{SD}$ ) vs.  $T_A$

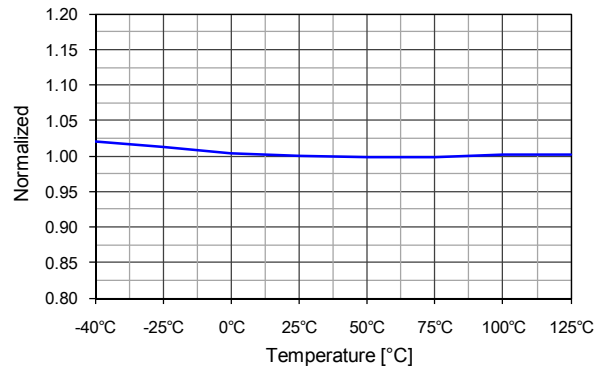

Figure 14. Over-Voltage Protection ( $V_{OVP}$ ) vs.  $T_A$

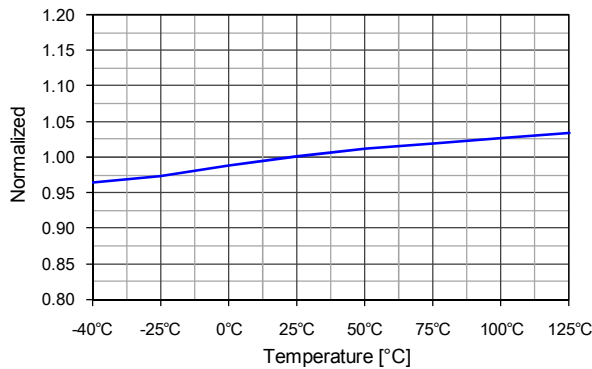

Figure 15. Switching Frequency ( $f_s$ ) vs.  $T_A$

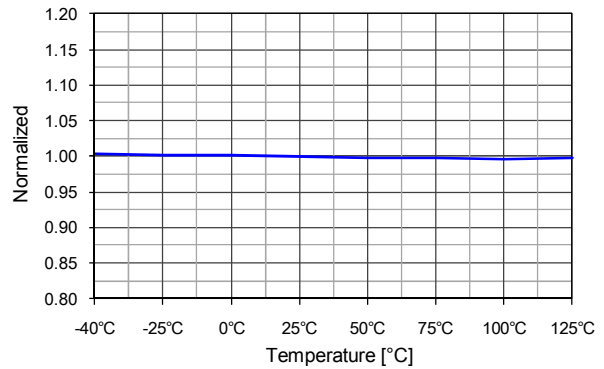
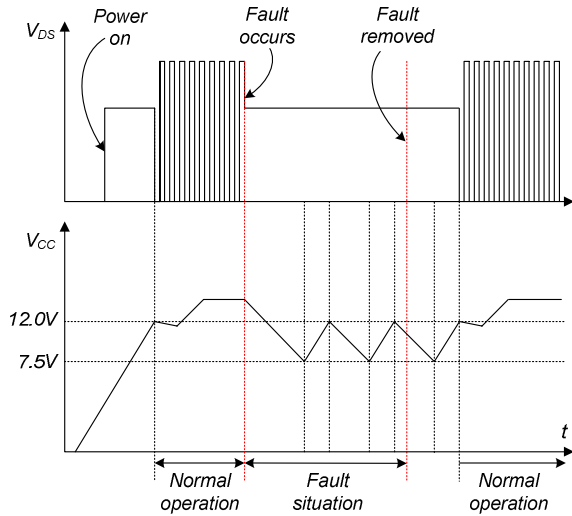

Figure 16. Maximim Duty Ratio ( $D_{MAX}$ ) vs.  $T_A$



**4. Protection Circuits:** The FSGM0565RB has several self-protective functions, such as Overload Protection (OLP), Abnormal Over-Current Protection (AOCP), Output-Short Protection (OSP), Over-Voltage Protection (OVP), and Thermal Shutdown (TSD). All the protections are implemented as auto-restart. Once the fault condition is detected, switching is terminated and the SenseFET remains off. This causes  $V_{CC}$  to fall. When  $V_{CC}$  falls to the Under-Voltage Lockout (UVLO) stop voltage of 7.5V, the protection is reset and the startup circuit charges the  $V_{CC}$  capacitor. When  $V_{CC}$  reaches the start voltage of 12.0V, the FSGM0565RB resumes normal operation. If the fault condition is not removed, the SenseFET remains off and  $V_{CC}$  drops to stop voltage again. In this manner, the auto-restart can alternately enable and disable the switching of the power SenseFET until the fault condition is eliminated. Because these protection circuits are fully integrated into the IC without external components, the reliability is improved without increasing cost.



**Figure 19. Auto-Restart Protection Waveforms**

**4.1 Overload Protection (OLP):** Overload is defined as the load current exceeding its normal level due to an unexpected abnormal event. In this situation, the protection circuit should trigger to protect the SMPS. However, even when the SMPS is in normal operation, the overload protection circuit can be triggered during the load transition. To avoid this undesired operation, the overload protection circuit is designed to trigger only after a specified time to determine whether it is a transient situation or a true overload situation. Because of the pulse-by-pulse current limit capability, the maximum peak current through the SenseFET is limited and, therefore, the maximum input power is restricted with a given input voltage. If the output consumes more than this maximum power, the output voltage ( $V_{OUT}$ ) decreases below the set voltage. This reduces the current through the opto-coupler LED, which also reduces the opto-coupler transistor current, thus increasing the feedback voltage ( $V_{FB}$ ). If  $V_{FB}$  exceeds 2.4V, D1 is blocked and the 3.3 $\mu$ A current source starts to charge  $C_{FB}$  slowly up. In this condition,  $V_{FB}$  continues

increasing until it reaches 6.0V, when the switching operation is terminated, as shown in Figure 20. The delay time for shutdown is the time required to charge  $C_{FB}$  from 2.4V to 6.0V with 3.3 $\mu$ A. A 25 ~ 50ms delay is typical for most applications. This protection is implemented in auto-restart mode.

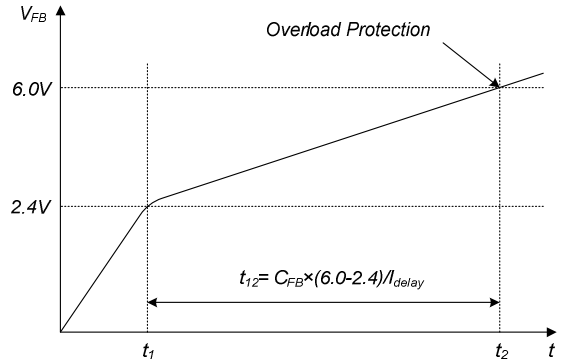

**Figure 20. Overload Protection**

**4.2 Abnormal Over-Current Protection (AOCP):** When the secondary rectifier diodes or the transformer pins are shorted, a steep current with extremely high di/dt can flow through the SenseFET during the minimum turn-on time. Even though the FSGM0565RB has overload protection, it is not enough to protect the FSGM0565RB in that abnormal case; since severe current stress is imposed on the SenseFET until OLP is triggered. The FSGM0565RB internal AOCP circuit is shown in Figure 21. When the gate turn-on signal is applied to the power SenseFET, the AOCP block is enabled and monitors the current through the sensing resistor. The voltage across the resistor is compared with a preset AOCP level. If the sensing resistor voltage is greater than the AOCP level, the set signal is applied to the S-R latch, resulting in the shutdown of the SMPS.

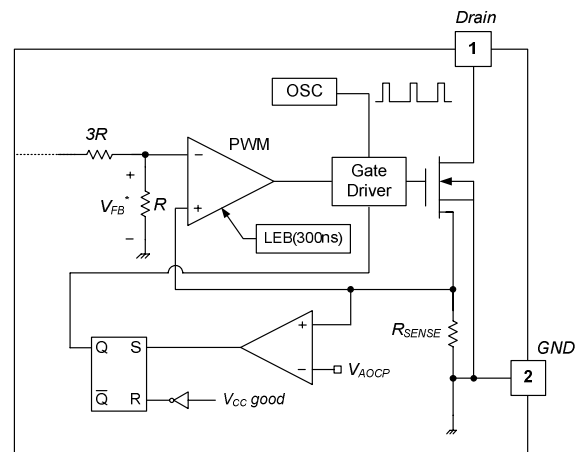

**Figure 21. Abnormal Over-Current Protection**

**4.3. Output-Short Protection (OSP):** If the output is shorted, steep current with extremely high di/dt can flow through the SenseFET during the minimum turn-on time. Such a steep current brings high-voltage stress on the drain of the SenseFET when turned off. To protect the device from this abnormal condition, OSP is included. It is comprised of detecting  $V_{FB}$  and SenseFET turn-on time. When the  $V_{FB}$  is higher than 2V and the SenseFET turn-on time is lower than  $1.2\mu s$ , the FSGM0565RB recognizes this condition as an abnormal error and shuts down PWM switching until  $V_{CC}$  reaches  $V_{START}$  again. An abnormal condition output short is shown in Figure 22.

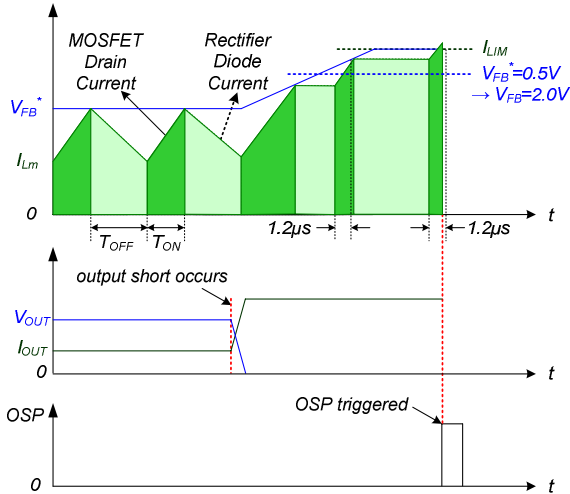
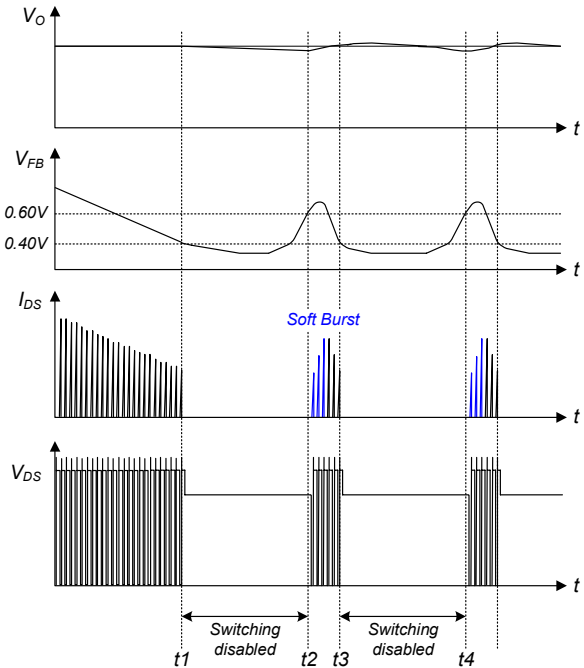

**Figure 22. Output-Short Protection**

**4.4 Over-Voltage Protection (OVP):** If the secondary-side feedback circuit malfunctions or a solder defect causes an opening in the feedback path, the current through the opto-coupler transistor becomes almost zero. Then  $V_{FB}$  climbs up in a similar manner to the overload situation, forcing the preset maximum current to be supplied to the SMPS until the overload protection is triggered. Because more energy than required is provided to the output, the output voltage may exceed the rated voltage before the overload protection is triggered, resulting in the breakdown of the devices in the secondary side. To prevent this situation, an OVP circuit is employed. In general, the  $V_{CC}$  is proportional to the output voltage and the FSGM0565RB uses  $V_{CC}$  instead of directly monitoring the output voltage. If  $V_{CC}$  exceeds 24.5V, an OVP circuit is triggered, resulting in the termination of the switching operation. To avoid undesired activation of OVP during normal operation,  $V_{CC}$  should be designed to be below 24.5V.

**4.5 Thermal Shutdown (TSD):** The SenseFET and the control IC on a die in one package makes it easier for the control IC to detect the over temperature of the SenseFET. If the temperature exceeds  $\sim 140^{\circ}C$ , the thermal shutdown is triggered and the FSGM0565RB stops operation. The FSGM0565RB operates in auto-restart mode until the temperature decreases to around  $110^{\circ}C$ , when normal operation resumes.

**5. Soft Burst-Mode Operation:** To minimize power dissipation in standby mode, the FSGM0565RB enters burst-mode operation. As the load decreases, the feedback voltage decreases. As shown in Figure 23, the device automatically enters burst mode when the feedback voltage drops below  $V_{BURL}$  (400mV). At this point, switching stops and the output voltages start to drop at a rate dependent on standby current load. This causes the feedback voltage to rise. Once it passes  $V_{BURH}$  (600mV), switching resumes. At this point, the drain current peak increases gradually. This soft burst-mode can reduce audible noise during burst-mode operation. The feedback voltage then falls and the process repeats. Burst-mode operation alternately enables and disables switching of the SenseFET, thereby reducing switching loss in standby mode.



**Figure 23. Burst-Mode Operation**

## Typical Application Circuit

Application	Input Voltage	Rated Output	Rated Power
LCD TV, Monitor Power Supply	390V <sub>DC</sub>	5.0V(4A) 12.0V(4A)	68W

### Key Design Notes:

- The delay time for overload protection is designed to be about 25ms with C105 (22nF). OLP time between 25ms (22nF) and 50ms (43nF) is recommended.
- The SMD-type capacitor (C106) must be placed as close as possible to the V<sub>CC</sub> pin to avoid malfunction by abrupt pulsating noises and to improve ESD and surge immunity. Capacitance between 100nF and 220nF is recommended.

### 1. Schematic

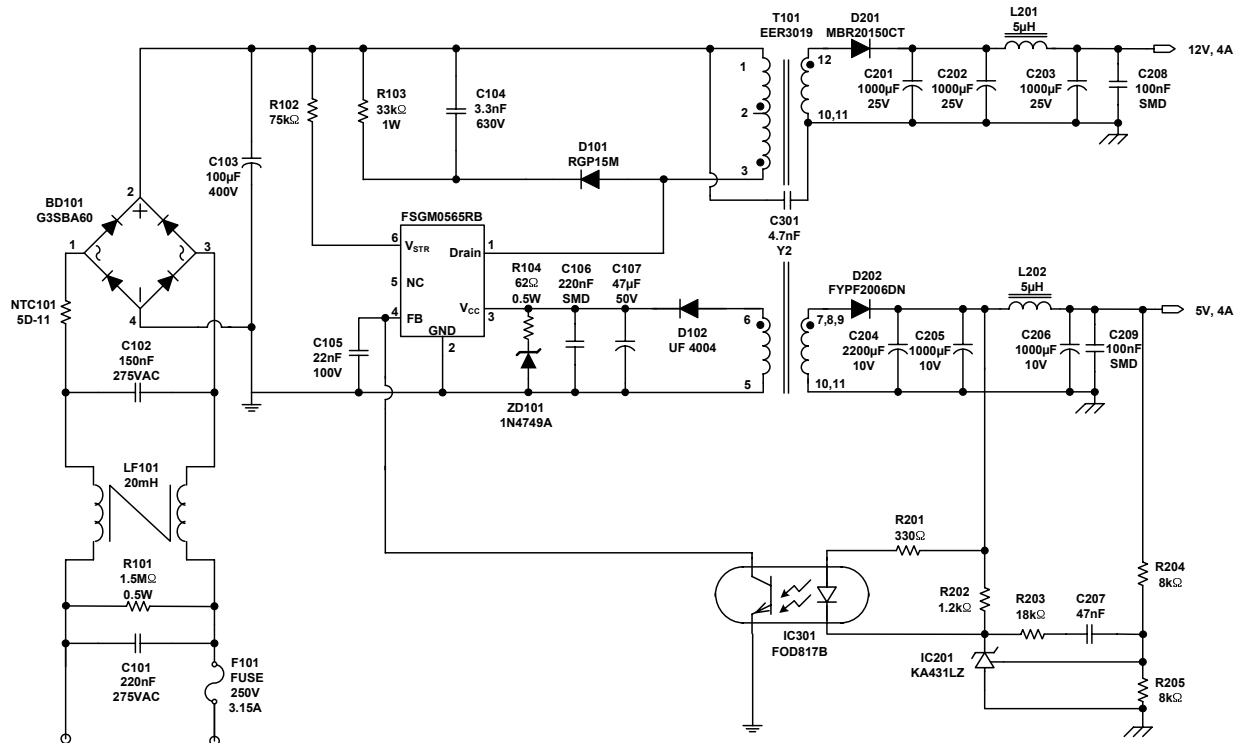

Figure 24. Schematic of Demonstration Board

## 2. Transformer

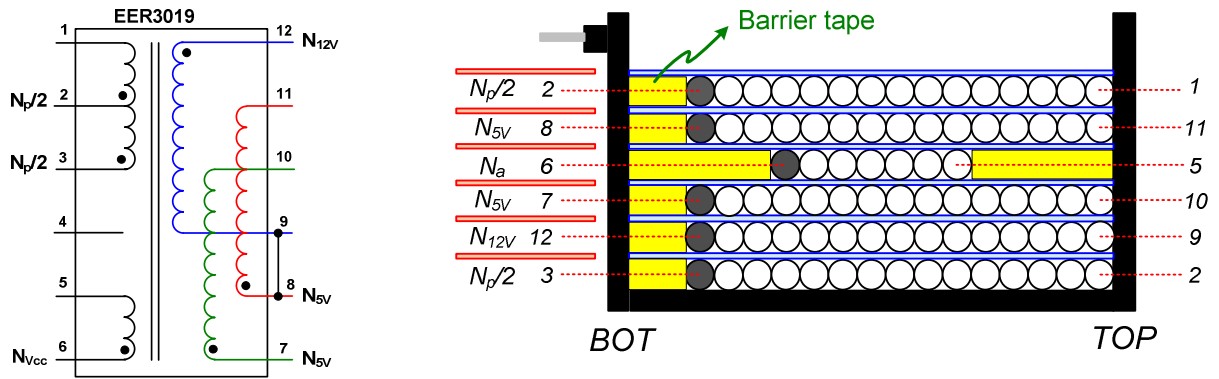

Figure 25. Schematic of Transformer

## 3. Winding Specification

	Pin (S → F)	Wire	Turns	Winding Method	Barrier Tape		
					TOP	BOT	Ts
$N_p/2$	3 → 2	0.33φ×1	22	Solenoid Winding		2.0mm	1
Insulation: Polyester Tape t = 0.025mm, 2 Layers							
$N_{12V}$	12 → 9	0.4φ×3 (TIW)	4	Solenoid Winding		2.0mm	1
Insulation: Polyester Tape t = 0.025mm, 2 Layers							
$N_{5V}$	7 → 10	0.4φ×4 (TIW)	3	Solenoid Winding		2.0mm	1
Insulation : Polyester Tape t = 0.025mm, 2 Layers							
$N_a$	6 → 5	0.2φ×1	7	Solenoid Winding	4.0mm	4.0mm	1
Insulation: Polyester Tape t = 0.025mm, 2 Layers							
$N_{5V}$	8 → 11	0.4φ×4 (TIW)	3	Solenoid Winding		2.0mm	1
Insulation: Polyester Tape t = 0.025mm, 2 Layers							
$N_p/2$	2 → 1	0.33φ×1	21	Solenoid Winding		2.0mm	1
Insulation: Polyester Tape t = 0.025mm, 2 Layers							

## 4. Electrical Characteristics

	Pin	Specification	Remark
Inductance	1 – 3	600μH ± 7%	67kHz, 1V
Leakage	1 – 3	15μH Maximum	Short All Other Pins

## 5. Core & Bobbin

- Core: EER3019 ( $A_e=134.0\text{mm}^2$ )
- Bobbin: EER3019

## 6. Bill of Materials

Part #	Value	Note	Part #	Value	Note
<b>Fuse</b>			<b>Capacitor</b>		
F101	250V 3.15A		C101	220nF/275V	Box (Pilkor)
<b>NTC</b>			C102	150nF/275V	Box (Pilkor)
NTC101	5D-11	DSC	C103	100μF/400V	Electrolytic (SamYoung)
<b>Resistor</b>			C104	3.3nF/630V	Film (Sehwa)
R101	1.5MΩ, J	0.5W	C105	22nF/100V	Film (Sehwa)
R102	75kΩ, J	1/2W	C106	220nF	SMD (2012)
R103	33kΩ, J	1W	C107	47μF/50V	Electrolytic (SamYoung)
R104	62Ω, J	1/2W	C201	1000μF/25V	Electrolytic (SamYoung)
R201	330Ω, J	1/4W	C202	1000μF/25V	Electrolytic (SamYoung)
R202	1.2kΩ, F	1/4W, 1%	C203	1000μF/25V	Electrolytic (SamYoung)
R203	18kΩ, F	1/4W, 1%	C204	2200μF/10V	Electrolytic (SamYoung)
R204	8kΩ, F	1/4W, 1%	C205	1000μF/16V	Electrolytic (SamYoung)
R205	8kΩ, F	1/4W, 1%	C206	1000μF/16V	Electrolytic (SamYoung)
<b>IC</b>			C207	47nF/100V	Film (Sehwa)
FSGM0565RB	FSGM0565RB	Fairchild Semiconductor	C208	100nF	SMD (2012)
IC201	KA431LZ	Fairchild Semiconductor	C209	100nF	SMD (2012)
IC301	FOD817B	Fairchild Semiconductor	C301	4.7nF/Y2	Y-cap (Samhwa)
<b>Diode</b>			<b>Inductor</b>		
D101	RGP15M	Vishay	LF101	20mH	Line filter 0.7Ø
D102	UF4004	Vishay	L201	5μH	5A Rating
ZD101	1N4749	Vishay	L202	5μH	5A Rating
D201	MBR20150CT	Fairchild Semiconductor	<b>Jumper</b>		
D202	FYPF2006DN	Fairchild Semiconductor	J101		
BD101	G3SBA60	Vishay	<b>Transformer</b>		
			T101	600μH	

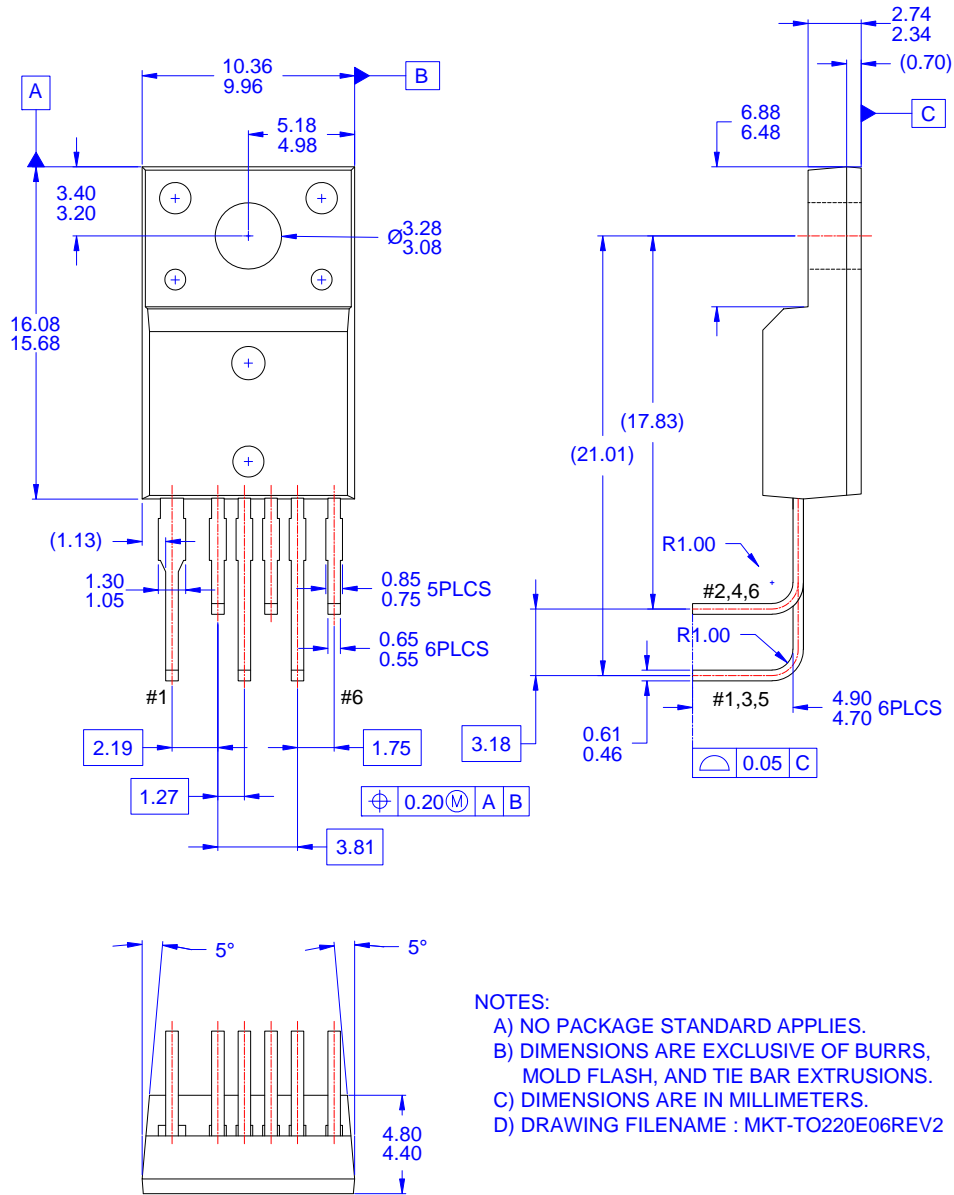

- NOTES:
- A) NO PACKAGE STANDARD APPLIES.
  - B) DIMENSIONS ARE EXCLUSIVE OF BURRS, MOLD FLASH, AND TIE BAR EXTRUSIONS.
  - C) DIMENSIONS ARE IN MILLIMETERS.
  - D) DRAWING FILENAME : MKT-TO220E06REV2

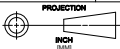
APPROVALS		DATE				
DRAWN: J.U. COMPARATIVO JR.		03MAR2010			<b>6LD, TO220, FULLPACK L-FORMING</b>	
CHECKED: L. STA CRUZ						
APPROVED: M.R. GESTOLE						
C.N. TANGPUZ			SCALE: 1:1	SIZE: NA	DRAWING NUMBER: MKT-TO220E06	REV: 2
			FORMERLY: N/A	SHEET: 1 OF 1		



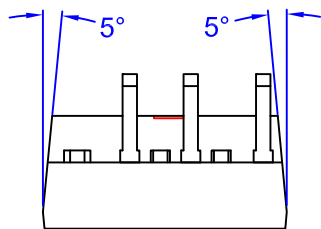
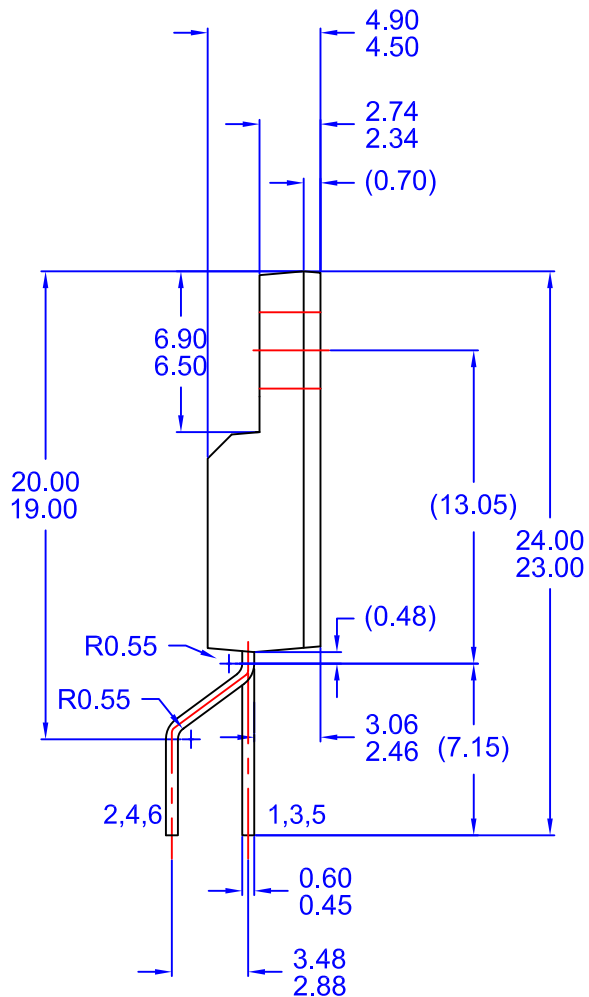
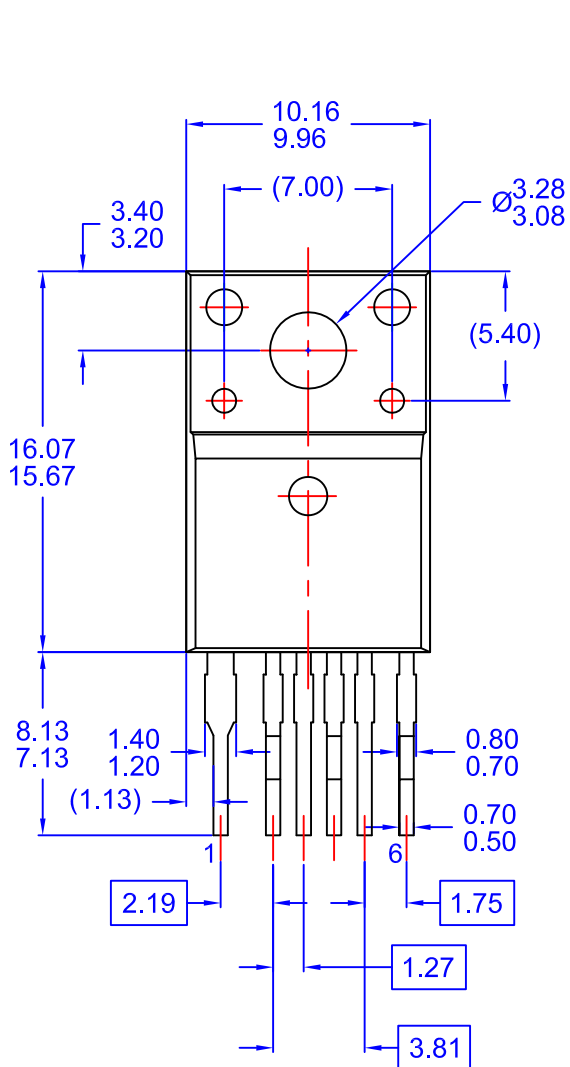

- NOTES: UNLESS OTHERWISE SPECIFIED  
 A) THIS PACKAGE DOES NOT COMPLY TO ANY CURRENT PACKAGING STANDARD.  
 B) ALL DIMENSIONS ARE IN MILLIMETERS.  
 C) DIMENSIONS ARE EXCLUSIVE OF BURRS, MOLD FLASH, AND TIE BAR EXTRUSIONS.  
 D) LEADFORM OPTION A  
 E) DRAWING FILENAME: TO220A06REV5



ON Semiconductor and  are trademarks of Semiconductor Components Industries, LLC dba ON Semiconductor or its subsidiaries in the United States and/or other countries. ON Semiconductor owns the rights to a number of patents, trademarks, copyrights, trade secrets, and other intellectual property. A listing of ON Semiconductor's product/patent coverage may be accessed at [www.onsemi.com/site/pdf/Patent-Marking.pdf](http://www.onsemi.com/site/pdf/Patent-Marking.pdf). ON Semiconductor reserves the right to make changes without further notice to any products herein. ON Semiconductor makes no warranty, representation or guarantee regarding the suitability of its products for any particular purpose, nor does ON Semiconductor assume any liability arising out of the application or use of any product or circuit, and specifically disclaims any and all liability, including without limitation special, consequential or incidental damages. Buyer is responsible for its products and applications using ON Semiconductor products, including compliance with all laws, regulations and safety requirements or standards, regardless of any support or applications information provided by ON Semiconductor. "Typical" parameters which may be provided in ON Semiconductor data sheets and/or specifications can and do vary in different applications and actual performance may vary over time. All operating parameters, including "Typicals" must be validated for each customer application by customer's technical experts. ON Semiconductor does not convey any license under its patent rights nor the rights of others. ON Semiconductor products are not designed, intended, or authorized for use as a critical component in life support systems or any FDA Class 3 medical devices or medical devices with a same or similar classification in a foreign jurisdiction or any devices intended for implantation in the human body. Should Buyer purchase or use ON Semiconductor products for any such unintended or unauthorized application, Buyer shall indemnify and hold ON Semiconductor and its officers, employees, subsidiaries, affiliates, and distributors harmless against all claims, costs, damages, and expenses, and reasonable attorney fees arising out of, directly or indirectly, any claim of personal injury or death associated with such unintended or unauthorized use, even if such claim alleges that ON Semiconductor was negligent regarding the design or manufacture of the part. ON Semiconductor is an Equal Opportunity/Affirmative Action Employer. This literature is subject to all applicable copyright laws and is not for resale in any manner.

## PUBLICATION ORDERING INFORMATION

### LITERATURE FULFILLMENT:

Literature Distribution Center for ON Semiconductor  
19521 E. 32nd Pkwy, Aurora, Colorado 80011 USA  
**Phone:** 303-675-2175 or 800-344-3860 Toll Free USA/Canada  
**Fax:** 303-675-2176 or 800-344-3867 Toll Free USA/Canada  
**Email:** [orderlit@onsemi.com](mailto:orderlit@onsemi.com)

**N. American Technical Support:** 800-282-9855 Toll Free  
USA/Canada  
**Europe, Middle East and Africa Technical Support:**  
Phone: 421 33 790 2910  
**Japan Customer Focus Center**  
Phone: 81-3-5817-1050

**ON Semiconductor Website:** [www.onsemi.com](http://www.onsemi.com)  
**Order Literature:** <http://www.onsemi.com/orderlit>  
For additional information, please contact your local  
Sales Representative

# Mouser Electronics

Authorized Distributor

Click to View Pricing, Inventory, Delivery & Lifecycle Information:

[ON Semiconductor:](#)

[FSGM0565RBLDTU](#) [FSGM0565RBWDTU](#) [FSGM0565RBUDTU](#)

Компания «Life Electronics» занимается поставками электронных компонентов импортного и отечественного производства от производителей и со складов крупных дистрибьюторов Европы, Америки и Азии.

С конца 2013 года компания активно расширяет линейку поставок компонентов по направлению коаксиальный кабель, кварцевые генераторы и конденсаторы (керамические, пленочные, электролитические), за счёт заключения дистрибьюторских договоров

Мы предлагаем:

- Конкурентоспособные цены и скидки постоянным клиентам.
- Специальные условия для постоянных клиентов.
- Подбор аналогов.
- Поставку компонентов в любых объемах, удовлетворяющих вашим потребностям.
- Приемлемые сроки поставки, возможна ускоренная поставка.
- Доставку товара в любую точку России и стран СНГ.
- Комплексную поставку.
- Работу по проектам и поставку образцов.
- Формирование склада под заказчика.
- Сертификаты соответствия на поставляемую продукцию (по желанию клиента).
- Тестирование поставляемой продукции.
- Поставку компонентов, требующих военную и космическую приемку.
- Входной контроль качества.
- Наличие сертификата ISO.

В составе нашей компании организован Конструкторский отдел, призванный помогать разработчикам, и инженерам.

Конструкторский отдел помогает осуществить:

- Регистрацию проекта у производителя компонентов.
- Техническую поддержку проекта.
- Защиту от снятия компонента с производства.
- Оценку стоимости проекта по компонентам.
- Изготовление тестовой платы монтаж и пусконаладочные работы.



Тел: +7 (812) 336 43 04 (многоканальный)

Email: [org@lifeelectronics.ru](mailto:org@lifeelectronics.ru)