

**SINGLE-PHASE GLASS PASSIVATED  
SILICON BRIDGE RECTIFIER**  
VOLTAGE RANGE 100 to 1000 Volts CURRENT 0.8 Ampere

**FEATURES**

- \* Surge overload rating - 30 amperes peak
- \* Ideal for printed circuit board
- \* Reliable low cost construction utilizing molded
- \* Glass passivated device
- \* Polarity symbols molded on body
- \* Mounting position: Any
- \* P/N suffix V means AEC-Q101 qualified, e.g:MB1FV
- \* P/N suffix V means Halogen-free

**MECHANICAL DATA**

- \* Epoxy: Device has UL flammability classification 94V-O

**MAXIMUM RATINGS AND ELECTRICAL CHARACTERISTICS**

Ratings at 25 °C ambient temperature unless otherwise specified.  
resistive or inductive load.

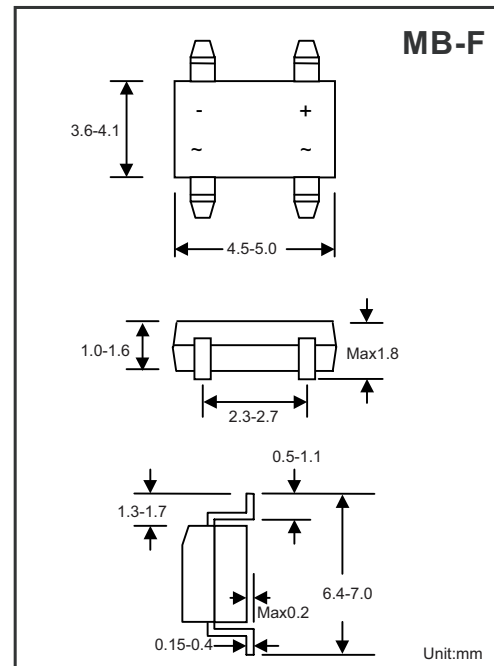

MAXIMUM RATINGS (At  $T_A = 25^\circ\text{C}$  unless otherwise noted)

RATINGS		SYMBOL	MB1F	MB2F	MB4F	MB6F	MB8F	MB10F	UNITS
Maximum Recurrent Peak Reverse Voltage		$V_{RRM}$	100	200	400	600	800	1000	Volts
Maximum RMS Bridge Input Voltage		$V_{RMS}$	70	140	280	420	560	700	Volts
Maximum DC Blocking Voltage		$V_{DC}$	100	200	400	600	800	1000	Volts
Maximum Average Forward Rectified Current	$T_A = 125^\circ\text{C}$	$I_o$	0.5						Amps
	$T_A = 110^\circ\text{C}$		0.8						
Peak Forward Surge Current 8.3 ms single half sine-wave superimposed on rated load (JEDEC method)		$I_{FSM}$	30						Amps
Peak Forward Surge Current 10 ms single half sine-wave superimposed on rated load (JEDEC method)		$I_{FSM}$	27.3						Amps
Typical Current Squared Time		$I^2t$	3.74						$\text{A}^2\text{S}$
Typical Thermal Resistance(Note2)		$R_{\theta JA}$	64						$^\circ\text{C}/\text{W}$
		$R_{\theta JL}$	39						
Operating and Storage Temperature Range		$T_J, T_{STG}$	-55 to + 150						$^\circ\text{C}$

ELECTRICAL CHARACTERISTICS (At  $T_A = 25^\circ\text{C}$  unless otherwise noted)

CHARACTERISTICS		SYMBOL	MB1F	MB2F	MB4F	MB6F	MB8F	MB10F	UNITS
Maximum Forward Voltage Drop per Bridge Element at 0.8 A DC		$V_F$	1.1						Volts
Maximum Reverse Current at Rated DC Blocking Voltage per element	@ $T_A = 25^\circ\text{C}$	$I_R$	1.0						$\mu\text{Amps}$
	@ $T_A = 150^\circ\text{C}$		2						$\text{mAmps}$

NOTES:1. Typical Thermal Resistance : At 9.5mm lead lengths,PCB mounted.

2019-03/18  
REV:F

## RATING AND CHARACTERISTICS CURVES ( MB1F THRU MB10F )

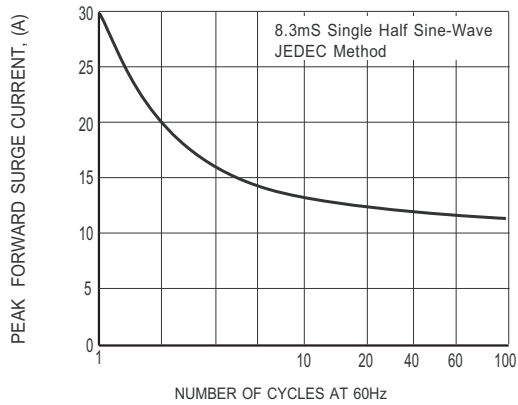

FIG. 1 MAXIMUM NON-REPETITIVE FORWARD SURGE CURRENT

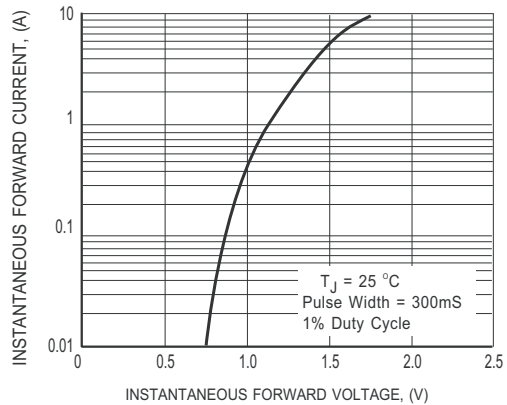

FIG. 2 MAXIMUM INSTANTANEOUS FORWARD CHARACTERISTICS

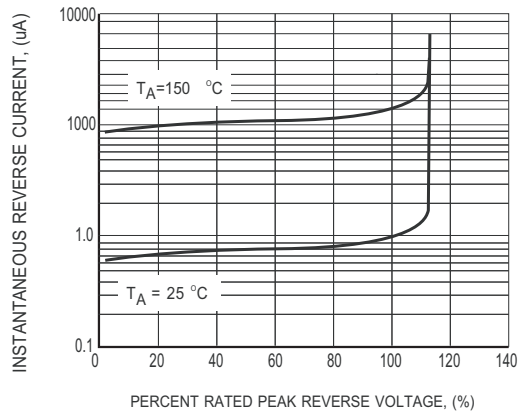

FIG. 3 MAXIMUM REVERSE CHARACTERISTICS

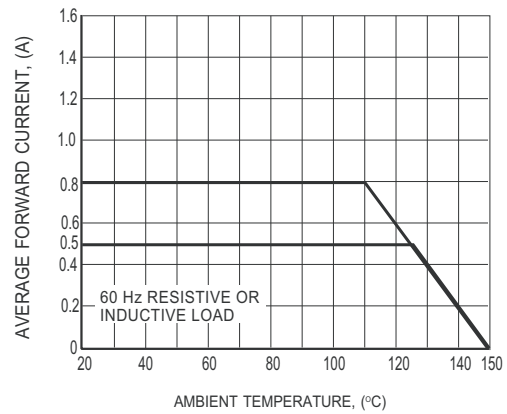
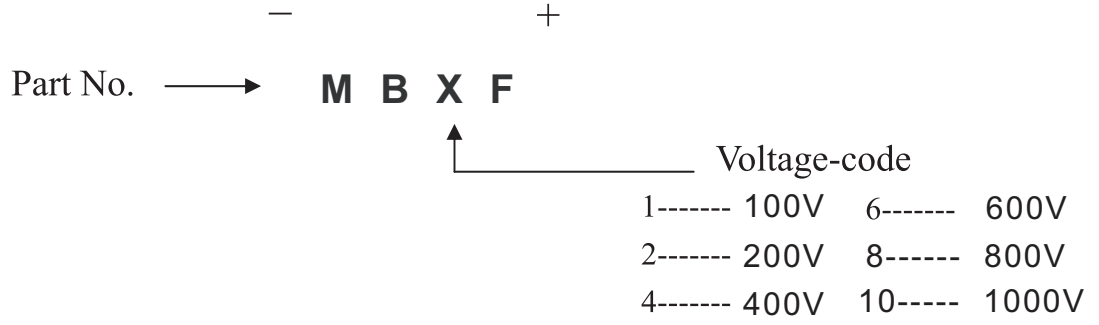
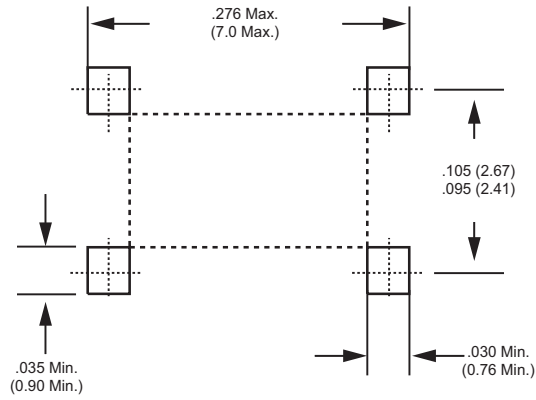

FIG. 4 TYPICAL FORWARD CURRENT DERATING CURVE

**Marking Description**



## Mounting Pad Layout



Dimensions in inches and (millimeters)

## PACKAGING OF DIODE AND BRIDGE RECTIFIERS

### REEL PACK

PACKAGE	PACKING CODE	EA PER REEL	EA PER INNER BOX	COMPONENT SPACE (mm)	TAPE SPACE (mm)	REEL DIA (mm)	CARTON SIZE (mm)	EA PER CARTON	GROSS WEIGHT(Kg)
MB-F	-W	5,000	10,000			330	360*335*360	80,000	25.83

## DISCLAIMER NOTICE

Rectron Inc reserves the right to make changes without notice to any product specification herein, to make corrections, modifications, enhancements or other changes. Rectron Inc or anyone on its behalf assumes no responsibility or liability for any errors or inaccuracies. Data sheet specifications and its information contained are intended to provide a product description only. "Typical" parameters which may be included on RECTRON data sheets and/ or specifications can and do vary in different applications and actual performance may vary over time. Rectron Inc does not assume any liability arising out of the application or use of any product or circuit.

Rectron products are not designed, intended or authorized for use in medical, life-saving implant or other applications intended for life-sustaining or other related applications where a failure or malfunction of component or circuitry may directly or indirectly cause injury or threaten a life without expressed written approval of Rectron Inc. Customers using or selling Rectron components for use in such applications do so at their own risk and shall agree to fully indemnify Rectron Inc and its subsidiaries harmless against all claims, damages and expenditures.

Компания «Life Electronics» занимается поставками электронных компонентов импортного и отечественного производства от производителей и со складов крупных дистрибьюторов Европы, Америки и Азии.

С конца 2013 года компания активно расширяет линейку поставок компонентов по направлению коаксиальный кабель, кварцевые генераторы и конденсаторы (керамические, пленочные, электролитические), за счёт заключения дистрибьюторских договоров

Мы предлагаем:

- Конкурентоспособные цены и скидки постоянным клиентам.
- Специальные условия для постоянных клиентов.
- Подбор аналогов.
- Поставку компонентов в любых объемах, удовлетворяющих вашим потребностям.
- Приемлемые сроки поставки, возможна ускоренная поставка.
- Доставку товара в любую точку России и стран СНГ.
- Комплексную поставку.
- Работу по проектам и поставку образцов.
- Формирование склада под заказчика.
- Сертификаты соответствия на поставляемую продукцию (по желанию клиента).
- Тестирование поставляемой продукции.
- Поставку компонентов, требующих военную и космическую приемку.
- Входной контроль качества.
- Наличие сертификата ISO.

В составе нашей компании организован Конструкторский отдел, призванный помогать разработчикам, и инженерам.

Конструкторский отдел помогает осуществить:

- Регистрацию проекта у производителя компонентов.
- Техническую поддержку проекта.
- Защиту от снятия компонента с производства.
- Оценку стоимости проекта по компонентам.
- Изготовление тестовой платы монтаж и пусконаладочные работы.



Тел: +7 (812) 336 43 04 (многоканальный)

Email: [org@lifeelectronics.ru](mailto:org@lifeelectronics.ru)