

FEATURES

- Temperature measurements require no external components with $\pm 1^{\circ}\text{C}$ accuracy
- Measures temperatures from -55°C to $+125^{\circ}\text{C}$; Fahrenheit equivalent is -67°F to $+257^{\circ}\text{F}$
- Temperature resolution is configurable from 9 to 12 (default) bits (0.5°C to 0.0625°C resolution)
- Maximum conversion time (9-bit resolution) of 93.75 ms
- Thermostatic settings are user-definable
- Data is read/written via a 2-wire serial interface (open drain I/O lines); 3-bit addressability
- Wide power supply range (2.7V - 5.5V)
- Applications include personal computers, cellular telephones, office equipment, or any thermally sensitive system
- 8-pin, 150-mil SOIC package and 8-pin μSOP package

DESCRIPTION

The DS1721 2-Wire Digital Thermometer and Thermostat provides 12-bit temperature readings, which indicate the temperature of the device. Thermostatic settings and temperature readings are all communicated to/from the DS1721 over a simple 2-wire serial interface. No additional components are required; the device is truly a “temperature-to-digital” converter.

The DS1721 has three address bits that allow a user to multidrop up to eight sensors along the 2-wire bus, greatly simplifying the bussing of distributed temperature sensing networks.

The thermal alarm output, T_{OUT} , is active when the temperature of the device exceeds a user-defined temperature TH. The output remains active until the temperature is equal to or below the user-defined temperature TL, allowing for any hysteresis necessary. The active state of T_{OUT} is configurable by the user.

For applications that require faster conversion times, the user can adjust the readout resolution from 12 to 9 bits, effectively reducing the conversion time from 750ms (MAX) to 93.75 ms (MAX). This is particularly useful in applications where temperature changes large magnitudes very rapidly.

Applications for DS1721 include personal computers/services, cellular telephones, office equipment, or any microprocessor-based, thermally sensitive system.

PIN ASSIGNMENT

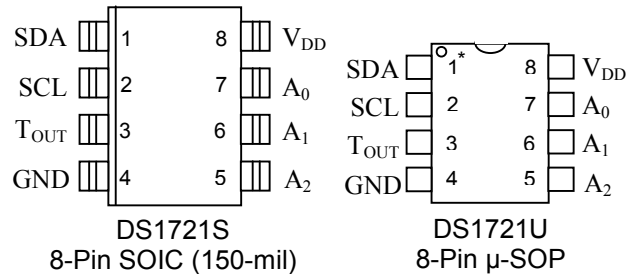

PIN DESCRIPTION

- | | |
|------------------|-----------------------------------|
| SDA | - 2-Wire Serial Data Input/Output |
| SCL | - 2-Wire Serial Clock |
| GND | - Ground |
| T_{OUT} | - Thermostat Output Signal |
| A_0 | - Chip Address Input |
| A_1 | - Chip Address Input |
| A_2 | - Chip Address Input |
| V_{DD} | - Power Supply Voltage (+5V) |

ORDERING INFORMATION

ORDERING INFORMATION	PACKAGE MARKING	DESCRIPTION
DS1721S	DS1721	DS1721 in 150 mil 8-pin SO
DS1721S+	DS1721 (See Note)	DS1721 in Lead-Free 150 mil 8-pin SO
DS1721S/T&R	DS1721	DS1721 in 150 mil 8-pin SO, 2500 Piece Tape-and-Reel
DS1721S+T&R	DS1721 (See Note)	DS1721 in Lead-Free 150 mil 8-pin SO, 2500 Piece Tape-and-Reel
DS1721U	1721	DS1721 in 8-pin uSOP
DS1721U+	1721 (See Note)	DS1721 in Lead-Free 8-pin uSOP
DS1721U/T&R	1721	DS1721 in 8-pin uSOP, 3000 Piece Tape-and-Reel
DS1721U+T&R	1721 (See Note)	DS1721 in Lead-Free 8-pin uSOP, 3000 Piece Tape-and-Reel

Note: A "+" symbol will also be marked on the package near the Pin 1 indicator.

DETAILED PIN DESCRIPTION Table 1

PIN	SYMBOL	DESCRIPTION
1	SDA	Data input/output pin. For 2-wire serial communication port.
2	SCL	Clock input/output pin. For 2-wire serial communication port.
3	T _{OUT}	Thermostat output. Active when temperature exceeds TH; will reset when temperature falls below TL.
4	GND	Ground pin.
5	A2	Address input pin.
6	A1	Address input pin.
7	A0	Address input pin.
8	V _{DD}	Supply Voltage. 2.7V to 5.5V input power pin.

OVERVIEW

A block diagram of the DS1721 is shown in Figure 1.

The DS1721 consists of five major components:

1. Precision temperature sensor
2. Analog-to-digital converter
3. 2-wire interface electronics
4. Data registers
5. Thermostat comparator

The factory-calibrated temperature sensor requires no external components. Upon power-up, the DS1721 is in an idle mode. Upon issuance of a Start Convert T command [51h], the DS1721 begins temperature conversions with the default resolution of 12 bits (0.0625°C resolution). Following an 8-bit command protocol, temperature data can be read over the 2-wire interface. The host can periodically read the value in the temperature register, which contains the last completed conversion. As conversions are performed in the background, reading the temperature register does not affect the conversion in progress.

In power-sensitive applications, the user can put the DS1721 in a “one-shot” mode, under which the sensor will complete and store one temperature conversion and return to a low-power standby state. In time-sensitive applications, the user can change the conversion resolution from 12 bits to 9, 10, or 11.

Each additional bit of resolution approximately doubles the conversion time, so 9-bit conversions can be performed in less than a quarter of a second.

This is accomplished by issuing a command protocol to the configuration register. It is recommended that the user issue the command protocol to program the configuration register before any temperature conversion commands are issued after power-up. This is due to the fact that the configuration data is stored in volatile memory and will always power-up in the default state. The configuration register defines the conversion mode, thermometer resolution/conversion time, and active state of the thermostat comparator output. It also contains 3 status bits denoting the state of temperature conversions and thermostat flags.

The user can also program over-temperature (TH) and under-temperature (TL) setpoints for thermostatic operation. The power-up state of TH is 80°C and that for TL is 75°C. The result of each temperature conversion is compared with these setpoints. The thermostat output (T_{OUT}) becomes active when the measured temperature exceeds the programmed TH, and remains latched in the active state until temperature falls below TL. Thus, any hysteresis can be realized for fan control without external components.

Digital data is written to/read from the DS1721 via a 2-wire interface, and all communication is MSb first. Multipoint sensing is possible with the DS1721 by uniquely setting the 3-bit address of up to eight parts on the 2-wire bus.

DS1721 FUNCTIONAL BLOCK DIAGRAM Figure 1

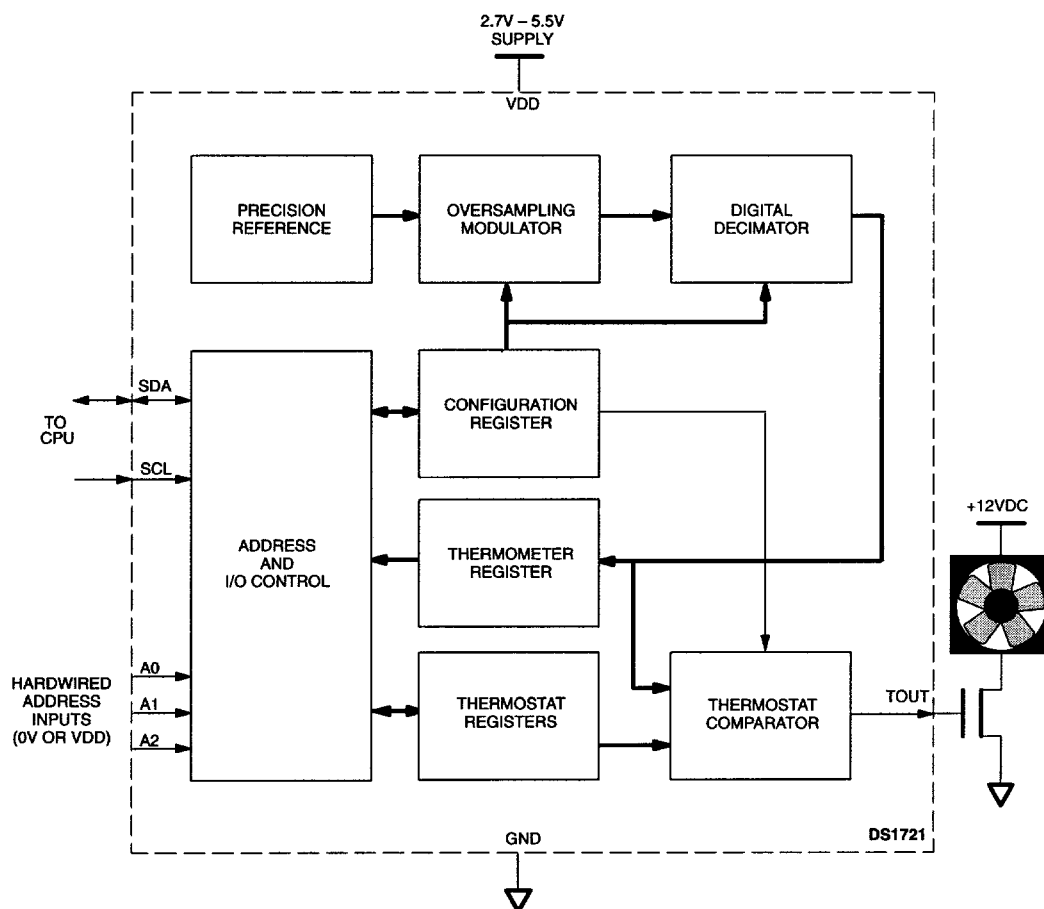

OPERATION-Measuring Temperature

The core of DS1721 functionality is its direct-to-digital temperature sensor. The DS1721 measures temperature through the use of an on-chip temperature measurement technique with an operation range from -55°C to $+125^{\circ}\text{C}$. The device can be configured to perform continuous conversions with the most recent result being stored in the thermometer register. The device can also be configured to perform a single conversion, store the result, and return to a standby mode. Regardless of the mode used, the digital temperature is retrieved from the temperature register using the Read Temperature (AAh) command, as described in detail in the “Command Set” section. The DS1721 power-up default has the sensor set to automatically perform 12-bit conversions continuously once the Start Convert T (51h) command is issued. Details on how to change the settings after power-up are contained in the “OPERATION-Programming” section.

The resolution of the temperature conversion can be configured as 9, 10, 11, or 12 bits, with 12-bit readings as the default state. This equates to a temperature resolution of 0.5°C , 0.25°C , 0.125°C , or 0.0625°C . Following each conversion thermal data is stored in the thermometer register in two's complement format; the information can be retrieved over the 2-wire interface by issuing a Read Temperature (AAh) command. Table 2 describes the exact relationship of output data to measured temperature. The table assumes the DS1721 is configured for 12-bit resolution; if the device is configured in a lower resolution mode, insignificant bits will contain zeros. The data is transmitted serially over the 2-wire serial interface, MSb first. The MSb of the temperature register contains the “sign” (S) bit, denoting whether the temperature is positive or negative. For Fahrenheit usage, a lookup table or conversion routine must be used.

TEMPERATURE/DATA RELATIONSHIPS Table 2

S	2^6	2^5	2^4	2^3	2^2	2^1	2^0	MSB
MSb	(UNIT = $^{\circ}\text{C}$)						LSb	
2^{-1}	2^{-2}	2^{-3}	2^{-4}	0	0	0	0	LSB

TEMP	DIGITAL OUTPUT (Binary)	DIGITAL OUTPUT (Hex)
$+125^{\circ}\text{C}$	0111 1101 0000 0000	7D00h
$+25.0625^{\circ}\text{C}$	0001 1001 0001 0000	1910h
$+10.125^{\circ}\text{C}$	0000 1010 0010 0000	0A20h
$+0.5^{\circ}\text{C}$	0000 0000 1000 0000	0080h
$+0^{\circ}\text{C}$	0000 0000 0000 0000	0000h
-0.5°C	1111 1111 1000 0000	FF80h
-10.125°C	1111 0101 1110 0000	F5E0h
-25.0625°C	1110 0110 1111 0000	E6F0h
-55°C	1100 1001 0000 0000	C900h

OPERATION-Thermostat Control

In its operating mode, the DS1721 functions as a thermostat with programmable hysteresis, as shown in Figure 2. The thermostat output updates as soon as a temperature conversion is complete. When the DS1721's temperature meets or exceeds the value stored in the high temperature trip register (TH), the output becomes active, and will stay active until the temperature is equal to or below the temperature stored in the low temperature trigger register (TL). In this way, any amount of hysteresis may be obtained.

The active state for the totem-pole output is programmable by the user. The power-up default of the DS1721 has $T_H=80^{\circ}\text{C}$, $T_L=75^{\circ}\text{C}$, and the output state active high. Refer to the “OPERATION-Programming” section for instructions in adjusting the thermostat setpoints and T_{COM} active state.

THERMOSTAT OUTPUT OPERATION Figure 2

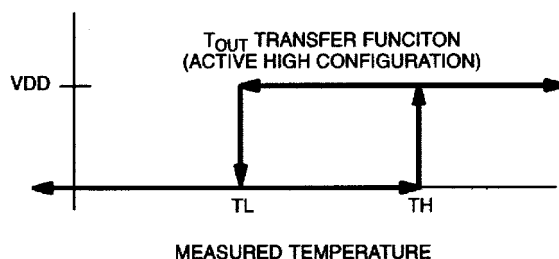

OPERATION-Programming

There are two areas of interest in programming the DS1721: the Configuration/Status register and the thermostat setpoints. All programming is done via the 2-wire interface using the protocols discussed in the “Command Set” section.

Configuration/Status Register Programming

The configuration/status register is accessed via the Access Config (ACh) function command. Writing to or reading from the register is determined by the R/\bar{W} bit of the 2-wire control byte (See “2-wire Serial Data Bus” section). Data is read from or written to the configuration register MSb first. The format of the register is illustrated below in Figure 3. The effect each bit has on DS1721 functionality is described below along with the power-up state of the bit and its ability to be read or written to. The entire register is volatile and will always power-up in the default state. Therefore, it is recommended that the user issue any configuration programming commands immediately after power is cycled, before any other commands are issued.

CONFIGURATION/STATUS REGISTER Figure 3

DONE	X	X	U	R1	R0	POL	1SHOT
MSb							LSb

1SHOT = Temperature Conversion Mode. If 1SHOT is "1", the DS1721 will perform and store one temperature conversion upon reception of the Start Convert T (51h) command. If 1SHOT is "0", the DS1721 will continuously perform temperature conversions and store the last completed result in the Thermometer Register. The user has read/write access to the bit and the power-up default state is "0" (continuous mode).

POL = TCOM Polarity Bit. If POL is "1", the active state of the TCOM output will be high. A "0" stored in this location sets the thermostat output to an active low state. The user has read/write access to the POL bit, and the power-up default state is "1" (active high).

U = Undefined. This bit is used internally by the DS1721. It will be a "0" at power-up and will change to a "1" once the Start Convert T [51h] command is issued. This is a “Don’t Care” on a write; i.e. The DS1721 will ignore writes to this location.

R0, R1 = Thermometer Resolution Bits. Table 3 below defines the resolution of the digital thermometer, based on the settings of these two bits. There is a direct tradeoff between resolution and conversion time, as depicted in the DC Electrical Characteristics: Digital Thermometer table. The designer has read/write access to R0 and R1, and the default state is R0="1" and R1="1" (12-bit conversions).

THERMOMETER RESOLUTION CONFIGURATION Table 3

R1	R0	THERMOMETER RESOLUTION	MAX CONVERSION TIME
0	0	9-BIT	93.75ms
0	1	10-BIT	187.5ms
1	0	11-BIT	375ms
1	1	12-BIT	750ms

X = Undefined. These bits are used internally by the DS1721.

DONE = Temperature Conversion Status Bit. "1" = conversion complete and "0" = conversion in progress. The DONE bit is read-only, and the power-up state is "1". In the continuous conversion mode, DONE = "0".

Thermostat Setpoints Programming

The thermostat registers (TH and TL) define the setpoints for operation of the TCOM output. The respective register can be accessed over the 2-wire bus via the Access TH (A1h) or Access TL (A2h) commands. Reading from or writing to the respective register is controlled by the state of the R/\bar{W} bit in the 2-wire control byte (See "2-Wire Serial Data Bus" section).

The format of the TH and TL registers is a 12-bit 2's complement representation of the temperature in °C. The user can program the number of bits (9, 10, 11, or 12) for each TH and TL that correspond to the thermometer resolution configuration chosen. If the 9-bit mode is chosen, for example, the 3 least significant bits of TH and TL will be ignored by the thermostat comparator. The format for both TH and TL is shown in Figure 4. The power-up default of TH is 80°C and that for TL is 75°C.

TEMPERATURE/DATA RELATIONSHIPS Figure 4

S	2^6	2^5	2^4	2^3	2^2	2^1	2^0	MSB
MSb (UNIT = °C) LSb								
2^{-1}	2^{-2}	2^{-3}	2^{-4}	0	0	0	0	LSB

TEMP	DIGITAL OUTPUT (Binary)	DIGITAL OUTPUT (Hex)
+80°C	0101 0000 0000 0000	5000h
+75°C	0100 1011 0000 0000	4B00h
+10.125°C	0000 1010 0010 0000	0A20h
+0.5°C	0000 0000 1000 0000	0080h
+0°C	0000 0000 0000 0000	0000h
-0.5°C	1111 1111 1000 0000	FF80h
-10.125°C	1111 0101 1110 0000	F5E0h
-25.0625°C	1110 0110 1111 0000	E6F0h
-55°C	1100 1001 0000 0000	C900h

If the user does not wish to take advantage of the thermostat capabilities of the DS1721, the 24 bits can be used for general storage of system data that need not be maintained following a power loss. However, the T_{OUT} pin should be left floating if general data is stored in T_H/T_L .

2-WIRE SERIAL DATA BUS

The DS1721 supports a bi-directional 2-wire bus and data transmission protocol. A device that sends data onto the bus is defined as a transmitter, and a device receiving data as a receiver. The device that controls the message is called a “master.” The devices that are controlled by the master are “slaves.” The bus must be controlled by a master device which generates the serial clock (SCL), controls the bus access, and generates the START and STOP conditions. The DS1721 operates as a slave on the 2-wire bus. Connections to the bus are made via the open-drain I/O lines SDA and SCL.

The following bus protocol has been defined (See Figure 5):

- Data transfer may be initiated only when the bus is not busy.
- During data transfer, the data line must remain stable whenever the clock line is HIGH. Changes in the data line while the clock line is high will be interpreted as control signals.

Accordingly, the following bus conditions have been defined:

Bus not busy: Both data and clock lines remain HIGH.

Start data transfer: A change in the state of the data line, from HIGH to LOW, while the clock is HIGH, defines a START condition.

Stop data transfer: A change in the state of the data line, from LOW to HIGH, while the clock line is HIGH, defines the STOP condition.

Data valid: The state of the data line represents valid data when, after a START condition, the data line is stable for the duration of the HIGH period of the clock signal. The data on the line must be changed during the LOW period of the clock signal. There is one clock pulse per bit of data.

Each data transfer is initiated with a START condition and terminated with a STOP condition. The number of data bytes transferred between START and STOP conditions is not limited, and is determined by the master device. The information is transferred byte-wise and each receiver acknowledges with a 9th bit.

Within the bus specifications a regular mode (100 kHz clock rate) and a fast mode (400 kHz clock rate) are defined. The DS1721 works in both modes.

Acknowledge: Each receiving device, when addressed, is obliged to generate an acknowledge after the reception of each byte. The master device must generate an extra clock pulse which is associated with this acknowledge bit.

A device that acknowledges must pull down the SDA line during the acknowledge clock pulse in such a way that the SDA line is stable LOW during the HIGH period of the acknowledge related clock pulse. Of course, setup and hold times must be taken into account. A master must signal an end of data to the slave by not generating an acknowledge bit on the last byte that has been clocked out of the slave. In this case, the slave must leave the data line HIGH to enable the master to generate the STOP condition.

DATA TRANSFER ON 2-WIRE SERIAL BUS Figure 5

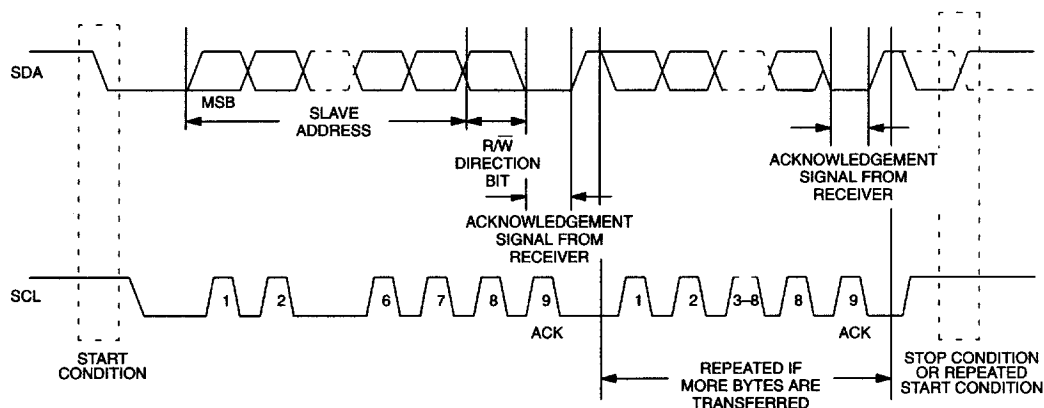

Figure 6 details how data transfer is accomplished on the two-wire bus. Depending upon the state of the $\overline{R/W}$ bit, two types of data transfer are possible:

Data transfer from a master transmitter to a slave receiver. The 1st byte transmitted by the master is the slave address. Next follows a number of data bytes. The slave returns an acknowledge bit after each received byte.

Data transfer from a slave transmitter to a master receiver. The 1st byte (the slave address) is transmitted by the master. The slave then returns an acknowledge bit. Next follows a number of data bytes transmitted by the slave to the master. The master returns an acknowledge bit after all received bytes other than the last byte. At the end of the last received byte, a ‘not acknowledge’ is returned.

The master device generates all of the serial clock pulses and the START and STOP conditions. A transfer is ended with a STOP condition or with a repeated START condition. Since a repeated START condition is also the beginning of the next serial transfer, the bus will not be released.

The DS1721 may operate in the following two modes:

Slave receiver mode: Serial data and clock are received through SDA and SCL. After each byte is received, an acknowledge bit is transmitted. START and STOP conditions are recognized as the beginning and end of a serial transfer. Address recognition is performed by hardware after reception of the slave address and direction bit.

Slave transmitter mode: The first byte is received and handled as in the slave receiver mode. However, in this mode, the direction bit will indicate that the transfer direction is reversed. Serial data is transmitted on SDA by the DS1721 while the serial clock is input on SCL. START and STOP conditions are recognized as the beginning and end of a serial transfer.

2-WIRE SERIAL COMMUNICATION WITH DS1721 Figure 6

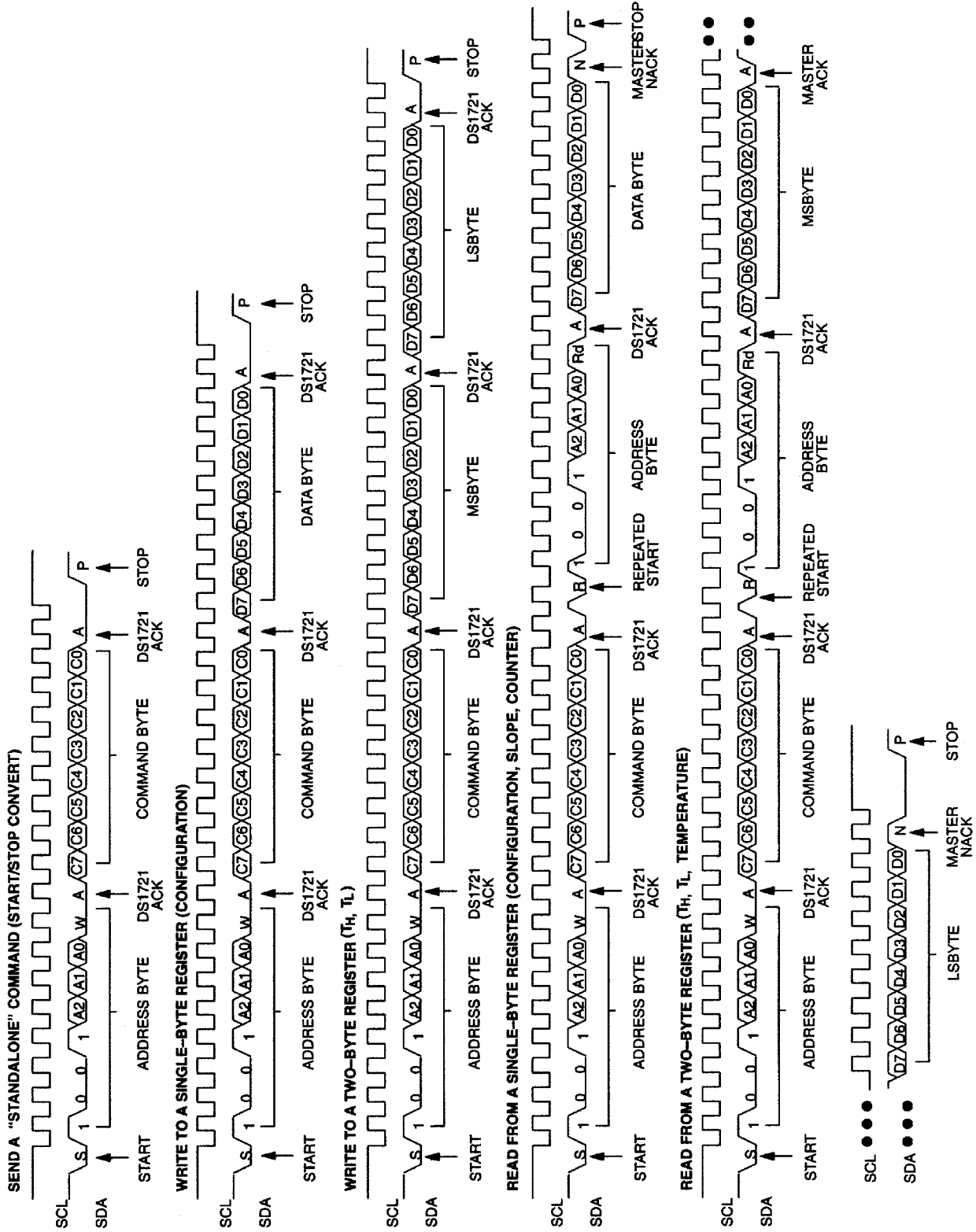

SLAVE ADDRESS

A control byte is the 1st byte received following the START condition from the master device. The control byte consists of a 4-bit control code; for the DS1721, this is set as 1001 binary for read and write operations. The next 3 bits of the control byte are the device select bits (A2, A1, A0). They are used by the master device to select which of eight devices are to be accessed. The set bits are in effect the 3 least significant bits of the slave address. The last bit of the control byte (R/\bar{W}) defines the operation to be performed. When set to a 1 a read operation is selected, and when set to a 0 a write operation is selected. Following the START condition, the DS1721 monitors the SDA bus checking the device type identifier being transmitted. Upon receiving the 1001 code and appropriate device select bits, the slave device outputs an acknowledge signal on the SDA line.

COMMAND SET

Data and control information is read from and written to the DS1721 in the format shown in Figure 6. To write to the DS1721, the master will issue the slave address of the DS1721 and the R/\bar{W} bit will be set to "0". After receiving an acknowledge, the bus master provides a command protocol. After receiving this protocol, the DS1721 will issue an acknowledge and the master may send data to the DS1721. If the DS1721 is to be read, the master must send the command protocol as before then issue a repeated START condition and the control byte again, this time with the R/\bar{W} bit set to "1" to allow reading of the data from the DS1721. The command set for the DS1721 as shown in Table 4 is as follows:

Read Temperature [AAh]

This command reads the last temperature conversion result from the Thermometer Register in the format described in the "OPERATION-Measuring Temperature" section. If one's application can accept thermometer resolution of only 1.0°C, the master only must read the first data byte and follow with a NACK and STOP. For higher resolution, both bytes must be read.

Access TH [A1h]

If R/\bar{W} is "0", this command writes to the TH register. After issuing this command, the next 2 bytes written to the DS1721, in the format described for thermostat set-points, will set the high temperature threshold for operation of the TOUT output. If R/\bar{W} is "1", the value stored in this register is read back.

Access TL [A2h]

If R/\bar{W} is "0", this command writes to the TL register. After issuing this command, the next 2 bytes written to the DS1721, in the format described for thermostat set-points, will set the high temperature threshold for operation of the TOUT output. If R/\bar{W} is "1", the value stored in this register is read back.

Access Config [ACh]

If R/\bar{W} is "0", this command writes to the configuration register. After issuing this command, the next data byte value is to be written into the configuration register. If R/\bar{W} is "1", the next data byte read is the value stored in the configuration register.

Start Convert T [51h]

This command begins a temperature conversion. No further data is required. In one-shot mode, the temperature conversion will be performed and stored and then the DS1721 will remain idle. In continuous mode, this command will initiate continuous conversions.

Stop Convert T [22h]

This command stops temperature conversion. No further data is required. This command may be used to halt a DS1721 in continuous conversion mode. After issuing this command, the current temperature measurement will be completed, stored and the DS1721 will remain idle until a Start Convert T is issued to resume conversions.

DS1721 COMMAND SET Table 4

INSTRUCTION	DESCRIPTION	PROTOCOL	2-WIRE BUS DATA AFTER ISSUING PROTOCOL	NOTES
REGISTER COMMANDS				
Access Configuration	Writes to/Reads from 8-bit configuration/status register	ACh	1 data byte	1
Access TH	Writes to/Reads from 12-bit TH register	A1h	1 or 2 data bytes	1, 3
Access TL	Writes to/Reads from 12-bit TL register	A2h	1 or 2 data bytes	1, 3
CONVERSION COMMANDS				
Start Convert T	Initiates temperature conversion	51h	idle	2
Stop Convert T	Terminates continuous conversions	22h	idle	2
Read Temperature	Reads 12-bit Temperature register	AAh	Read 1 or 2 data bytes	3

NOTES:

1. Data direction depends upon R/\bar{W} bit in the 2-wire control byte.
2. In continuous conversion mode, a Stop Convert T command will halt continuous conversion. To restart, the Start Convert T command must be issued. In one-shot mode, a Start Convert T command must be issued for every temperature reading desired.
3. If the user only desires 8-bit thermometer readings, the master need only read 1 data byte and follow with a NACK and STOP. If higher resolution is required, 2 bytes must be read.

SAMPLE COMMAND SEQUENCE Table 5

Example: After power-up, initiates a temperature conversion, bus master reads temperature

BUS MASTER MODE	DS1721 MODE	DATA (MSB FIRST)	COMMENTS
TX	RX	START	Bus Master initiates a START condition
TX	RX	<address, 0>	Bus Master sends DS1721 address; $R/\bar{W} = 0$
RX	TX	ACK	DS1721 generates acknowledge bit
TX	RX	51h	Bus Master sends start convert T protocol
RX	TX	ACK	DS1721 generates acknowledge bit
TX	RX	START	Bus Master initiates a repeated START condition
TX	RX	<address, 0>	Bus Master sends DS1721 address; $R/\bar{W} = 0$
RX	TX	ACK	DS1721 generates acknowledge bit
TX	RX	AAh	Bus Master sends read temperature protocol
RX	TX	ACK	DS1721 generates acknowledge bit
TX	RX	START	Bus Master initiates a repeated START condition
TX	RX	<address, 1>	Bus Master sends DS1721 address; $R/\bar{W} = 1$
RX	TX	ACK	DS1721 generates acknowledge bit
RX	TX	<1 data byte>	DS1721 transmits MSB of temperature
TX	RX	ACK	Bus Master generates acknowledge bit
RX	TX	<1 data byte>	DS1721 transmits LSB of temperature

SAMPLE COMMAND SEQUENCE Table 6

Example: Bus master programs the DS1721 for 11-bit conversions in the continuous mode with an active low state for the thermostat output. It then programs TH=50°C and TL=45°C and starts temperature conversions.

BUS MASTER MODE	DS1721 MODE	DATA (MSB FIRST)	COMMENTS
TX	RX	START	Bus Master initiates a START condition
TX	RX	<address, 0>	Bus Master sends DS1721 address; $R/\overline{W} = 0$
RX	TX	ACK	DS1721 generates acknowledge bit
TX	RX	ACh	Bus Master sends access configuration protocol
RX	TX	ACK	DS1721 generates acknowledge bit
TX	RX	08h	Bus Master programs configuration register as described above. This will also clear thermostat flags
RX	TX	ACK	DS1721 generates acknowledge bit
TX	RX	START	Bus Master Initiates a REPEATED START condition
TX	RX	<address, 0>	Bus Master sends DS1721 address; $R/\overline{W} = 0$
RX	TX	ACK	DS1721 generates acknowledge bit
TX	RX	A1h	Bus Master sends access TH protocol
RX	TX	ACK	DS1721 generates acknowledge bit
TX	RX	32h	Bus Master writes MSB of TH (50°C)
RX	TX	ACK	DS1721 generates acknowledge bit
TX	RX	00h	Bus Master writes LSB of TH (50°C)
RX	TX	ACK	DS1721 generates acknowledge bit
TX	RX	START	Bus Master initiates a REPEATED START condition
TX	RX	<address, 0>	Bus Master sends DS1721 address; $R/\overline{W} = 0$
RX	TX	ACK	DS1721 generates acknowledge bit
TX	RX	A2h	Bus Master sends access TL protocol
RX	TX	ACK	DS1721 generates acknowledge bit
TX	RX	2Dh	Bus Master writes MSB of TL (45°C)
RX	TX	ACK	DS1721 generates acknowledge bit
TX	RX	00h	Bus Master writes LSB of TL (45°C)
RX	TX	ACK	DS1721 generates acknowledge bit
TX	RX	START	Bus Master initiates a REPEATED START condition
TX	RX	<address, 0>	Bus Master sends DS1721 address; $R/\overline{W} = 0$
RX	TX	ACK	DS1721 generates acknowledge bit
TX	RX	51h	Bus Master sends start convert protocol
RX	TX	ACK	DS1721 generates acknowledge bit
TX	RX	STOP	Bus Master initiates STOP condition

ABSOLUTE MAXIMUM RATINGS*

Voltage on VDD, Relative to Ground	-0.3V to +6.0V
Voltage on any other pin, Related to Ground	-0.3V to +6.0V
Operating Temperature	-55°C to +125°C
Storage Temperature	-55°C to +125°C
Soldering Temperature	260°C for 10 seconds

* This is a stress rating only and functional operation of the device at these or any other conditions above those indicated in the operation sections of this specification is not implied. Exposure to absolute maximum rating conditions for extended periods of time may affect reliability.

RECOMMENDED DC OPERATING CONDITIONS

(-55°C to +125°C; $2.7V \leq V_{DD} \leq 5.5V$)

PARAMETER	SYMBOL	CONDITION	MIN	TYP	MAX	UNITS	NOTES
Supply Voltage	V_{DD}		2.7		5.5	V	1

DC ELECTRICAL CHARACTERISTICS

(-55°C to +125°C; $2.7V \leq V_{DD} \leq 5.5V$)

PARAMETER	SYMBOL	CONDITION	MIN	TYP	MAX	UNITS	NOTES
Input Logic High	V_{IH}		0.7 V_{DD}		V_{DD} +0.3	V	1
Input Logic Low	V_{IL}		-0.5		0.3 V_{DD}	V	1
SDA Output Logic Low Voltage	V_{OL1}	3 mA sink current	0		0.4	V	1
	V_{OL2}	6 mA sink current	0		0.6	V	1
T_{OUT} Output Logic Voltage	V_{OH}	1 mA source current	2.4			V	1
	V_{OL}	4 mA sink current			0.4	V	1
Input Current Each I/O Pin		$0.4V \leq V_{I/O} \leq 0.9 V_{DD}$	-10		+10	μA	2
I/O Capacitance	$C_{I/O}$				10	pF	
Standby Current	I_{DD1}				0.8	μA	3, 4
Active Current	I_{DD}	Temperature Conversions, -55°C to +85°C			1000	μA	3, 4
		+85°C to +125°C			1250		
		Communication only				110	μA
		EEPROM Write			400	μA	3,4

DC ELECTRICAL CHARACTERISTICS: DIGITAL THERMOMETER

(-55°C to +125°C; $2.7V \leq V_{DD} \leq 5.5V$)

PARAMETER	SYMBOL	CONDITION	MIN	TYP	MAX	UNITS	NOTES
DS1721 Thermometer Error	T_{ERR}	-10°C to +85°C, $3.0V \leq V_{DD} \leq 5.5V$			±1.0	°C	
		-10°C to +85°C, $2.7V \leq V_{DD} < 3.0V$			±1.5	°C	
		-55°C to +125°C			±2.0	°C	
Resolution			9		12	bits	
Conversion Time	t_{CONVT}	9-bit Conversions			93.75	ms	
		10-bit Conversions			187.5		
		11-bit Conversions			375		
		12-bit Conversions			750		

AC ELECTRICAL CHARACTERISTICS: 2-WIRE INTERFACE

(-55°C to +125°C; $V_{DD}=2.7V$ to 5.5V)

PARAMETER	SYMBOL	CONDITION	MIN	TYP	MAX	UNITS	NOTES
SCL Clock Frequency	f_{SCL}	Fast Mode Standard Mode	0 0		400 100	KHz	
Bus Free Time Between a STOP and START Condition	t_{BUF}	Fast Mode Standard Mode	1.3 4.7			µs	
Hold Time (Repeated) START Condition	$t_{HD:STA}$	Fast Mode Standard Mode	0.6 4.0			µs	5
Low Period of SCL Clock	t_{LOW}	Fast Mode Standard Mode	1.3 4.7			µs	
High Period of SCL Clock	t_{HIGH}	Fast Mode Standard Mode	0.6 4.0			µs	
Setup Time for a Repeated START Condition	$t_{SU:STA}$	Fast Mode Standard Mode	0.6 4.7			µs	
Data Hold Time	$t_{HD:DAT}$	Fast Mode Standard Mode	0 0		0.9	µs	6
Data Set-up Time	$t_{SU:DAT}$	Fast Mode Standard Mode	100 250			ns	7
Rise Time of both SDA and SCL Signals	t_R	Fast Mode Standard Mode	20+0.1 C_B		300 1000	ns	7
Fall Time of both SDA and SCL Signals	t_F	Fast Mode Standard Mode	20+0.1 C_B		300 1000	ns	8
Set-up time for STOP Condition	$t_{SU:STO}$	Fast Mode Standard Mode	0.6 4.0			µs	

Capacitive Load for each Bus Line	C_b				400	pF	8
Input Capacitance	C_I			5		pF	

NOTES:

- All voltages are referenced to ground.
- I/O pins of fast mode devices must not obstruct the SDA and SCL lines if V_{DD} is switched off.
- I_{DD} specified with T_{OUT} pin open.
- I_{DD} specified with V_{DD} at 5.0V and SDA,SCL = 5.0V, 0°C to 70°C.
- After this period, the first clock pulse is generated.
- The maximum $t_{HD:DAT}$ has only to be met if the device does not stretch the LOW period (t_{LOW}) of the SCL signal.
- A fast mode device can be used in a standard mode system, but the requirement $t_{SU:DAT} > 250$ ns must then be met. This will automatically be the case if the device does not stretch the LOW period of the SCL signal. If such a device does stretch the LOW period of the SCL signal, it must output the next data bit to the SDA line $t_R \text{ MAX} + t_{SU:DAT} \text{ 1000} + 250 = 1250$ ns before the SCL line is released.
- C_b - total capacitance of one bus line in pF.

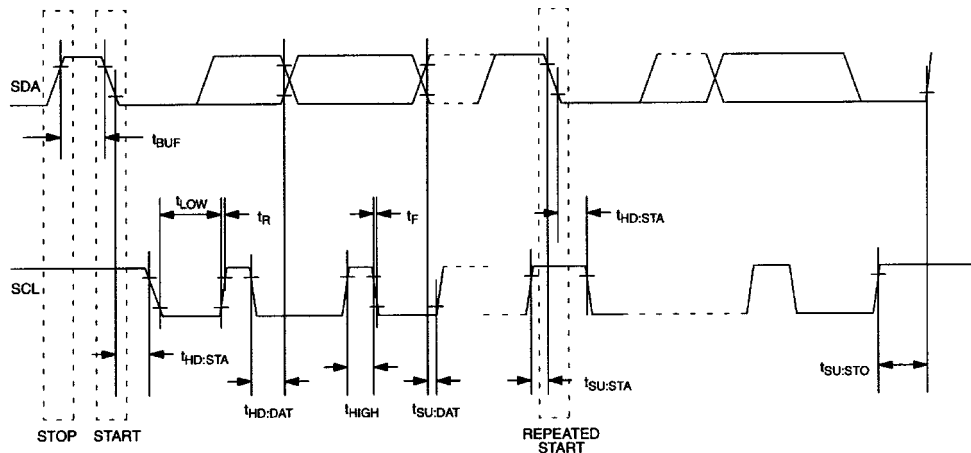
TIMING DIAGRAMS Figure 7

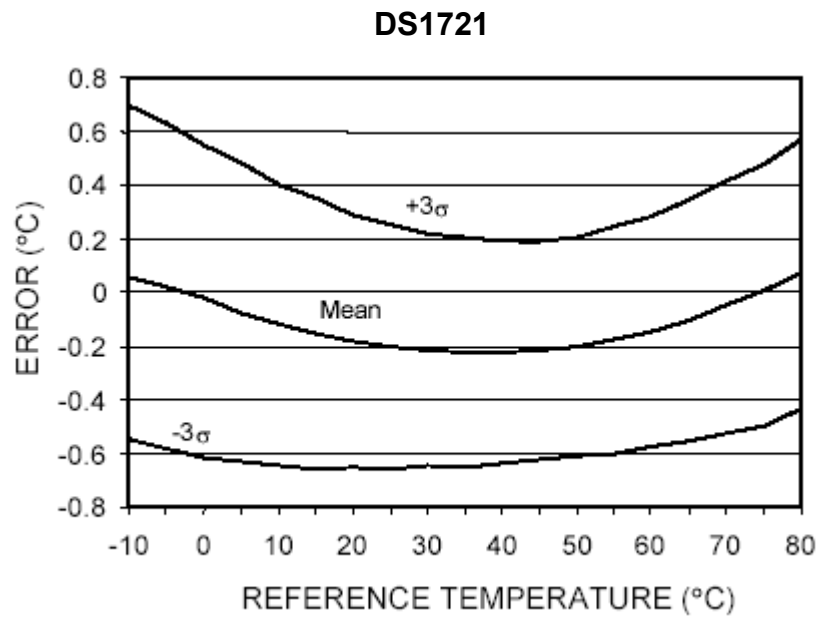
TYPICAL DS1721 THERMOMETER PERFORMANCE CURVE Figure 8

Компания «Life Electronics» занимается поставками электронных компонентов импортного и отечественного производства от производителей и со складов крупных дистрибьюторов Европы, Америки и Азии.

С конца 2013 года компания активно расширяет линейку поставок компонентов по направлению коаксиальный кабель, кварцевые генераторы и конденсаторы (керамические, пленочные, электролитические), за счёт заключения дистрибьюторских договоров

Мы предлагаем:

- Конкуренспособные цены и скидки постоянным клиентам.
- Специальные условия для постоянных клиентов.
- Подбор аналогов.
- Поставку компонентов в любых объемах, удовлетворяющих вашим потребностям.
- Приемлемые сроки поставки, возможна ускоренная поставка.
- Доставку товара в любую точку России и стран СНГ.
- Комплексную поставку.
- Работу по проектам и поставку образцов.
- Формирование склада под заказчика.
- Сертификаты соответствия на поставляемую продукцию (по желанию клиента).
- Тестирование поставляемой продукции.
- Поставку компонентов, требующих военную и космическую приемку.
- Входной контроль качества.
- Наличие сертификата ISO.

В составе нашей компании организован Конструкторский отдел, призванный помогать разработчикам, и инженерам.

Конструкторский отдел помогает осуществить:

- Регистрацию проекта у производителя компонентов.
- Техническую поддержку проекта.
- Защиту от снятия компонента с производства.
- Оценку стоимости проекта по компонентам.
- Изготовление тестовой платы монтаж и пусконаладочные работы.



Тел: +7 (812) 336 43 04 (многоканальный)

Email: org@lifeelectronics.ru