

MIRA-W

~40° wide beam

TECHNICAL SPECIFICATIONS:

Dimensions	Ø 32.4 mm
Height	14.7 mm
Fastening	glue
ROHS compliant	yes ⓘ

MATERIAL SPECIFICATIONS:

Component	Type
MIRA-W	Single lens



Material	Colour	Finish
PC	clear	

ORDERING INFORMATION:

Component

C12501_MIRA-W



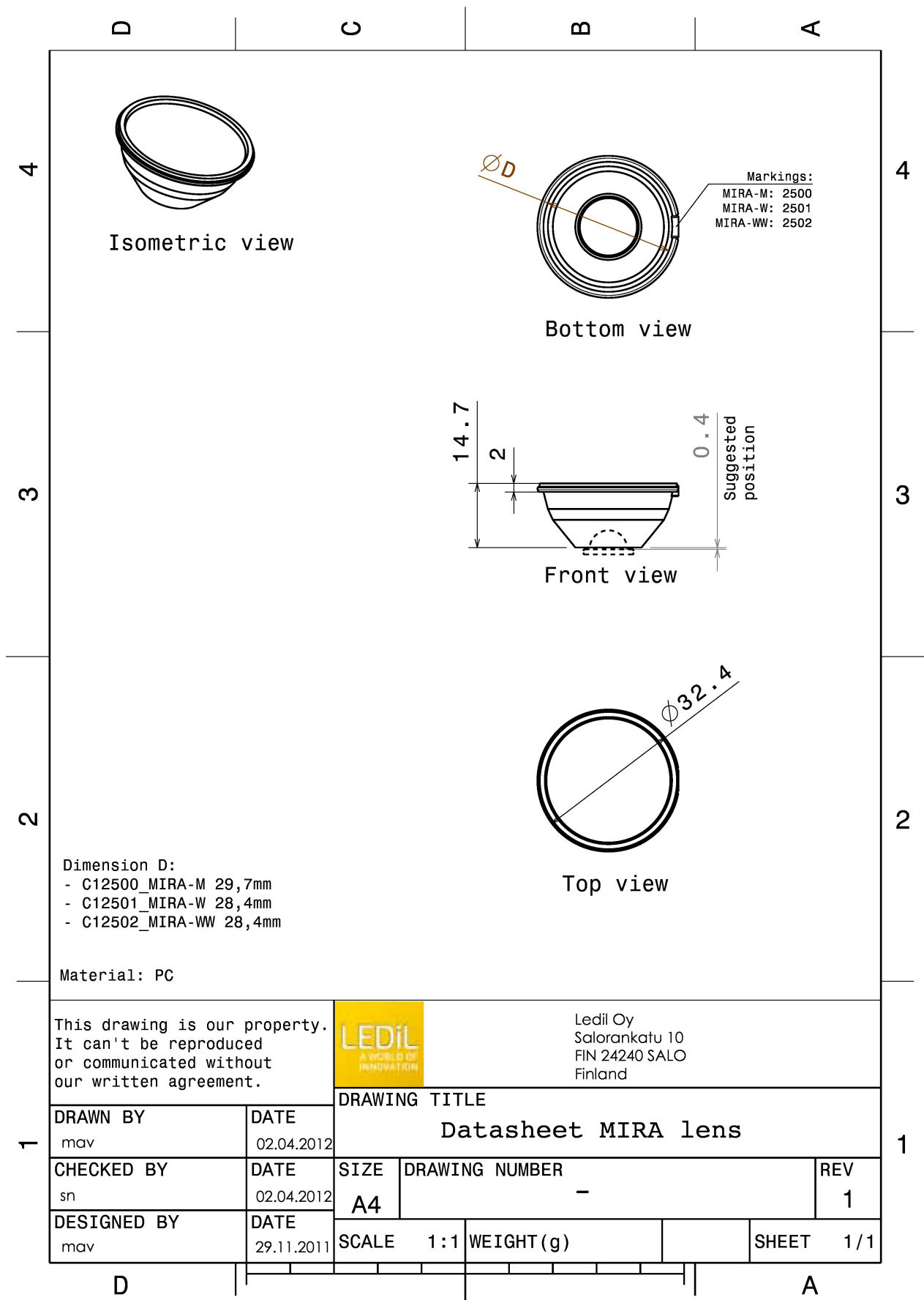

» Box size: 480 x 280 x 300 mm

Qty in box	MOQ	MPQ	Box weight (kg)
840	120	60	7.2

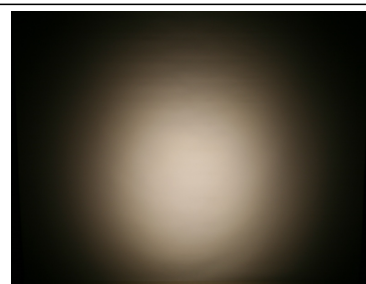

This drawing is our property. It can't be reproduced or communicated without our written agreement.				Ledil Oy Salorankatu 10 FIN 24240 SALO Finland	
DRAWING TITLE		Datasheet MIRA lens			
DRAWN BY mav	DATE 02.04.2012	SIZE A4		DRAWING NUMBER -	REV 1
CHECKED BY sn	DATE 02.04.2012	SCALE 1:1	WEIGHT (g)	SHEET 1/1	
DESIGNED BY mav	DATE 29.11.2011				

PHOTOMETRIC DATA (MEASURED):

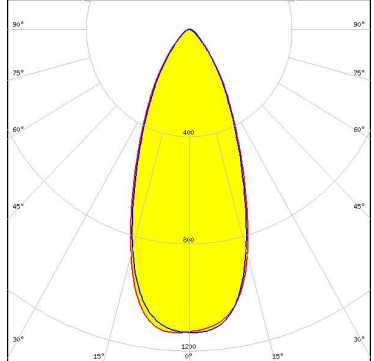
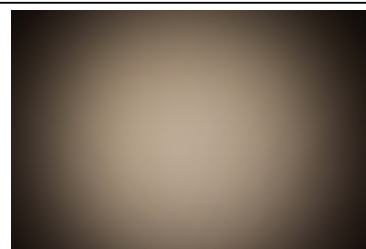
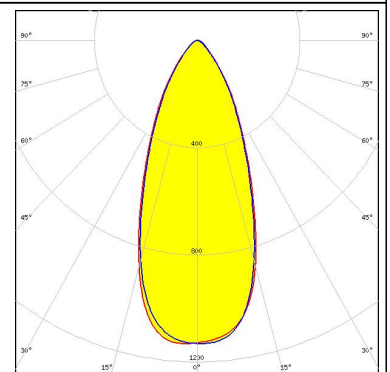
<p></p> <p>LED BXRA ES Star FWHM 39.0° Efficiency 82 % LEDs/each optic 1 Light colour White Required components:</p>	
<p></p> <p>LED V10 Gen6 FWHM 44.0° Efficiency 77 % Peak intensity 1.3 cd/lm LEDs/each optic 1 Light colour White Required components:</p>	
<p></p> <p>LED CXA/B 15xx FWHM 39.0° Efficiency 80 % Peak intensity 1.4 cd/lm LEDs/each optic 1 Light colour White Required components:</p>	
<p></p> <p>LED MHD-E/G FWHM 43.0° Efficiency 81 % Peak intensity 1.1 cd/lm LEDs/each optic 1 Light colour White Required components:</p>	 

PHOTOMETRIC DATA (MEASURED):



LED MT-G
FWHM 38.0°
Efficiency 80 %
Peak intensity 1.4 cd/lm
LEDs/each optic 1
Light colour White
Required components:

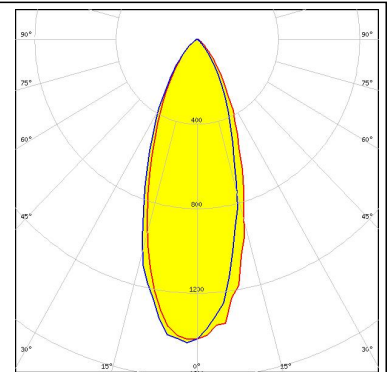
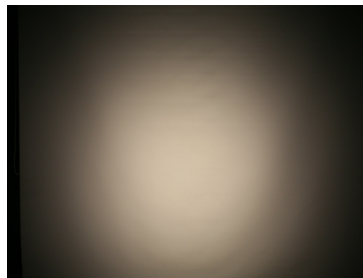

LED XHP70
FWHM 42.0°
Efficiency 80 %
Peak intensity 1.2 cd/lm
LEDs/each optic 1
Light colour White
Required components:

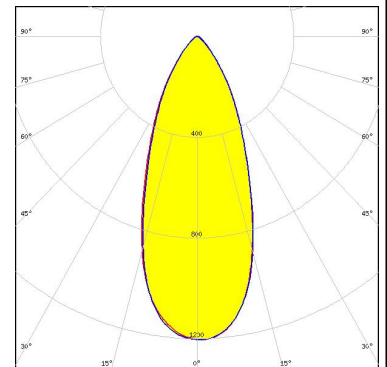
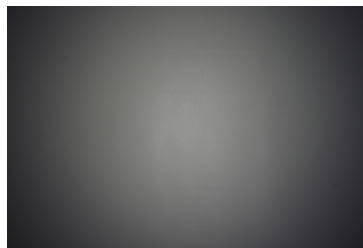

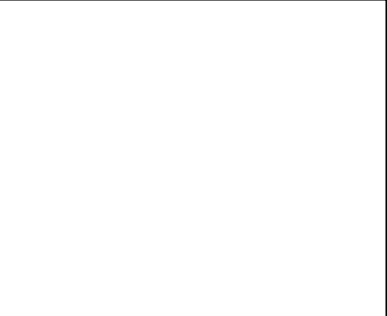
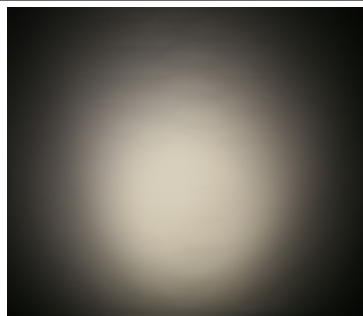

LED LUXEON M/MX
FWHM 39.0°
Efficiency 82 %
LEDs/each optic 1
Light colour White
Required components:

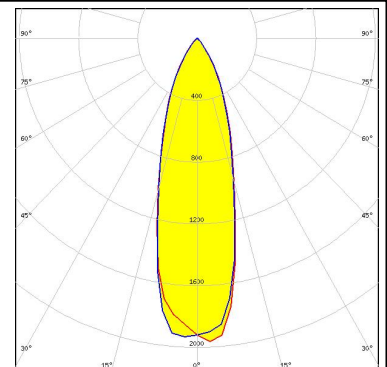
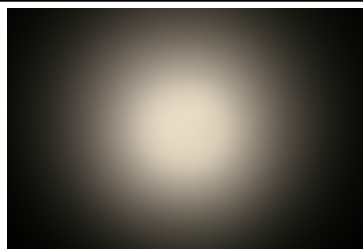

LED LUXEON MZ
FWHM 31.0°
Efficiency 79 %
Peak intensity 2 cd/lm
LEDs/each optic 1
Light colour White
Required components:

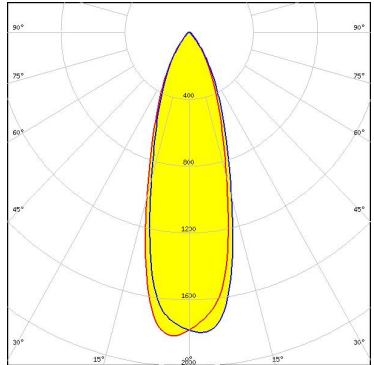
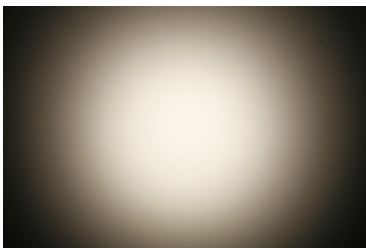
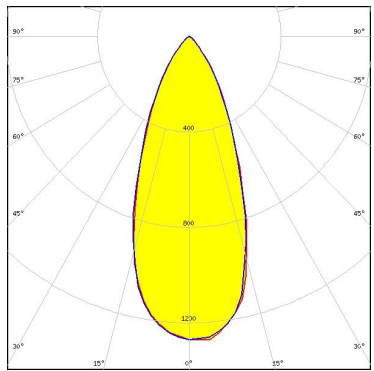
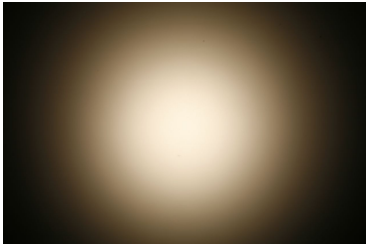
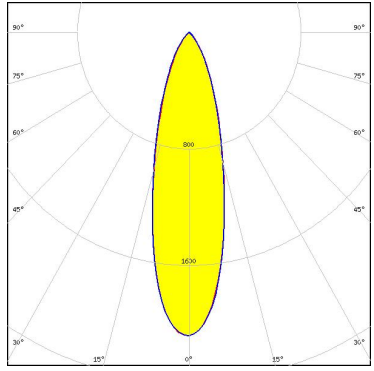
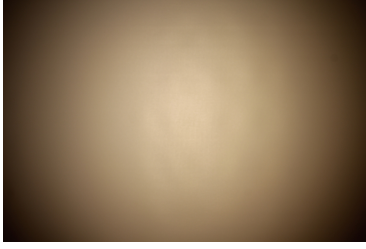

PHOTOMETRIC DATA (MEASURED):

<p>NICHIA</p> <p>LED NFMW48xA FWHM 32.0° Efficiency 80 % Peak intensity 1.8 cd/lm LEDs/each optic 1 Light colour White Required components:</p>		
<p>NICHIA</p> <p>LED NSCxL036A FWHM 42.0° Efficiency 79 % Peak intensity 1.3 cd/lm LEDs/each optic 1 Light colour White Required components:</p>		
<p>NICHIA</p> <p>LED NSMx286M FWHM 28.0° Efficiency 77 % Peak intensity 2.1 cd/lm LEDs/each optic 1 Light colour White Required components:</p>		
<p>OSRAM <small>Opto Semiconductors</small></p> <p>LED Duris S10 FWHM 34.0° Efficiency 83 % Peak intensity 1.9 cd/lm LEDs/each optic 1 Light colour White Required components:</p>		

GENERAL INFORMATION:

NOTE: The typical beam angle will be changed by different color, chip size and chip position tolerance. The typical total beam angle is the full angle measured where the luminous intensity is half of the peak value.

Due to use of high power COB's with this product, special attention to proper thermal design is highly recommended. LEDiL has no liability for direct, indirect or consecutive damages arising from the LEDiL products being used outside of the recommended temperature range.

MATERIALS:

As part of our continuous research and improvement processes, and to ensure the best possible quality and availability of our products, LEDiL reserves the right to change material grades without notice.

PRODUCT DATA USER AGREEMENT AND DISCLAIMER:

The measured data in the provided downloadable LEDiL Product Datasheets and Mechanical 2D-Drawings is rounded and provided as reference for planning. LEDiL Oy's optical specifications have been verified by conducting performance testing of the products in accordance with the company's quality system. The reported data are averaged results of multiple measurements with typical variation. LEDiL Oy reserves the right to without prior notification make changes and improvements to its products.

LEDiL Oy assumes neither warranty, nor guarantee nor any other liability of any kind for the contents and correctness of the provided data. The provided data has been generated with highest diligence but the provided data may in reality not represent the complete possible variation range of all intrinsic parameters. Therefore, in certain cases a deviation from the provided data could occur.

LEDiL Oy reserves the right to undertake technical changes of its products without further notification which could lead to changes in the provided data. LEDiL Oy assumes no liability of any kind for the possible deviation from any provided data or any other damage resulting from the usage of the provided data.

The user agrees to this disclaimer and user agreement with the download or usage of the provided files.

LEDiL Oy

Joensuunkatu 13
FI-24240 SALO
Finland

LEDiL Inc.

228 West Page Street
Suite D
Sycamore IL 60178
USA

Local sales and technical support

[www.ledil.com/
where_to_buy](http://www.ledil.com/where_to_buy)

Shipping locations

Salo, Finland
Hong Kong, China

Distribution Partners

[www.ledil.com/
where_to_buy](http://www.ledil.com/where_to_buy)

Компания «Life Electronics» занимается поставками электронных компонентов импортного и отечественного производства от производителей и со складов крупных дистрибьюторов Европы, Америки и Азии.

С конца 2013 года компания активно расширяет линейку поставок компонентов по направлению коаксиальный кабель, кварцевые генераторы и конденсаторы (керамические, пленочные, электролитические), за счёт заключения дистрибьюторских договоров

Мы предлагаем:

- Конкурентоспособные цены и скидки постоянным клиентам.
- Специальные условия для постоянных клиентов.
- Подбор аналогов.
- Поставку компонентов в любых объемах, удовлетворяющих вашим потребностям.
- Приемлемые сроки поставки, возможна ускоренная поставка.
- Доставку товара в любую точку России и стран СНГ.
- Комплексную поставку.
- Работу по проектам и поставку образцов.
- Формирование склада под заказчика.
- Сертификаты соответствия на поставляемую продукцию (по желанию клиента).
- Тестирование поставляемой продукции.
- Поставку компонентов, требующих военную и космическую приемку.
- Входной контроль качества.
- Наличие сертификата ISO.

В составе нашей компании организован Конструкторский отдел, призванный помогать разработчикам, и инженерам.

Конструкторский отдел помогает осуществить:

- Регистрацию проекта у производителя компонентов.
- Техническую поддержку проекта.
- Защиту от снятия компонента с производства.
- Оценку стоимости проекта по компонентам.
- Изготовление тестовой платы монтаж и пусконаладочные работы.



Тел: +7 (812) 336 43 04 (многоканальный)

Email: org@lifeelectronics.ru