



**TELEDYNE  
RELAYS**

A Teledyne Technologies Company

**HIGH REPEATABILITY  
ULTRAMINIATURE  
BROADBAND  
ATTENUATOR RELAYS**

**SERIES  
GA152**

SERIES DESIGNATION	RELAY TYPE
GA152	Attenuator relay series

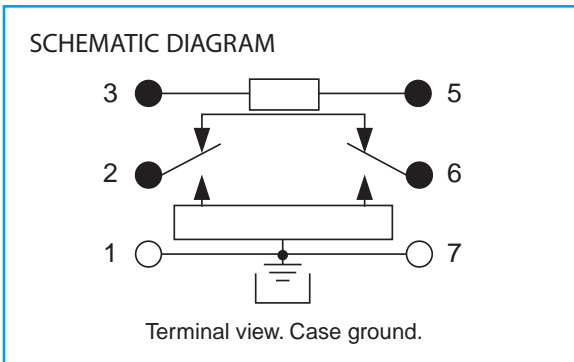

**DESCRIPTION**

The Series GA152 highly repeatable ultraminiature attenuator relays are designed for attenuating RF signals in 50-ohm systems over a frequency range from DC to 5 GHz. Their low profile and small grid spacing makes them ideal for use when packaging density is a prime consideration. The GA152 relays eliminate the need for additional external resistors/attenuators.

These single section, switchable attenuator relays have an internal matched thin film attenuator pad in a "Pi" configuration. Relays are available in a fixed increment of 20 dB.

The GA152 attenuator relay features:

- High repeatability.
- Unique uni-frame motor design which provides high magnetic efficiency and mechanical rigidity.
- Minimum mass components and welded construction for maximum resistance to shock and vibration.
- Advanced cleaning techniques which assures internal cleanliness.
- Gold plated, precious metal contacts, which provide excellent intermodulation performance.
- Flat amplitude vs. frequency response.
- High isolation between control and signal path.
- Stable attenuation vs. temperature.
- Excellent phase linearity.
- Highly resistant to ESD.

Patent No. 5,315,273

ENVIRONMENTAL AND PHYSICAL SPECIFICATIONS		
Temperature (Ambient)	Storage	-65°C to +125°C
	Operating	-55°C to +85°C
Vibration (General Note 1)		10 g's to 500 Hz
Shock (General Note 1)		30 g's, 6ms half sine
Enclosure		Hermetically sealed
Weight		0.11 oz. (3.2g) max.

SERIES GA152  
 GENERAL PERFORMANCE (-55°C to +85°C, unless otherwise specified)

PARAMETER	MINIMUM	TYPICAL	MAXIMUM	UNITS
Operating Frequency (Note 2)	0.0		5.0	GHz
Power (Notes 5 and 6)			1.0	Watt
Impedance		50		Ohms

ELECTRICAL SPECIFICATION (-55°C to +85°C, unless otherwise specified)

PART NUMBER (Note 7)		GA152-dB-5	GA152-dB-12	GA152-dB-15	GA152-dB-26
Coil Voltage Vdc (Note 6)	Nom.	5	12	15	26.5
	Max.	5.8	16.0	20.0	32.0
Coil Resistance Ohms ±20%	@25°C	50	390	610	1560
Pick-up Voltage Vdc Max.	@25°C	3.8	9.0	11.3	18.0
Switching Time ms (Note 8)	Max.	4.0			
	Typ.	2.0			
Insulation Resistance		1,000 MΩ typical (all mutually isolated points)			
Dielectric Strength		300 VRMS / 60 Hz typical (at sea level)			

OUTLINE DIMENSIONS

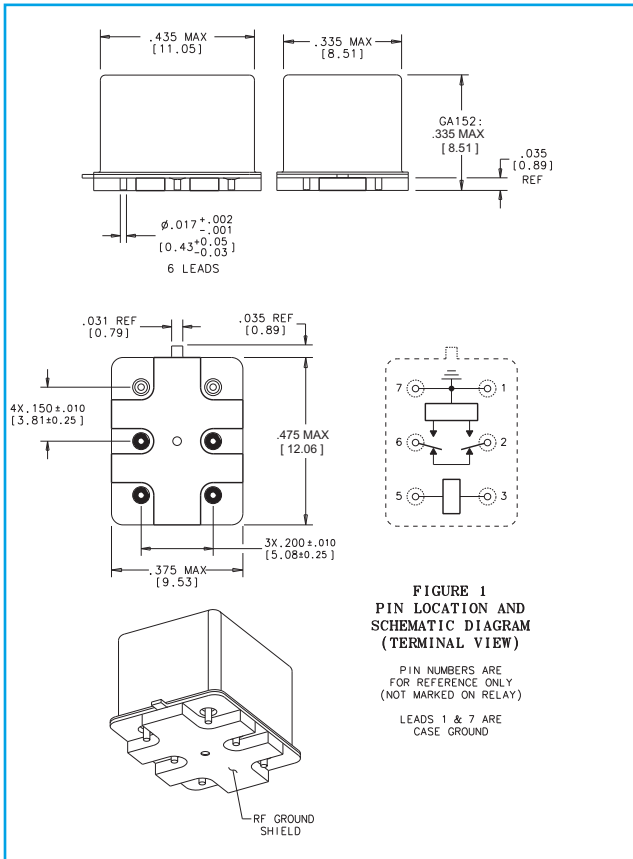

TELEDYNE RELAYS PART NUMBERING SYSTEM  
 FOR GA152 ATTENUATOR RELAYS

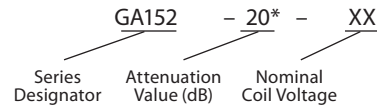

\*Contact factory for additional  
 attenuation values

GENERAL NOTES

1. Contacts will exhibit no contact chatter in excess of 10 μs or transfer in excess of 1 μs.
2. Relays may be operated at higher frequencies with reduced RF performance.
3. For optimal RF performance, solder case to RF ground plane.
4. Attenuation values shown are with reference to the through path (low loss state).
5. Power handling for case temperatures of -55°C to +55°C is 1 Watt. Derate power handling 25 mW/°C above +55°C. Case measurement point is adjacent to the relay tab.
6. Do not operate coil at maximum coil voltage continuously.
7. Insert attenuation value, see part numbering system.
8. Switching time includes bounce.
9. The slash and characters appearing after the slash are not marked on the relay.
10. Unless otherwise specified, relays will be supplied with either gold-plated or solder-coated leads.

RF PERFORMANCE (-55°C to +85°C, unless otherwise specified) (Notes 2, 3 and 4)

PARAMETER	MINIMUM	TYPICAL	MAXIMUM	UNITS	CONDITION
Insertion Loss		0.1	0.25	dB	DC-1 GHz
		0.2	0.35	dB	1-2 GHz
		0.3	.055	dB	2-3 GHz
	See graph				3-5 GHz
VSWR (Through path)		1.10	1.20		DC-1 GHz
		1.20	1.25		1-2 GHz
		1.25	1.30		2-3 GHz
	See graph				3-5 GHz
VSWR (Attenuated path)		1.20	1.25		DC-1 GHz
		1.30	1.35		1-2 GHz
		1.40	1.45		2-3 GHz
	See graph				3-5 GHz

ATTENUATION	MINIMUM	TYPICAL	MAXIMUM	UNITS	CONDITION
20	19.8	20.0	20.2	dB	DC-1 GHz
	19.6	20.0	20.4	dB	1-2 GHz
	19.0	20.0	21.0	dB	2-3 GHz
	See graph				3-5 GHz

Contact factory for additional attenuation values

SERIES GA152  
TYPICAL RF PERFORMANCE (Notes 3 and 4)

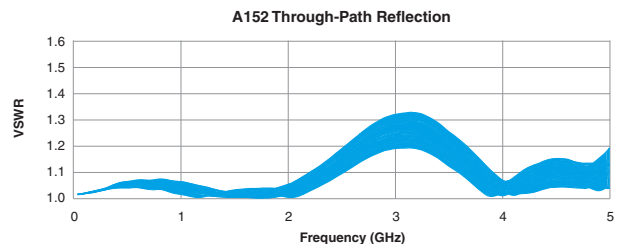
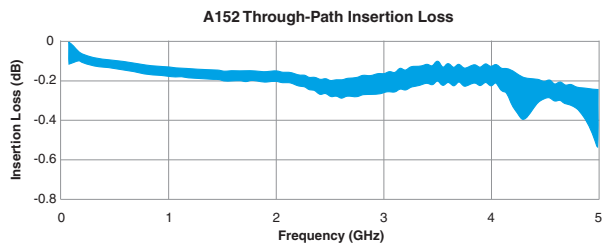
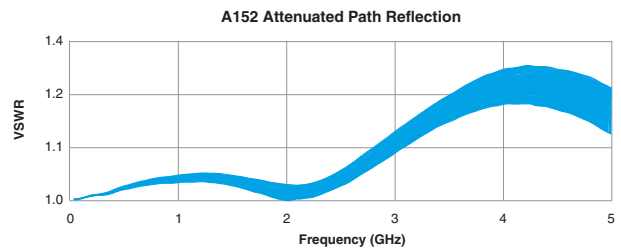
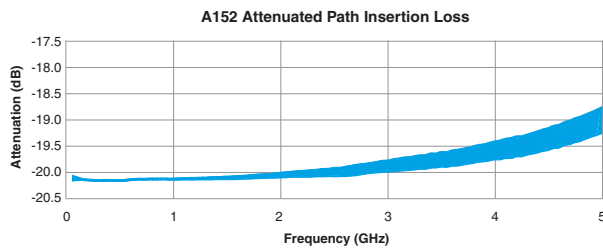

### A152 Insertion Loss Repeatability (Through Path)

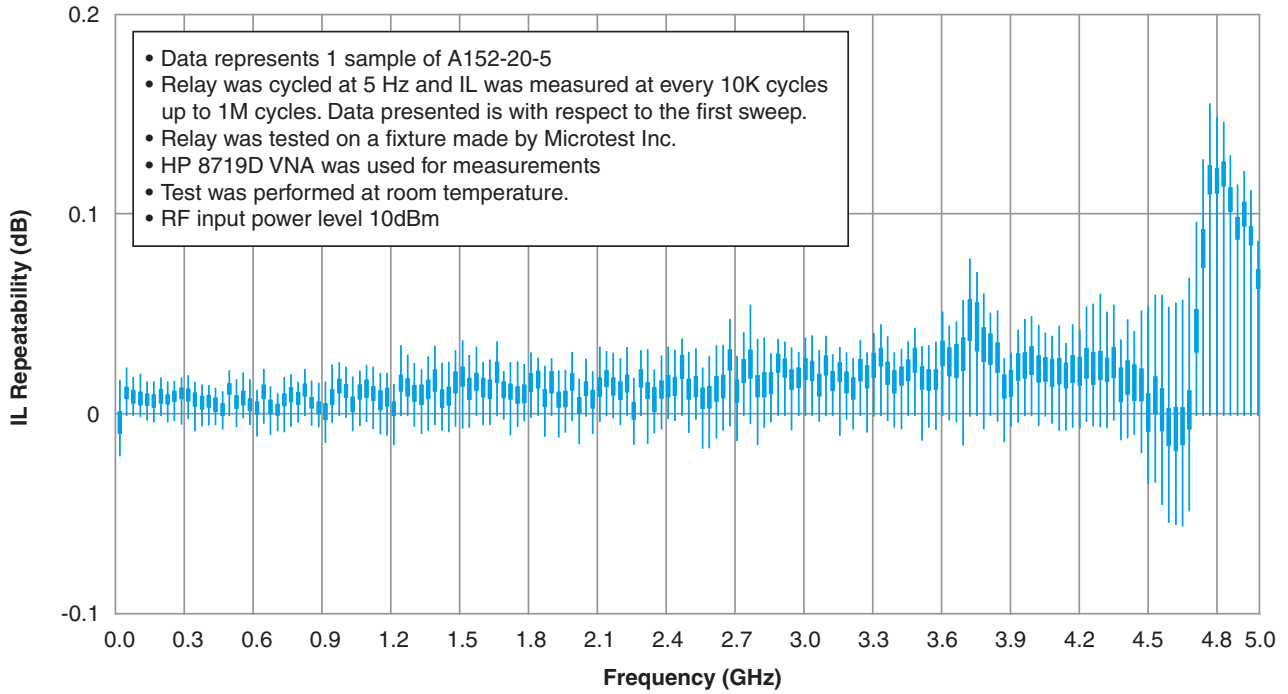

### A152 Insertion Loss Repeatability (Attenuated Path)

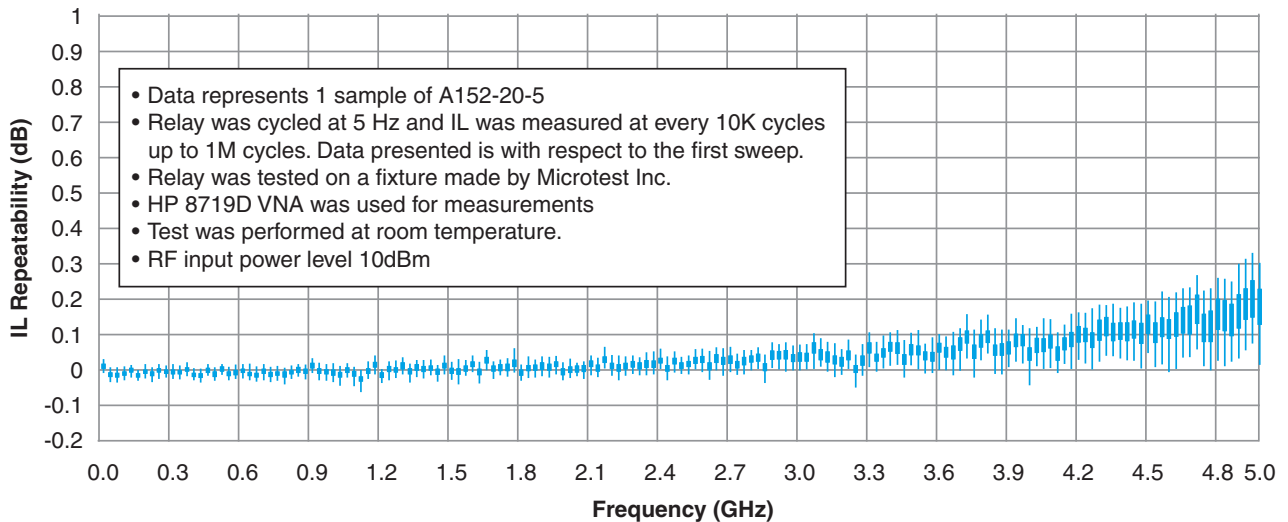

**RF INSERTION LOSS REPEATABILITY NOTES**

1. RF Performance shown is for A152. GA152 RF Data is TBD. RF Performance is the same or better than A152.
2. Test conditions:
  - a. Fixture: Custom plug-in test fixture.
  - b. Relay header is in contact with, but not soldered to, ground plane.
  - c. Test performed at room ambient temperature.
  - d. Contact signal level: 10 dBm.
3. Data presented herein represents typical characteristics and is not intended for use as specification limits.
4. Insertion loss repeatability measured over frequency range from 3 MHz to 5 GHz.

Компания «Life Electronics» занимается поставками электронных компонентов импортного и отечественного производства от производителей и со складов крупных дистрибьюторов Европы, Америки и Азии.

С конца 2013 года компания активно расширяет линейку поставок компонентов по направлению коаксиальный кабель, кварцевые генераторы и конденсаторы (керамические, пленочные, электролитические), за счёт заключения дистрибьюторских договоров

Мы предлагаем:

- Конкурентоспособные цены и скидки постоянным клиентам.
- Специальные условия для постоянных клиентов.
- Подбор аналогов.
- Поставку компонентов в любых объемах, удовлетворяющих вашим потребностям.
- Приемлемые сроки поставки, возможна ускоренная поставка.
- Доставку товара в любую точку России и стран СНГ.
- Комплексную поставку.
- Работу по проектам и поставку образцов.
- Формирование склада под заказчика.
- Сертификаты соответствия на поставляемую продукцию (по желанию клиента).
- Тестирование поставляемой продукции.
- Поставку компонентов, требующих военную и космическую приемку.
- Входной контроль качества.
- Наличие сертификата ISO.

В составе нашей компании организован Конструкторский отдел, призванный помогать разработчикам, и инженерам.

Конструкторский отдел помогает осуществить:

- Регистрацию проекта у производителя компонентов.
- Техническую поддержку проекта.
- Защиту от снятия компонента с производства.
- Оценку стоимости проекта по компонентам.
- Изготовление тестовой платы монтаж и пусконаладочные работы.



Тел: +7 (812) 336 43 04 (многоканальный)

Email: [org@lifeelectronics.ru](mailto:org@lifeelectronics.ru)