

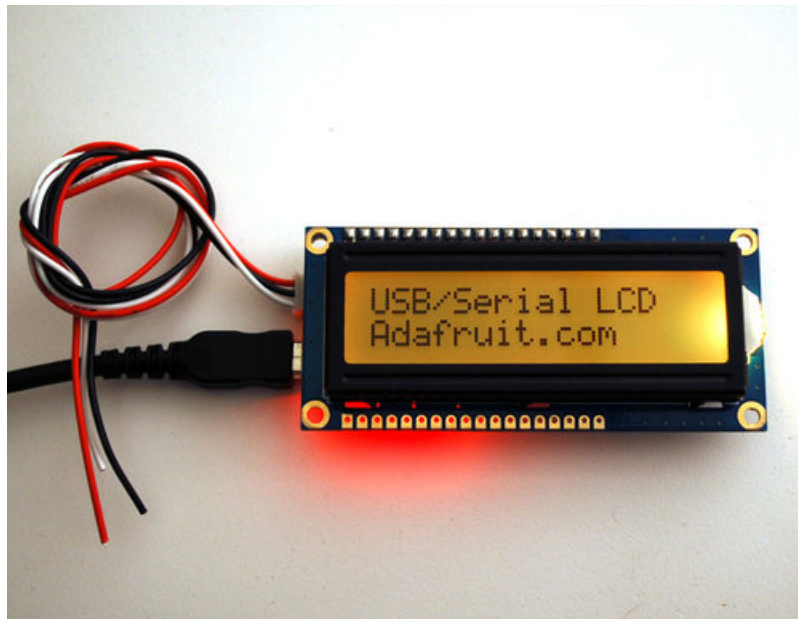

USB + Serial RGB Backlight Character LCD Backpack

Created by Tyler Cooper



Last updated on 2018-08-22 03:33:48 PM UTC

Guide Contents

Guide Contents	2
Overview	3
USB or TTL Serial	5
Assembly	6
Sending Text	10
Testing with USB	11
Testing with TTL Serial	14
Command Reference	17
Downloads	19
Files	19
Drivers	19
Schematic & Fabrication Print	19

Overview

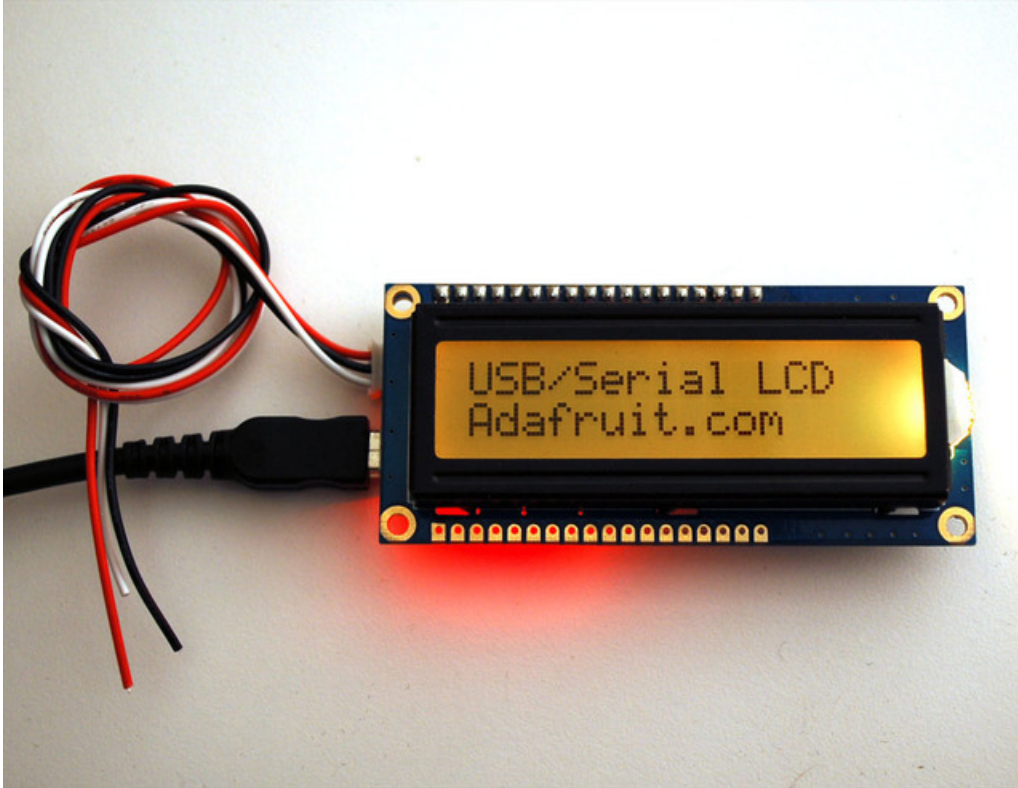

Adding a character display to your project or computer has never been easier with the new Adafruit USB or TTL serial backpack! This custom-designed PCB sits on the back of [any 'standard' character LCD \(16x2 or 20x4 sized\)](https://adafru.it/a1S) (<https://adafru.it/a1S>) and does everything you could want: printing text, automatic scrolling, setting the backlight, adjusting contrast, making custom characters, turning on and off the cursor, etc. It can even handle our RGB backlight LCDs with full 8-bit PWM control of the backlight. That means you can change the background color to anything you want - red, green, blue, pink, white, purple yellow, teal, salmon, chartreuse, or just leave it off for a neutral background.



Inside the backpack is an USB-capable AT90USB162 chip that listens for commands both a mini-B USB port and a TTL serial input wire. The USB interface shows up as a COM/serial port on Windows/Mac/Linux. The backpack will automatically select data from whichever input is being used. For the USB connection, it will work at any baud rate. For the TTL connection, the default baud rate is 9600 but you can send it a command to set the baud rate to 2400, 4800, 9600, 19200, 28800, or 57600 baud. (The baud rate is flashed on the LCD during powerup). Any customizations such as baud rate, backlight color, brightness, splash screen, etc. are stored permanently EEPROM.

The command interface is compatible with the popular "Matrix Orbital" specifications so this backpack will work perfectly with computer applications or libraries that are expecting a "Matrix" LCD. We added a few extra commands for the RGB backlight and setting the LCD size. If you don't want to use the commands, you can just start sending ASCII to the LCD and it will magically appear as typed.

Pick up one from the Adafruit shop today! (<https://adafru.it/aIS>)

USB or TTL Serial

There are two interfaces for transmitting data to the backpack: USB and Serial. USB is the easiest: simply plug a mini-B cable from the backpack to a computer to power and connect. The backpack will appear as a "USB Serial Port" to Windows, Mac and Linux computers. An INF file is required for windows, no driver is required for Mac or Linux. Windows computers will create a **COM** port, Mac/Linux will create a device under `/dev/cu.usbserialXX` or similar, run `dmesg` right after plugging in to see what the device is called. With USB, use any terminal program to connect at any baud rate to the port and send text and command data. The baud rate is not used for USB so just connect at 9600 or whichever is easiest.

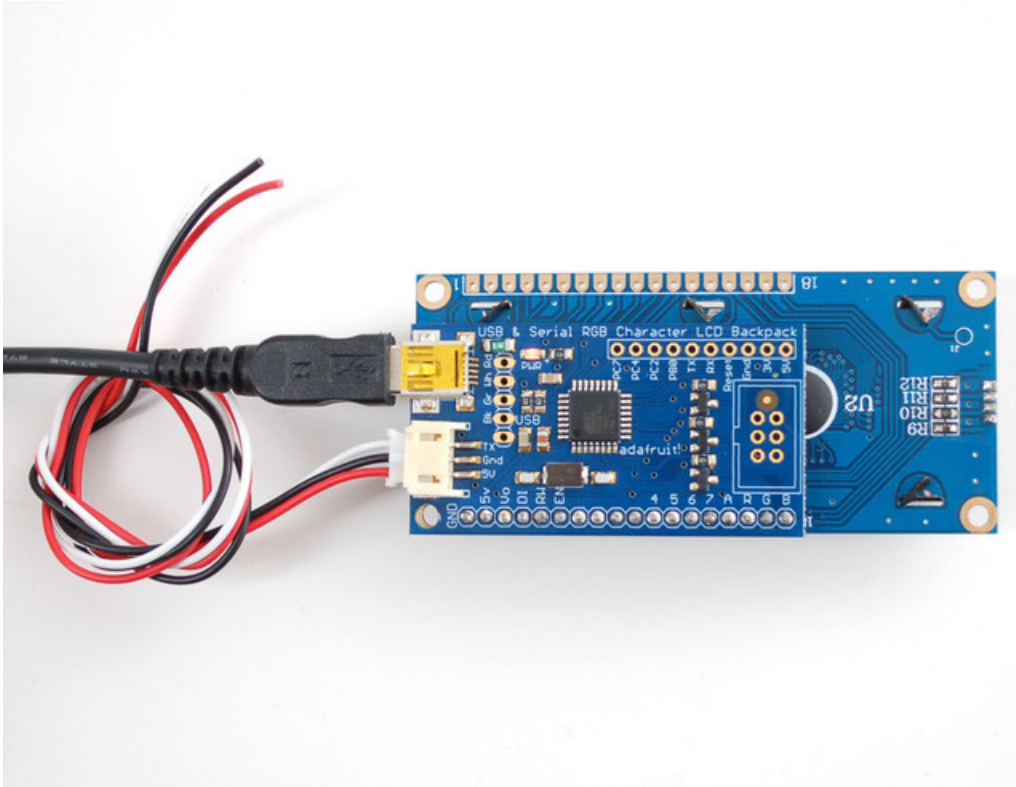

You can also connect with the TTL serial input. This is the red/black/white cable. Power is provided by connecting the black wire to ground and the red wire to +5V. The white cable is the 5V TTL serial input. By default, the backpack is configured for 9600 baud, 8 bit, no parity, 1 stop bit. You can configure the baud rate if you need faster/slower TTL interface. When powered, the backpack will blink the baud rate onto the display for 100 milliseconds so if you're ever really confused, connect while watching the display. You can always connect with USB (baud rate is not used for USB) and reset the baud rate there.

For hard-wiring the USB connection, there is a USB breakout in the standard '5x1' pinout for red, black, white, and green USB wires. For hardwiring the TTL connection, there are breakouts for the RX and TX pin. along the edge of the PCB.

Assembly

The first step is to solder a character LCD display onto the backpack. Remember that only **character** type displays are supported, and they can be up to 20x4 in size but no larger. [All Adafruit character displays work \(https://adafru.it/aIS\)](https://adafru.it/aIS) but we can't guarantee any others will work!

If you buy a kit from adafruit you may get an extra blue 10K potentiometer. This part isn't required for this kit so you can use it for another project!

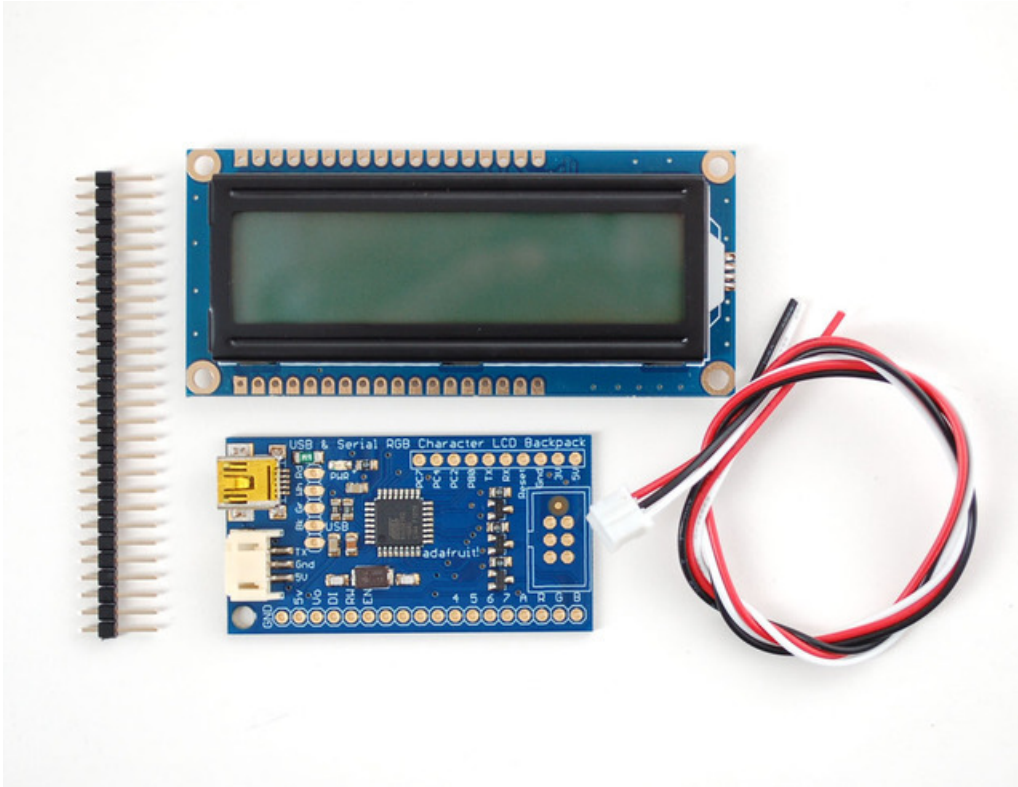

The backpack comes with a piece of header you can use to fit the display on. Its handy to have a solderless breadboard to attach the header on straight.

Your kit may also come with a blue 3-pin potentiometer, this part is not required, you can simply recycle it into another project.

Break off the header so that it matches the number of pins on your LCD.

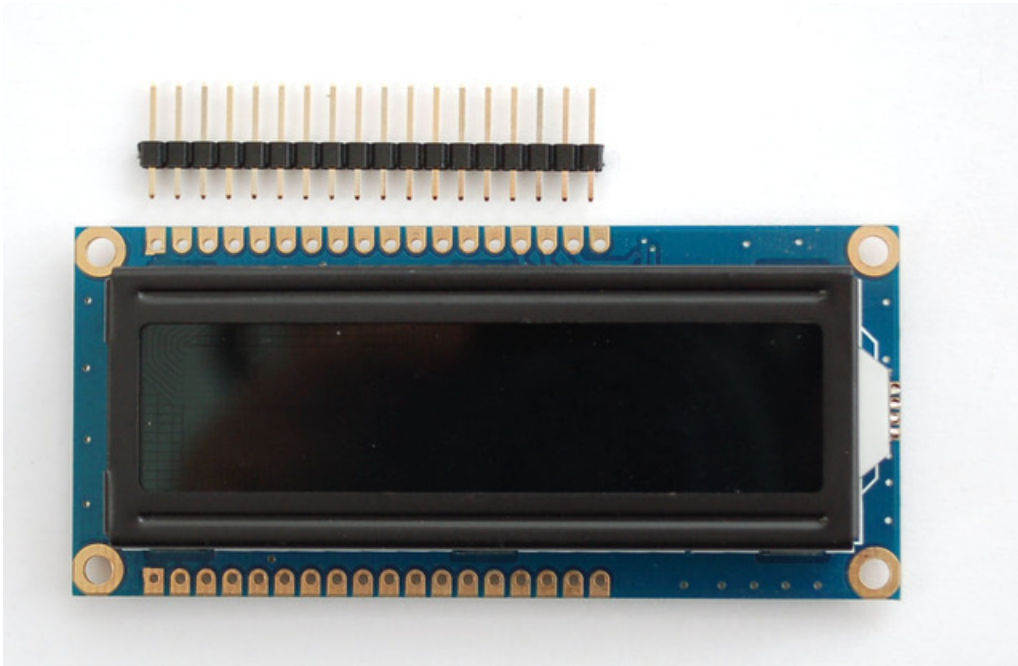

Place the header with the long side down into a breadboard. then place the LCD on top. If you're using an LCD with two rows available, make sure you're using the row that matches the image below.

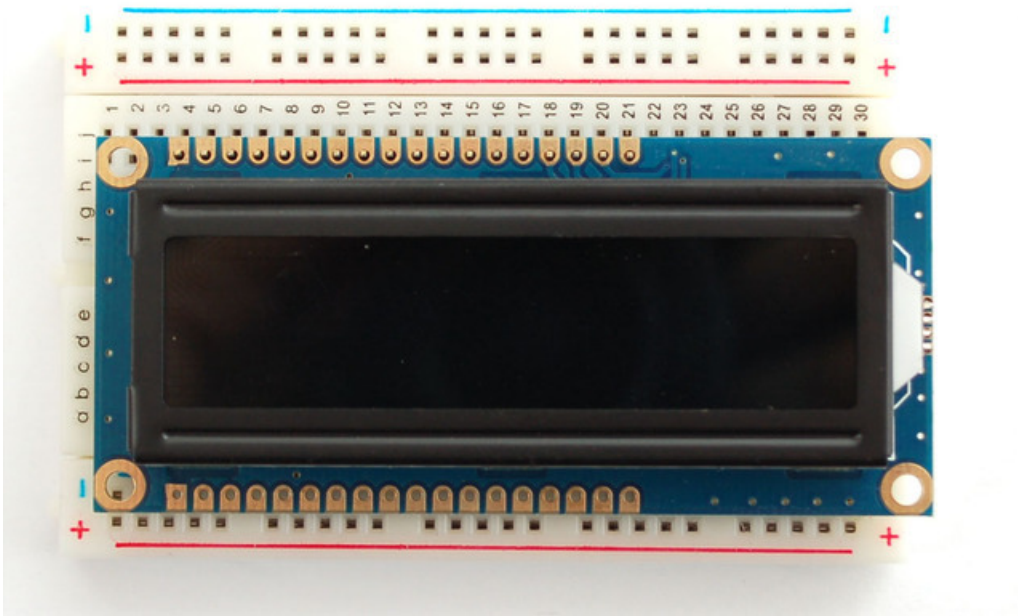

Solder all the headers on with your iron.

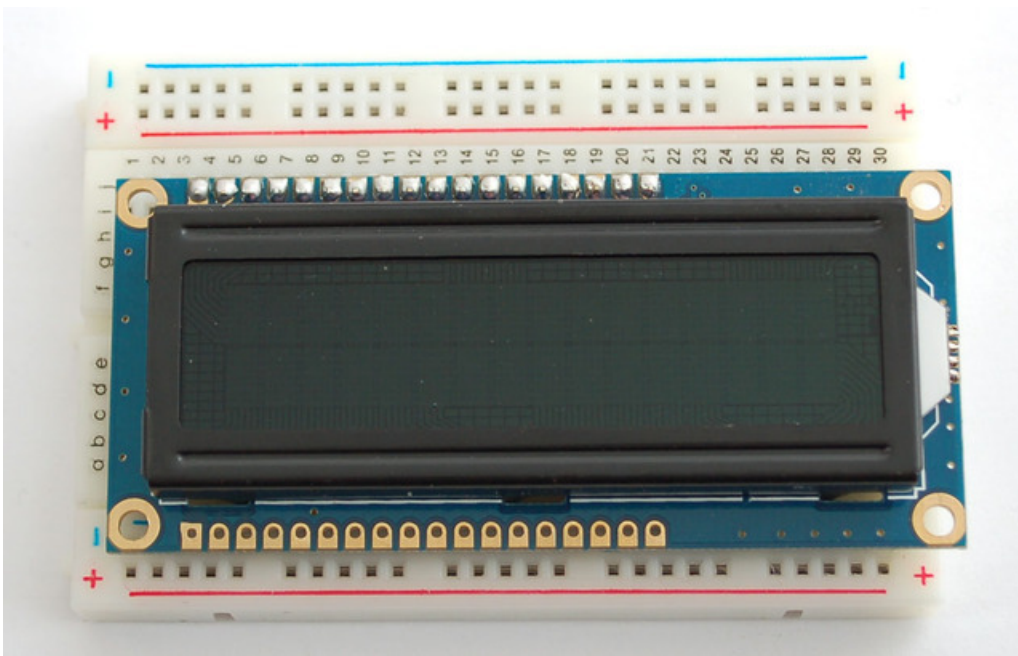
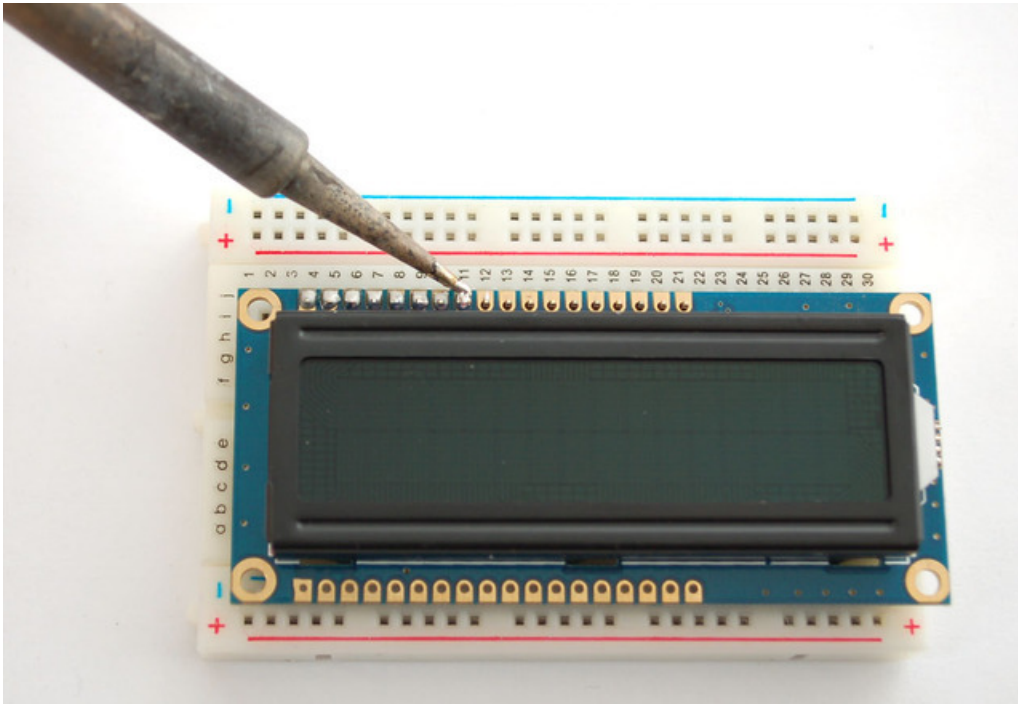

Next, align the backpack so that it matches up with the corner of the LCD, the hole in the backpack should be in the same location.

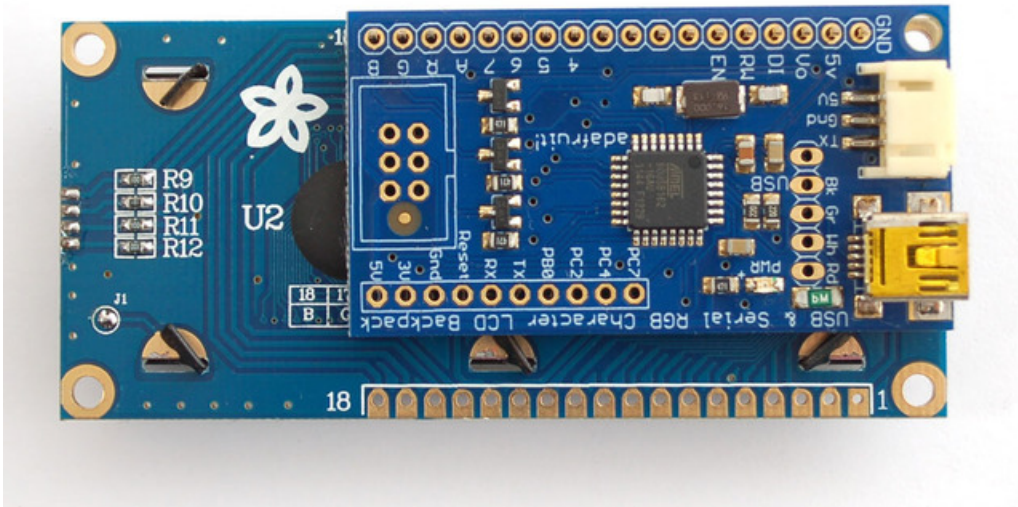

Solder the backpack on completely.

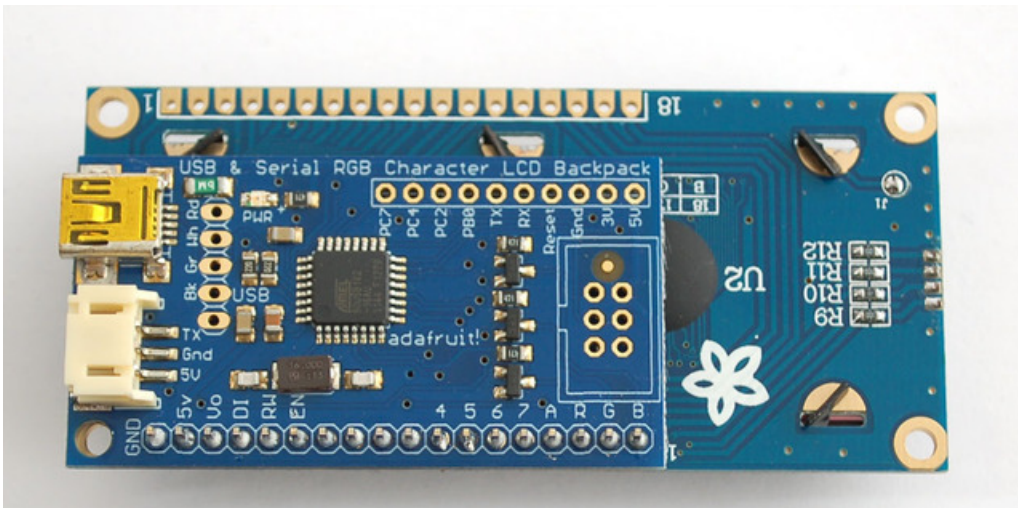

Thats it!

Sending Text

To display text, just send ASCII characters! There are a few special characters to note:

- **New line character (0x0A or '\n')** will fill the rest of the current row with spaces (to blank it) and move to the next line
- **Carriage return (0x0D or '\r')** is not listened to
- **Backspace (0x08)** will back up the character one space and replace the last character with a space to erase it.

There are also a bunch of special commands, see below for how to send those commands below.

The only character that is 'special' is **0xFE** which is the 'command start' character.

Testing with USB

The easiest way to test the LCD and backpack is to connect it to your computer and send data with a terminal program.

Use any mini-B USB cable to connect to the backpack. If you're using windows, you'll need to point it to an INF driver file. See below in the download section for that INF file. Mac and Linux do not require a driver.

After the backpack is plugged in, it will create a serial port. Under windows this is called a **COM port**. You can look in the **Device Manager**→**Ports** to see what the name of the COM port created is. You should see an entry appear/disappear when connecting the USB cable.

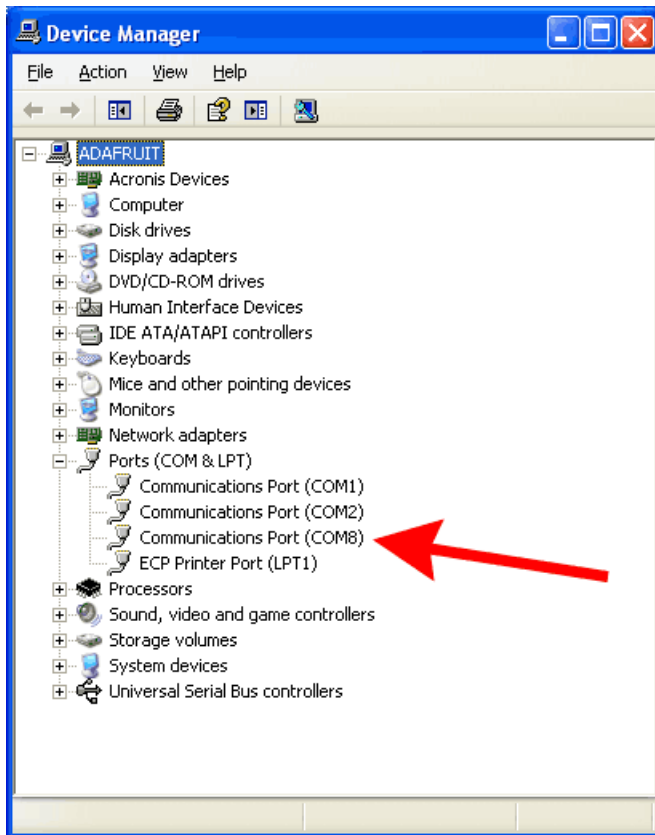

For mac/linux, once you have plugged in the cable, run **dmesg** to see what the name of the port is, probably something like **/dev/cu.usbmodem-XXXX** or similar. You can also type **ls /dev/cu.*** into a **Terminal** window and see what items appear/disappear when the cable is connected and unplugged.

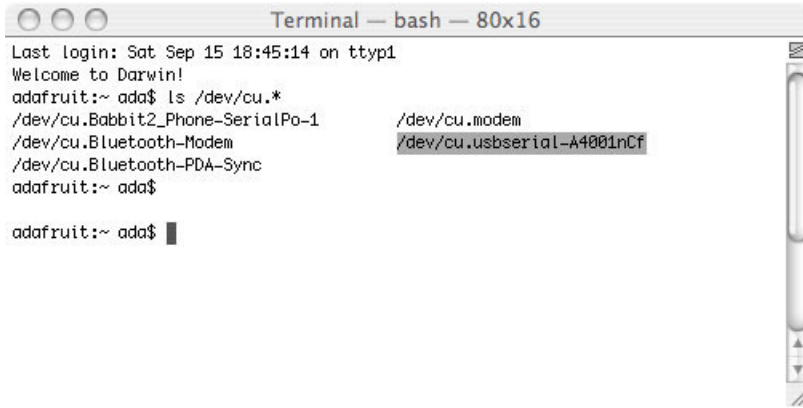

Now that the port is known, you can use your favorite terminal program to connect. For this example, we'll use the basic terminal built into Arduino. The only downside of the serial port monitor is that you can only send a full string at a time and there's a new line at the end. If you are using a more powerful monitor such as CoolTerm (mac) or RealTerm (Windows) you can watch as each character is entered

Start by selecting the same COM serial port that belongs to the backpack.

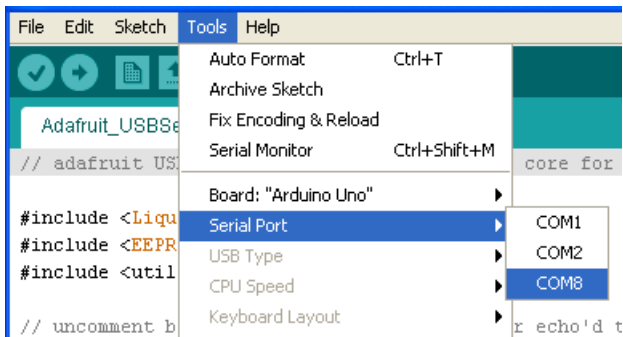

Open the serial port monitor and type Hello World! into the text box.

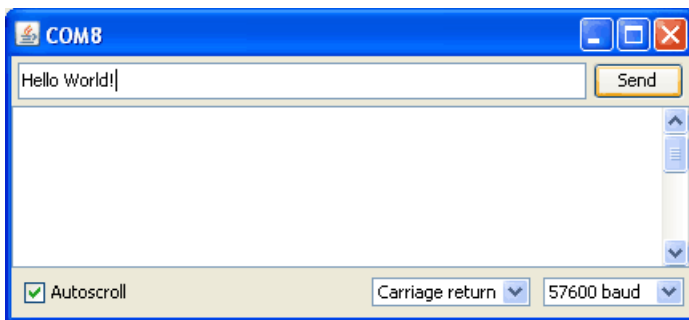

Once you hit **Send** it will transfer the text to the backpack, and it will appear. Thats it!



For more commands, check the github repository (see the Downloads tab) for a python script that will test all commands on the display.

Testing with TTL Serial

Next we will demonstrate how to send text and commands using an Arduino microcontroller. You can of course use any microcontroller that has a serial output you can configure for 9600 baud. This demo will show how to set the display size, RGB backlight and create a custom character. For more commands, see below for the full list of supported commands

Grab an Arduino and connect the JST cable to the backpack as follows: Red wire goes to +5V, Black wire goes to Ground, White data wire goes to digital #2. You can change the digital pin later, but stick with #2 for this example and adjust later as desired.

You can download this example from [this Github repository \(https://adafru.it/jHb\)](https://adafru.it/jHb).

```
#include "Arduino.h"

#if defined(ARDUINO_ARCH_SAMD) || defined(__SAM3X8E__)
  // use pin 18 with Due, pin 1 with Zero or M0 Pro
  #define lcd Serial1
#else
  #include <SoftwareSerial.h>
  // Create a software serial port!
  SoftwareSerial lcd = SoftwareSerial(0,2);
#endif

// for ESP8266 use this SoftwareSerial library: https://github.com/plerup/espssoftwareserial

void setup() {
  lcd.begin(9600);

  // set the size of the display if it isn't 16x2 (you only have to do this once)
  lcd.write(0xFE);
  lcd.write(0xD1);
  lcd.write(16); // 16 columns
  lcd.write(2); // 2 rows
  delay(10);
  // we suggest putting delays after each command to make sure the data
  // is sent and the LCD is updated.

  // set the contrast, 200 is a good place to start, adjust as desired
  lcd.write(0xFE);
  lcd.write(0x50);
  lcd.write(200);
  delay(10);

  // set the brightness - we'll max it (255 is max brightness)
  lcd.write(0xFE);
  lcd.write(0x99);
  lcd.write(255);
  delay(10);

  // turn off cursors
  lcd.write(0xFE);
  lcd.write(0x4B);
  lcd.write(0xFE);
  lcd.write(0x54);
```

```

// create a custom character
lcd.write(0xFE);
lcd.write(0x4E);
lcd.write((uint8_t)0);    // location #0
lcd.write((uint8_t)0x00); // 8 bytes of character data
lcd.write(0x0A);
lcd.write(0x15);
lcd.write(0x11);
lcd.write(0x11);
lcd.write(0x0A);
lcd.write(0x04);
lcd.write((uint8_t)0x00);
delay(10); // we suggest putting delays after each command

// clear screen
lcd.write(0xFE);
lcd.write(0x58);
delay(10); // we suggest putting delays after each command

// go 'home'
lcd.write(0xFE);
lcd.write(0x48);
delay(10); // we suggest putting delays after each command

lcd.print("We ");
lcd.write((uint8_t)0); // to print the custom character, 'write' the location
lcd.println(" Arduino!");
lcd.print("    - Adafruit");

delay(1000);
}

uint8_t red, green, blue;
void loop() {
// adjust colors
for (red = 0; red < 255; red++) {
  lcd.write(0xFE);
  lcd.write(0xD0);
  lcd.write(red);
  lcd.write((uint8_t)0);
  lcd.write(255 - red);
  delay(10); // give it some time to adjust the backlight!
}

for (green = 0; green < 255; green++) {
  lcd.write(0xFE);
  lcd.write(0xD0);
  lcd.write(255-green);
  lcd.write(green);
  lcd.write((uint8_t)0);
  delay(10); // give it some time to adjust the backlight!
}

for (blue = 0; blue < 255; blue++) {
  lcd.write(0xFE);
  lcd.write(0xD0);
  lcd.write((uint8_t)0);
  lcd.write(255-blue);
  lcd.write(blue);
}

```

```
delay(10); // give it some time to adjust the backlight!  
}  
}
```

You should see the following, with a color-changing background:

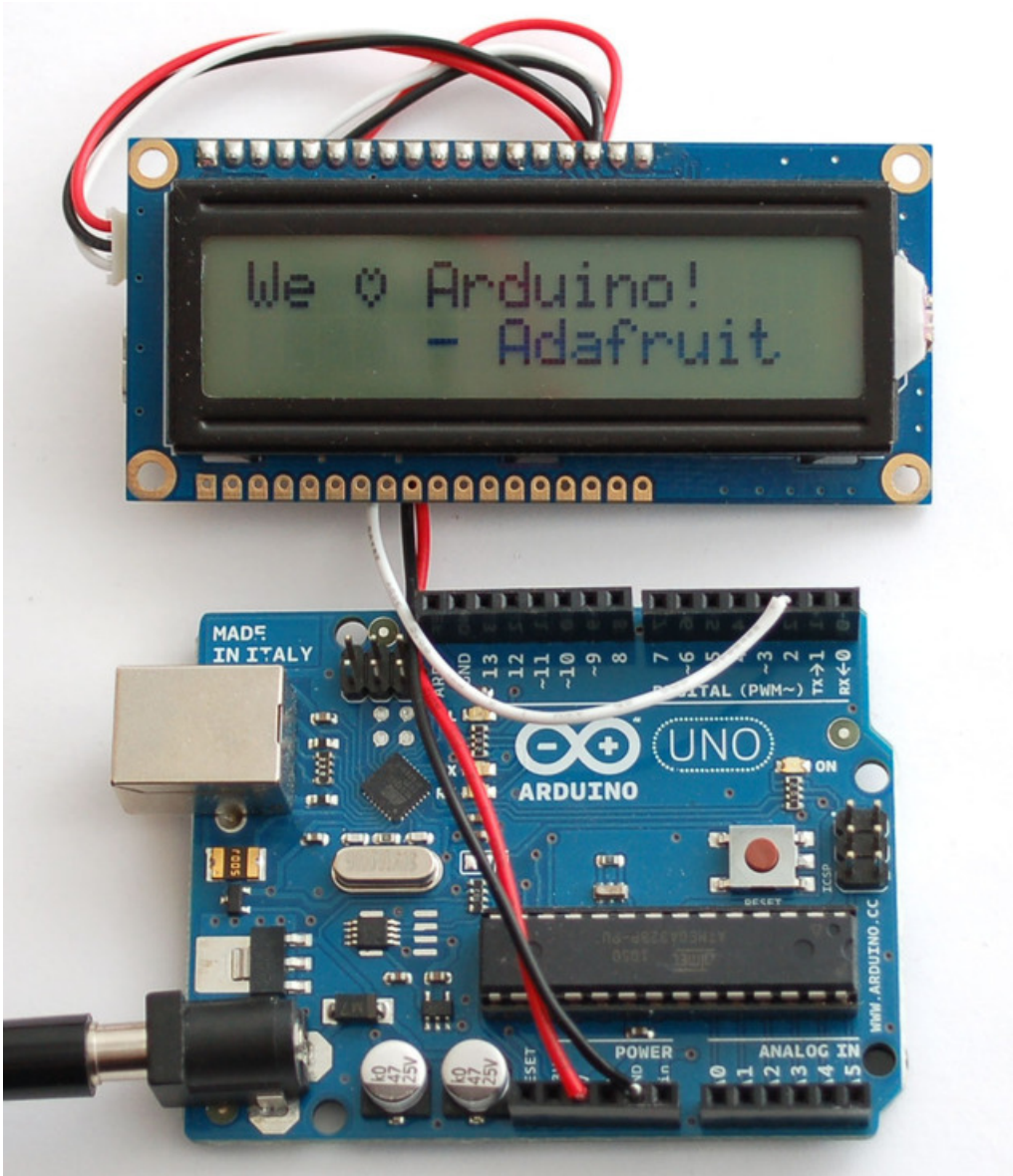

Command Reference

The command set is based on the Matrix Orbital specification. We added a few commands to support the RGB backlight and to adjust the size of the display (so one firmware can support 16x2 or 20x4) If you're using software that support Matrix Orbital displays, this backpack should work identically (if not, please let us know!)

All commands start with the special character **0xFE** (in hex) which tells the backpack to watch for a special command next.

Basic commands:

- **Display On - 0xFE 0x42** - This command turns the display backlight on . The argument is how many minutes to stay on, the command is supported but we don't handle the timeout so that number is ignored
- **Display On - 0xFE 0x46** - turn the display backlight off
- **Set Brightness - 0xFE 0x99** - set the overall brightness of the backlight (the color component is set separately - brightness setting takes effect after the color is set). Setting is saved to EEPROM
- **Set & Save Brightness - 0xFE 0x98** - same as above
- **Set Contrast - 0xFE 0x50** - set the display contrast. In general, around 180-220 value is what works well. Setting is saved to EEPROM
- **Set & Save Contrast - 0xFE 0x91** - same as above
- **Autoscroll on - 0xFE 0x51** - this will make it so when text is received and there's no more space on the display, the text will automatically 'scroll' so the second line becomes the first line, etc. and new text is always at the bottom of the display
- **Autoscroll off - 0xFE 0x52** - this will make it so when text is received and there's no more space on the display, the text will wrap around to start at the top of the display.
- **Clear screen - 0xFE 0x58** - this will clear the screen of any text
- **Change startup splash screen - 0xFE 0x40** - after sending this command, write up to 32 characters (for 16x2) or up to 80 characters (for 20x4) that will appear as the splash screen during startup. If you don't want a splash screen, write a bunch of spaces
- **Moving and changing the cursor:**
- **Set cursor position - 0xFE 0x47** - set the position of text entry cursor. Column and row numbering starts with 1 so the first position in the very top left is (1, 1)
- **Go home - 0xFE 0x48** - place the cursor at location (1, 1)
- **Cursor back - 0xFE 0x4C** - move cursor back one space, if at location (1,1) it will 'wrap' to the last position.
- **Cursor forward - 0xFE 0x4D** - move cursor back one space, if at the last location location it will 'wrap' to the (1,1) position.
- **Underline cursor on - 0xFE 0x4A** - turn on the underline cursor
- **Underline cursor off - 0xFE 0x4B** - turn off the underline cursor
- **Block cursor on - 0xFE 0x53** - turn on the blinking block cursor
- **Block cursor off - 0xFE 0x54** - turn off the blinking block cursor

RGB Backlight and LCD size

- **Set RGB Backlight Color - 0xFE 0xD0** - Sets the backlight to the red, green and blue component colors. The values of can range from 0 to 255 (one byte). This is saved to EEPROM. Each color R, G, and B is represented by a byte following the command. Color values range from 0 to 255 (0xFF in hex). To set the backlight to Red, the command is **0xFE 0xD0 0xFF 0x0 0x0**. Blue is **0xFE 0xD0 0x0 0x0 0xFF**. White is **0xFE 0xD0 0xFF 0xFF 0xFF**.
- **Set LCD size - 0xFE 0xD1** - You can configure the backpack to what size display is attached. This is saved to

EEPROM so you only have to do it once. Custom Characters

- **Create custom character - 0xFE 0x4E** - this will create a custom character in spot . can be between 0 and 7 (8 spots). 8 bytes are sent which indicate how the character should appear
- **Save custom character to EEPROM bank - 0xFE 0xC1** - this will save the custom character to EEPROM bank for later use. There are 4 banks and 8 locations per bank.
- **Load custom characters from EEPROM bank - 0xFE 0xC0** - this will load all 8 characters saved to an EEPROM bank into the LCD's memory

The general purpose outputs are 4 pins that are not used by the backpack, you can set these pins high or low. **GPO1** is labeled PB0, **GPO2** is labeled PC2, **GPO3** is labeled PC4 and **GPO4** is PC7

- **GPO Off - 0xFE 0x56** - set the general purpose pin to LOW (0V)
- **GPO On - 0xFE 0x57** - set the general purpose pin to HIGH (5V)
- **GPO Start State - 0xFE 0xC3** - sets the 'initial' state of the GPO pin Not handled!
- **Set auto-line-wrap on - 0xFE 0x43-** and **Set auto-line-wrap off - 0xFE 0x44-** are not supported. We found that having auto-line wrap off was just not very useful so its automatically on all the time.
- **Initialize/Place Medium & Large Numbers, Horizontal bar and vertical bar** -this is not supported

Downloads

Files

- [Testing software \(https://adafru.it/aXM\)](https://adafru.it/aXM) and [AT90 Firmware \(https://adafru.it/aXM\)](https://adafru.it/aXM) @ github. The backpack uses the Teensy v1.0 framework, we don't have tutorials or support for modifying the firmware but it is available for your hacking pleasure should you want to customize the backpack firmware! We also broke out the unused At90USB162 pins into an extra header - see the schematic for the unused/used pins. You can launch the bootloader (AT90USB162 chip) by touching reset pin to ground. It is an av109-compatible bootloader over USB, avrdude supports it but we don't have arduino IDE support at this time (and no ETA)
- [EagleCAD PCB Files on GitHub \(https://adafru.it/rVC\)](https://adafru.it/rVC)
- [LCD Smartie \(https://adafru.it/aXN\)](https://adafru.it/aXN) - a popular character LCD driving program
- [Fritzing object in the Adafruit Fritzing Library \(https://adafru.it/aP3\)](https://adafru.it/aP3)

Drivers

Here's INF driver for windows XP/7/Vista. Unzip and navigate to the folder in the New Hardware Wizard. Click here:

<https://adafru.it/d4R>

<https://adafru.it/d4R>

We also have Windows 8 signed drivers - they're beta so please try!

<https://adafru.it/Ccb>

<https://adafru.it/Ccb>

Schematic & Fabrication Print

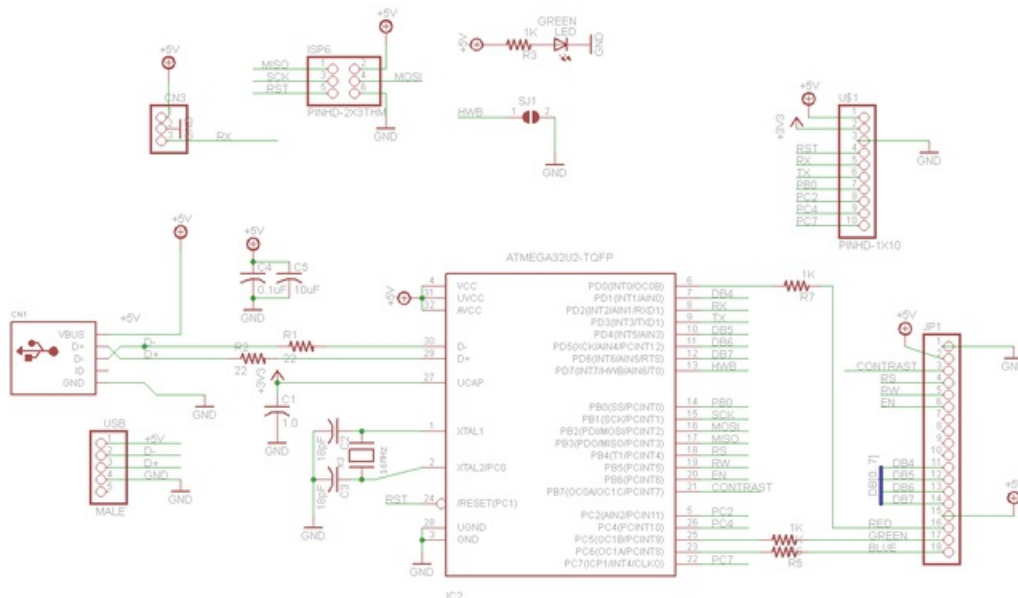

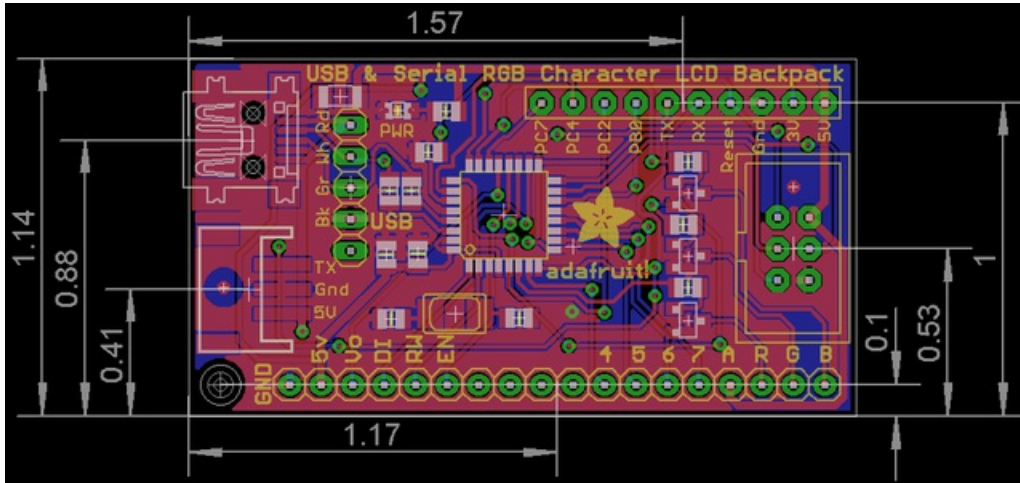

Компания «Life Electronics» занимается поставками электронных компонентов импортного и отечественного производства от производителей и со складов крупных дистрибьюторов Европы, Америки и Азии.

С конца 2013 года компания активно расширяет линейку поставок компонентов по направлению коаксиальный кабель, кварцевые генераторы и конденсаторы (керамические, пленочные, электролитические), за счёт заключения дистрибьюторских договоров

Мы предлагаем:

- Конкурентоспособные цены и скидки постоянным клиентам.
- Специальные условия для постоянных клиентов.
- Подбор аналогов.
- Поставку компонентов в любых объемах, удовлетворяющих вашим потребностям.
- Приемлемые сроки поставки, возможна ускоренная поставка.
- Доставку товара в любую точку России и стран СНГ.
- Комплексную поставку.
- Работу по проектам и поставку образцов.
- Формирование склада под заказчика.
- Сертификаты соответствия на поставляемую продукцию (по желанию клиента).
- Тестирование поставляемой продукции.
- Поставку компонентов, требующих военную и космическую приемку.
- Входной контроль качества.
- Наличие сертификата ISO.

В составе нашей компании организован Конструкторский отдел, призванный помогать разработчикам, и инженерам.

Конструкторский отдел помогает осуществить:

- Регистрацию проекта у производителя компонентов.
- Техническую поддержку проекта.
- Защиту от снятия компонента с производства.
- Оценку стоимости проекта по компонентам.
- Изготовление тестовой платы монтаж и пусконаладочные работы.



Тел: +7 (812) 336 43 04 (многоканальный)

Email: org@lifeelectronics.ru