

THIS DRAWING IS UNPUBLISHED. RELEASED FOR PUBLICATION
 © COPYRIGHT - By - ALL RIGHTS RESERVED.

LOC	DIST	REVISIONS					
		P	LTR	DESCRIPTION	DATE	DWN	APVD
			D9	REVISED PER ECO-12-012202	03JUL12	KH	MS

PHYSICAL PROPERTIES:
 HOUSING MATERIAL: PBT
 FLAMMABILITY: UL94V-0
 COLOR: BLACK

TERMINAL:
 TERMINALS: BRASS, TIN PLATED
 SCREWS: 6-32, STEEL, NICKEL PLATED

MECHANICAL:
 PITCH (TERMINAL SPACING): 9.50mm (.374")
 WIRE RANGE: 12-22 AWG
 RECOMMENDED TIGHTENING TORQUE: 12IN-LBS MAX.

ELECTRICAL PROPERTIES:
 MAXIMUM CURRENT: 20A
 OPERATING VOLTAGE: 300V

ENVIRONMENTAL PROPERTIES:
 OPERATING TEMP RANGE: -40°C TO 120°C

- 1 SCREWS ON ONE SIDE IN WIRE READY POSITION.
- 2 SEE FIGURE.
- 3 WHITE INK STAMP.
- 4 NICKEL PLATED BRASS SCREWS.
- 5 PRELIMINARY PART NUMBER.
- 6 TE CONNECTIVITY LOGO LOCATED APPROXIMATE AREA SHOWN.

LOC	DIST	P	LTR	DESCRIPTION	DATE	DWN	APVD
5/2				104.7 112.2 - - 10 4-1546307-7			
5/2				104.7 112.2 - - 10 4-1546307-6			
5/4				104.7 112.2 - - 10 4-1546307-5			
5/2/1				104.7 112.2 - - 10 3-1546307-3			
5/2/1				104.7 112.2 - - 10 1-1546307-0			
5/3/2/1				95.2 102.7 - 9 9 5-1546307-0			
5/3/2/1				95.2 102.7 4 9 9 4-1546307-9			
3/2/1				95.2 102.7 4 9 9 4-1546307-8			
				95.2 102.7 - - 9 1546307-9			
				85.7 93.2 - - 8 1546307-8			
				76.2 83.7 - - 7 1546307-7			
5/4				66.7 74.2 - - 6 4-1546307-4			
5/4				66.7 74.2 - - 6 1546307-6			
5/2				57.2 64.7 - - 5 4-1546307-3			
5/2				57.2 64.7 - - 5 4-1546307-2			
5/2				57.2 64.7 - - 5 4-1546307-1			
5/2				57.2 64.7 - - 5 4-1546307-0			
5/4				57.2 64.7 - - 5 3-1546307-9			
				57.2 64.7 - - 5 1546307-5			
5/2/1				47.7 55.2 - - 4 3-1546307-2			
				47.7 55.2 - - 4 1546307-4			
5/2				38.2 45.7 - - 3 3-1546307-8			
5/2				38.2 45.7 - - 3 3-1546307-7			
5/2				38.2 45.7 - - 3 3-1546307-6			
5/2				38.2 45.7 - - 3 3-1546307-5			
5/4				38.2 45.7 - - 3 3-1546307-4			
				38.2 45.7 - - 3 1546307-3			
				28.7 36.2 - - 2 1546307-2			
	DIM B	DIM A	QC TAB .187 45° ②	QC TAB .187 FLAT ①	NO OF POSN	PART NUMBER	

THIS DRAWING IS A CONTROLLED DOCUMENT.		DWN S SCHLEGEL 20AUG2002	 TE Connectivity					
DIMENSIONS: mm		CHK C RICHARD 8/20/02						
TOLERANCES UNLESS OTHERWISE SPECIFIED:		APVD C RICHARD 8/20/02	NAME 9.50MM (.374) DBL ROW BARRIER STRIP W/ WASHER					
0 PLC ± -		PRODUCT SPEC	APPLICATION SPEC					
1 PLC ± 0.3		SIZE				CAGE CODE	DRAWING NO	RESTRICTED TO
2 PLC ± 0.25		A3				00779	C-1546307	
3 PLC ± -		CUSTOMER DRAWING				SCALE	1:1	SHEET
4 PLC ± -		MATERIAL						1 OF 3
FINISH		WEIGHT						REV
MATERIAL		D9						

THIS DRAWING IS UNPUBLISHED. RELEASED FOR PUBLICATION
 © COPYRIGHT - By - ALL RIGHTS RESERVED.

LOC	DIST	REVISIONS					
		P	LTR	DESCRIPTION	DATE	DWN	APVD
-	-	-	-	SEE SHEET 1	-	-	-



3-1546307-1



3-1546307-5



3-1546307-2

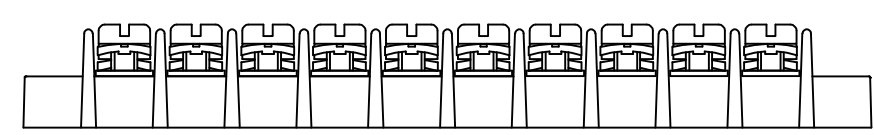
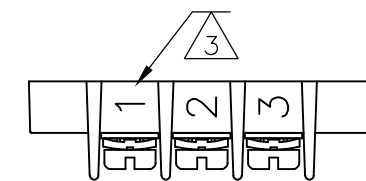
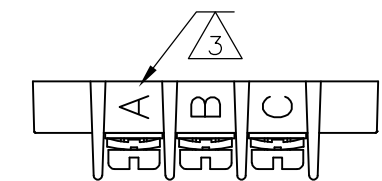

3-1546307-3



3-1546307-7



3-1546307-8



3-1546307-6

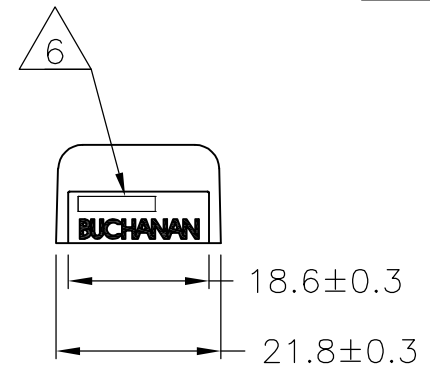

294.7	302.2	-	-	30	3-1546307-0
285.2	292.7	-	-	29	2-1546307-9
275.7	283.2	-	-	28	2-1546307-8
266.2	273.7	-	-	27	2-1546307-7
256.7	264.2	-	-	26	2-1546307-6
247.2	254.7	-	-	25	2-1546307-5
237.7	245.2	-	-	24	2-1546307-4
228.2	235.7	-	-	23	2-1546307-3
218.7	226.2	-	-	22	2-1546307-2
209.2	216.7	-	-	21	2-1546307-1
199.7	207.2	-	-	20	3-1546307-1
199.7	207.2	-	-	20	2-1546307-0
190.2	197.7	-	-	19	1-1546307-9
180.7	188.2	-	-	18	1-1546307-8
171.2	178.7	-	-	17	1-1546307-7
161.7	169.2	-	-	16	1-1546307-6
152.2	159.7	-	-	15	1-1546307-5
142.7	150.2	-	-	14	1-1546307-4
133.2	140.7	-	-	13	1-1546307-3
123.7	131.2	-	-	12	1-1546307-2
114.2	121.7	-	-	11	1-1546307-1
DIM B	DIM A	QC TAB .187 45° ②	QC TAB .187 FLAT ①	NO OF POSN	PART NUMBER

THIS DRAWING IS A CONTROLLED DOCUMENT.

DIMENSIONS: mm

TOLERANCES UNLESS OTHERWISE SPECIFIED:

0 PLC	± -
1 PLC	± 0.3
2 PLC	± 0.25
3 PLC	± -
4 PLC	± -
ANGLES	± 2°

MATERIAL: - FINISH: -

DWN: S SCHLEGEL 20AUG2002
 CHK: C RICHARD 8/20/02
 APVD: C RICHARD 8/20/02

STE TE Connectivity

9.50MM (.374) DBL ROW BARRIER STRIP W/ WASHER

SIZE: A3 CAGE CODE: 00779 DRAWING NO: C-1546307 RESTRICTED TO: -

CUSTOMER DRAWING SCALE: 1:1 SHEET: 2 OF 3 REV: D9

THIS DRAWING IS UNPUBLISHED.

RELEASED FOR PUBLICATION

ALL RIGHTS RESERVED.

© COPYRIGHT - By -

LOC - -

DIST - -

REVISIONS

P LTR

DESCRIPTION

DATE

DWN

APVD

SEE SHEET 1

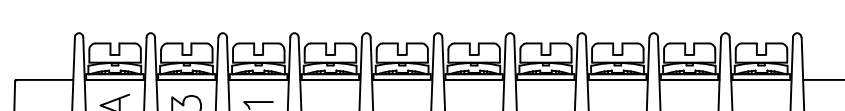
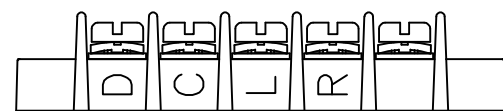
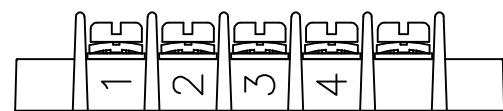
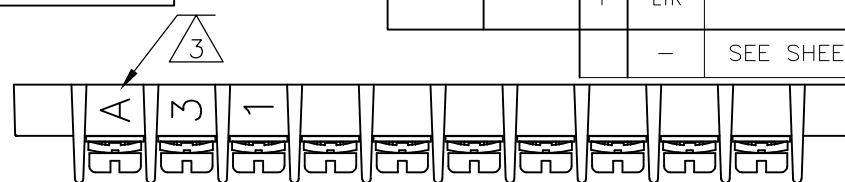
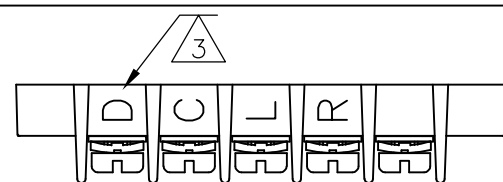
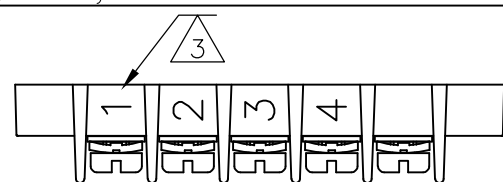

4-1546307-2

4-1546307-3

4-1546307-7

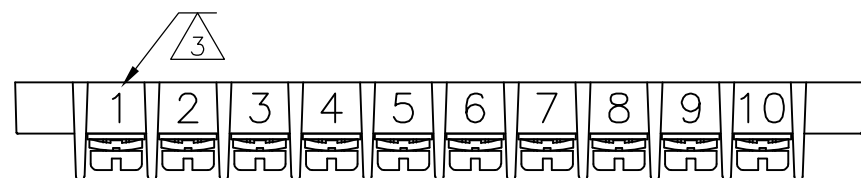

4-1546307-6

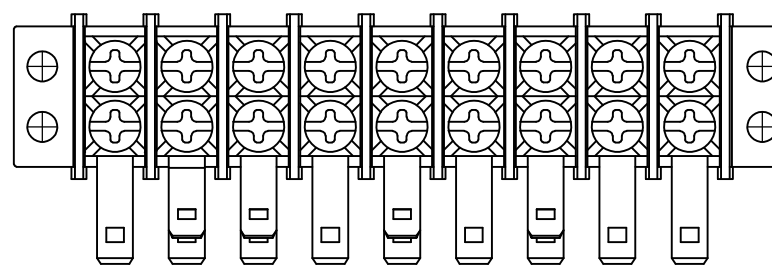

4-1546307-8

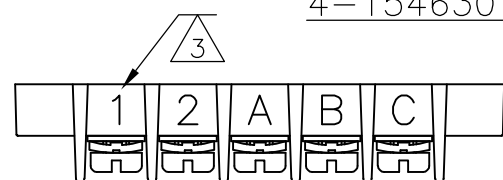

4-1546307-0

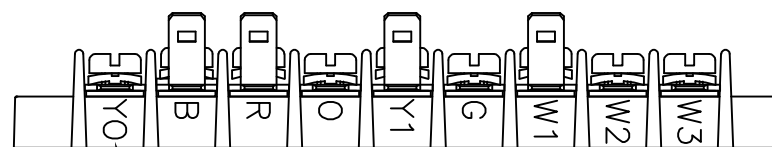

MARK BOTH SIDES

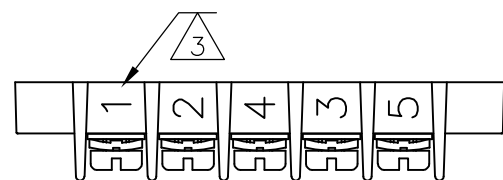

4-1546307-1

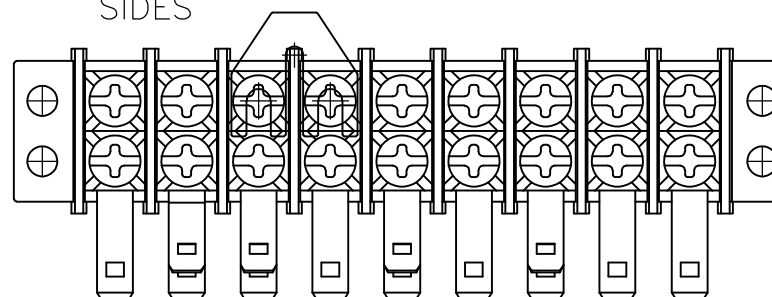

MARK BOTH SIDES

4-1546307-9

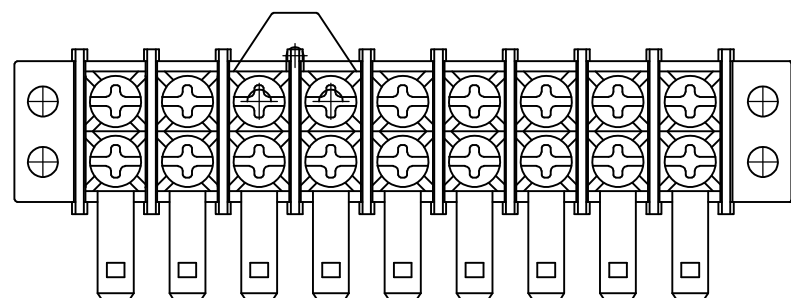

5-1546307-0

MARK BOTH SIDES

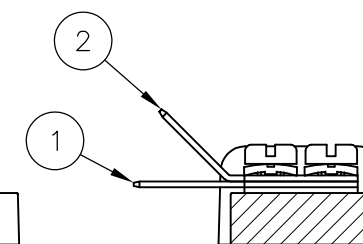
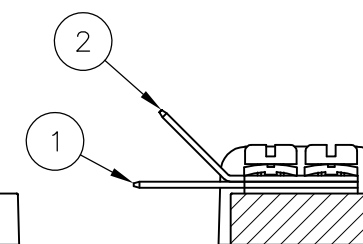
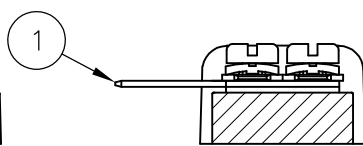

THIS DRAWING IS A CONTROLLED DOCUMENT.

DWN 20AUG2002

S SCHLEGEL

CHK 8/20/02

C RICHARD

APVD 8/20/02

C RICHARD

PRODUCT SPEC

APPLICATION SPEC

WEIGHT -

CUSTOMER DRAWING

STE TE Connectivity

9.50MM (.374) DBL ROW BARRIER STRIP W/ WASHER

SIZE A3 CAGE CODE 00779 DRAWING NO C-1546307 RESTRICTED TO -

SCALE 1:1 SHEET 3 OF 3 REV D9

DIMENSIONS:

mm

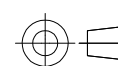

TOLERANCES UNLESS OTHERWISE SPECIFIED:

- 0 PLC ± -
- 1 PLC ± 0.3
- 2 PLC ± 0.25
- 3 PLC ± -
- 4 PLC ± -
- ANGLES ± 2'
- FINISH -

MATERIAL -

Компания «Life Electronics» занимается поставками электронных компонентов импортного и отечественного производства от производителей и со складов крупных дистрибьюторов Европы, Америки и Азии.

С конца 2013 года компания активно расширяет линейку поставок компонентов по направлению коаксиальный кабель, кварцевые генераторы и конденсаторы (керамические, пленочные, электролитические), за счёт заключения дистрибьюторских договоров

Мы предлагаем:

- Конкурентоспособные цены и скидки постоянным клиентам.
- Специальные условия для постоянных клиентов.
- Подбор аналогов.
- Поставку компонентов в любых объемах, удовлетворяющих вашим потребностям.
- Приемлемые сроки поставки, возможна ускоренная поставка.
- Доставку товара в любую точку России и стран СНГ.
- Комплексную поставку.
- Работу по проектам и поставку образцов.
- Формирование склада под заказчика.
- Сертификаты соответствия на поставляемую продукцию (по желанию клиента).
- Тестирование поставляемой продукции.
- Поставку компонентов, требующих военную и космическую приемку.
- Входной контроль качества.
- Наличие сертификата ISO.

В составе нашей компании организован Конструкторский отдел, призванный помогать разработчикам, и инженерам.

Конструкторский отдел помогает осуществить:

- Регистрацию проекта у производителя компонентов.
- Техническую поддержку проекта.
- Защиту от снятия компонента с производства.
- Оценку стоимости проекта по компонентам.
- Изготовление тестовой платы монтаж и пусконаладочные работы.



Тел: +7 (812) 336 43 04 (многоканальный)

Email: org@lifeelectronics.ru