



## Features

- Conductive plastic
- PC board and bushing mount
- Plastic or metal bushing and plastic shaft
- Withstands typical industrial washing processes
- Compact package saves board and panel space



# 3310 - 9 mm Square Sealed Panel Control

### Electrical Characteristics

Standard Resistance Range - Linear .....	1 K ohms to 1 megohm
Total Resistance Tolerance - Linear Tapers .....	±20 %
Independent Linearity .....	±5 %
Absolute Minimum Resistance .....	2 ohms maximum
Effective Electrical Angle .....	270 ° ±15 °
Contact Resistance Variation .....	1 % or 1 ohm (whichever is greater)
Dielectric Withstanding Voltage (MIL-STD-202 – Method 301)	
Sea Level .....	900 VAC minimum
70,000 Feet .....	350 VAC minimum
Insulation Resistance .....	1,000 megohms minimum
Power Rating @ 70 °C (Derate to 0 at 125 °C - Voltage Limited By Power Dissipation or 200 VAC, Whichever is Less) .....	0.25 watts
Theoretical Resolution .....	Essentially infinite

### Environmental Characteristics

Operating Temperature Range .....	-40 °C to +125 °C (-40 °F to +257 °F)
Storage Temperature Range .....	-55 °C to +125 °C (-67 °F to +257 °F)
Temperature Coefficient Over Storage Temperature Range .....	±1,000 ppm/°C
Vibration .....	30 G
Total Resistance Shift .....	±1 % maximum
Voltage Ratio Shift .....	±1 % maximum
Shock .....	100 G
Total Resistance Shift .....	±1 % maximum
Voltage Ratio Shift .....	±1 % maximum
Load Life .....	1,000 hours
Total Resistance Shift .....	±10 % TRS maximum
Rotational Life (No Load) .....	50,000 cycles
Total Resistance Shift .....	±5 % TRS maximum
Contact Resistance Variation .....	3 % or 3 ohms, whichever is greater
Moisture Resistance .....	MIL-STD-202, Method 103, Condition B
Total Resistance Shift .....	±10 % TRS maximum
IP Rating .....	IP67

### Mechanical Characteristics

Stop Strength .....	5.65 N-cm (8 oz.-in.)
Mechanical Angle .....	300 ° nominal
Torque	
Starting .....	3.53 N-cm (5.0 oz.-in.) maximum
Running .....	3.53 N-cm (5.0 oz.-in.) maximum
Mounting (Torque on Bushing) .....	45 N-cm (4.0 lb.-in.) max [plastic bushing]; 79 N-cm (7.0 lb.-in.) max [metal bushing]
Weight (Single Section) .....	4.5 grams
(Each Additional Section) .....	2.5 grams
Terminals .....	Solderable pins
Soldering Condition	
Manual Soldering .....	96.5Sn/3.0Ag/0.5Cu solid wire or no-clean rosin cored wire; 370 °C (700 °F) max. for 3 seconds
Wave Soldering .....	96.5Sn/3.0Ag/0.5Cu solder with no-clean flux; 260 °C (500 °F) max. for 5 seconds
Wash Processes .....	For recommended wash processes, please refer to <a href="http://www.bourns.com/pdfs/sldclen.pdf">http://www.bourns.com/pdfs/sldclen.pdf</a>
Marking .....	Manufacturer's trademark, model number, product code, terminal style, resistance code and date code
Ganging .....	2 cups maximum
Hardware .....	One lockwasher and one mounting nut is shipped with each potentiometer, except where noted in the part number.
Flammability .....	Conforms to UL94V-0
Epoxy .....	Conforms to UL 94V-1
IP Rating .....	IP67

### Switch Characteristics

Switch Life .....	10K cycles
Contact Resistance .....	2 ohms max.
Dielectric Strength .....	350 VDC
Detent Torque .....	0.5 oz-in min.
Power Rating (Resistive Load) .....	100 mA @ 16 VDC

\*RoHS Directive 2002/95/EC Jan. 27, 2003 including annex and RoHS Recast 2011/65/EU June 8, 2011.  
 Specifications are subject to change without notice.  
 Customers should verify actual device performance in their specific applications.

## Additional Features

- Audio taper versions available as special order
- RoHS compliant\*

# 3310 - 9 mm Square Sealed Panel Control

**BOURNS®**

### Standard Resistance Table

Resistance (Ohms)	Resistance Code
<b>1,000</b>	<b>102</b>
<b>2,000</b>	<b>202</b>
<b>5,000</b>	<b>502</b>
<b>10,000</b>	<b>103</b>
<b>20,000</b>	<b>203</b>
50,000	503
100,000	104
200,000	204
500,000	504
1,000,000	105

Popular values listed in boldface. Consult factory for special resistances.

### How To Order

**3310 Y - 0 0 1 - 103 L**

Model Number Designator \_\_\_\_\_  
 3310 = 9 mm Panel Control

Terminal Style Designator \_\_\_\_\_  
 Single Cup:  
 C = In-line Straight Terminals Side Exit 2.54 mm centers  
 R = In-line Terminals Rear Exit 2.54 mm centers  
 P = 5.08 mm x 2.54 mm Triangular Pattern Rear Exit  
 Y = 5.08 mm x 5.08 mm Triangular Pattern Rear Exit

Dual Cup (Pot/Pot or Pot/Switch):  
 H = Dual In-line Straight Terminals Rear Exit 2.54 mm centers

Shaft End Designator \_\_\_\_\_  
 0 = Shaft End Slotted  
 1 = Shaft End Flatted

Shaft Length Designator \_\_\_\_\_  
 0 = 12.7 mm FMS Long Plastic Shaft (Available w/bushing only)  
 1 = 19.05 mm FMS Long Plastic Shaft (Available w/bushing only)  
 2 = 5.59 mm FMS Long Plastic Shaft (Bushingless version only)

Bushing Designator \_\_\_\_\_  
 Pot (or Pot/Pot):  
 1 = 6.35 mm x 6.35 mm Plastic  
 2 = 6.35 mm x 6.35 mm Ni Plated Brass  
 5 = Bushingless (Board Level Control)

Pot/Switch Bushing Designator (use with "H" terminal style only.)  
 3 = 6.35 mm x 6.35 mm Plastic  
 4 = 6.35 mm x 6.35 mm Ni Plated Brass  
 6 = Bushingless (Board Level)

Resistance Code \_\_\_\_\_  
 (1st 2 digits are significant, 3rd digit is number of 0s to follow)

RoHS Identifier \_\_\_\_\_  
 L = Compliant

# 3310 - 9 mm Square Sealed Panel Control

**BOURNS®**

## Product Dimensions

### COMMON DIMENSIONS 3310-001

Plastic Bushing  
Slotted Shaft

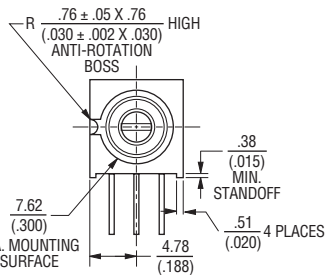

### MOUNTING HOLE PATTERN



### 3310C-001



### 3310P-001



### 3310R-001

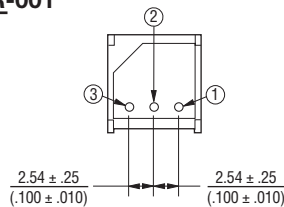

DIMENSIONS:  $\frac{\text{MM}}{\text{(INCHES)}}$

### 3310Y-001

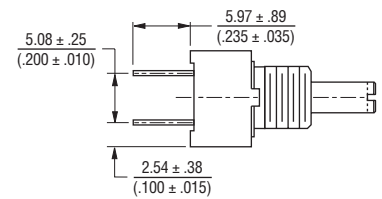

### COMMON DIMENSIONS 3310C-101

Plastic Flatted Shaft

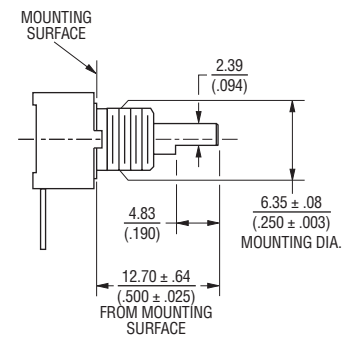

The shaft flat position as shown above is at 50 % of the mechanical travel.

# 3310 - 9 mm Square Sealed Panel Control

**BOURNS®**

## Product Dimensions

### COMMON DIMENSIONS 3310-002 Metal Bushing



### 3310P-025\* Bushingsless



### 3310C-002



DIMENSIONS:  $\frac{\text{MM}}{\text{(INCHES)}}$

NOTE: \* Only recommended shaft length for bushingsless version

# 3310 - 9 mm Square Sealed Panel Control

# BOURNS®

## Product Dimensions

**COMMON DIMENSIONS**  
**3310H-003**  
 Pot/Switch Dual Cup  
 Plastic Bushing

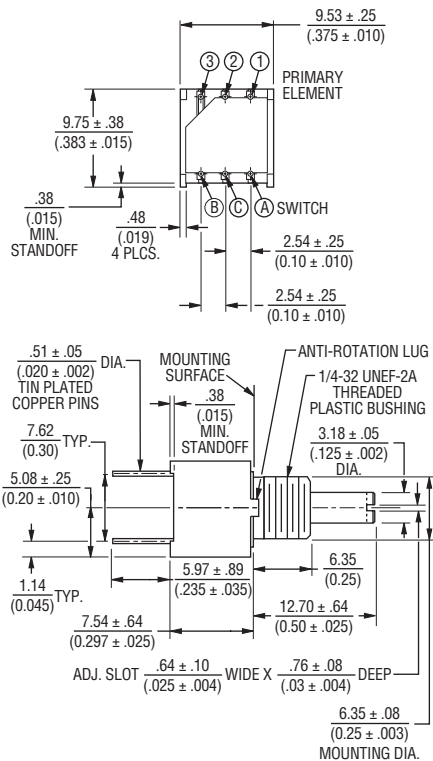

**3310H-025\***  
 Pot/Pot Dual Cup  
 Bushingless

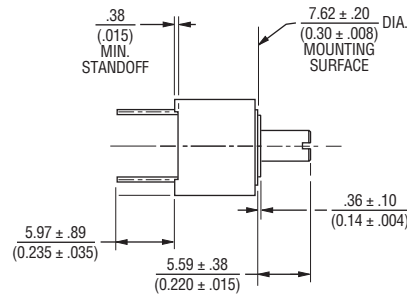
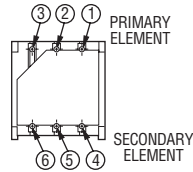

Pot/Pot Dual Cup

**3310H-002**  
 Pot/Pot Dual Cup  
 Metal Bushing

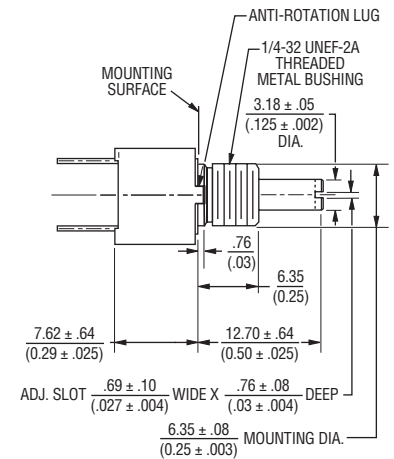
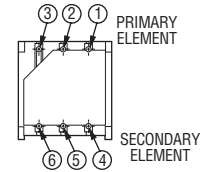

Pot/Switch Dual Cup

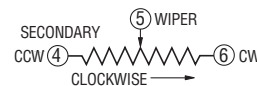
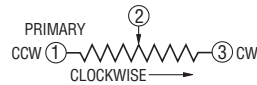

DIMENSIONS:  $\frac{\text{MM}}{\text{(INCHES)}}$

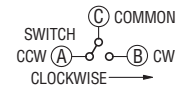
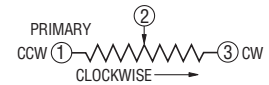

Pot Single Cup

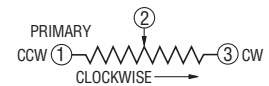

NOTE: \* Only recommended shaft length for bushingless version

REV. 08/12

Specifications are subject to change without notice. Customers should verify actual device performance in their specific applications.

Компания «Life Electronics» занимается поставками электронных компонентов импортного и отечественного производства от производителей и со складов крупных дистрибьюторов Европы, Америки и Азии.

С конца 2013 года компания активно расширяет линейку поставок компонентов по направлению коаксиальный кабель, кварцевые генераторы и конденсаторы (керамические, пленочные, электролитические), за счёт заключения дистрибьюторских договоров

Мы предлагаем:

- Конкурентоспособные цены и скидки постоянным клиентам.
- Специальные условия для постоянных клиентов.
- Подбор аналогов.
- Поставку компонентов в любых объемах, удовлетворяющих вашим потребностям.
- Приемлемые сроки поставки, возможна ускоренная поставка.
- Доставку товара в любую точку России и стран СНГ.
- Комплексную поставку.
- Работу по проектам и поставку образцов.
- Формирование склада под заказчика.
- Сертификаты соответствия на поставляемую продукцию (по желанию клиента).
- Тестирование поставляемой продукции.
- Поставку компонентов, требующих военную и космическую приемку.
- Входной контроль качества.
- Наличие сертификата ISO.

В составе нашей компании организован Конструкторский отдел, призванный помогать разработчикам, и инженерам.

Конструкторский отдел помогает осуществить:

- Регистрацию проекта у производителя компонентов.
- Техническую поддержку проекта.
- Защиту от снятия компонента с производства.
- Оценку стоимости проекта по компонентам.
- Изготовление тестовой платы монтаж и пусконаладочные работы.



Тел: +7 (812) 336 43 04 (многоканальный)  
Email: [org@lifeelectronics.ru](mailto:org@lifeelectronics.ru)