

## 365nm UV LED Gen 2 Emitter

# LZ4-04UV00

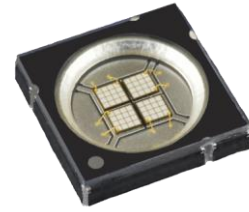

### Key Features

- High flux density 365nm surface mount ceramic package UV LED with integrated flat glass lens
- 2.2 mm x 2.2 mm Light Emitting Surface (LES) in a 7.0mm x 7.0mm emitter footprint
- Ideal for imaging optics with beam angles as narrow as  $\pm 3^\circ$
- Very low Thermal Resistance (1.1°C/W)
- Electrically neutral thermal path
- JEDEC Level 1 for Moisture Sensitivity Level
- Lead (Pb) free and RoHS compliant
- Reflow solderable (up to 6 cycles)
- Emitter available on Star MCPCB (optional)

### Typical Applications

- Curing
- Printing
- PCB Exposure
- Sterilization
- Medical
- Currency Verification
- Fluorescence Microscopy
- Inspection of dyes, rodent and animal contamination
- Forensics

### Description

The LZ4-04UV00 UV LED emitter provides superior radiometric power in the wavelength range specifically required for applications like curing, printing, sterilization, currency verification, and various medical applications. With a 2.2mm x 2.2mm LES, this package provides exceptional optical power density. The flat glass lens facilitates the use of imaging optics to produce extreme narrow beam angle, as well as light pipes and other optics. The high quality materials used in the package are chosen to optimize light output, have excellent UV resistance, and minimize stresses which results in monumental reliability and radiant flux maintenance.

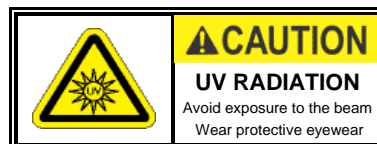

## Part number options

### Base part number

Part number	Description
LZ4-04UV00-xxxx	LZ4 emitter
LZ4-44UV00-xxxx	LZ4 emitter on Standard Star MCPCB

### Bin kit option codes

UV, Ultra-Violet (365nm)			
Kit number suffix	Min flux Bin	Color Bin Range	Description
0000	Q	U0	Q minimum flux; wavelength U0 bin only

## Radiant Flux Bins

Table 1:

Bin Code	Minimum Radiant Flux ( $\Phi$ ) @ $I_F = 700\text{mA}$ <sup>[1,2]</sup> (W)	Maximum Radiant Flux ( $\Phi$ ) @ $I_F = 700\text{mA}$ <sup>[1,2]</sup> (W)
Q	2.00	2.40
R	2.40	3.00
S	3.00	3.80

Notes for Table 1:

1. Radiant flux performance is measured at 10ms pulse,  $T_C = 25^\circ\text{C}$ . LED Engin maintains a tolerance of  $\pm 10\%$  on flux measurements.

## Peak Wavelength Bins

Table 2:

Bin Code	Minimum Peak Wavelength ( $\lambda_p$ ) @ $I_F = 700\text{mA}$ <sup>[1]</sup> (nm)	Maximum Peak Wavelength ( $\lambda_p$ ) @ $I_F = 700\text{mA}$ <sup>[1]</sup> (nm)
U0	365	370

Notes for Table 2:

1. Peak wavelength is measured at 10ms pulse,  $T_C = 25^\circ\text{C}$ . LED Engin maintains a tolerance of  $\pm 2.0\text{nm}$  on peak wavelength measurements.

## Forward Voltage Bins

Table 3:

Bin Code	Minimum Forward Voltage ( $V_F$ ) @ $I_F = 700\text{mA}$ <sup>[1]</sup> (V)	Maximum Forward Voltage ( $V_F$ ) @ $I_F = 700\text{mA}$ <sup>[1]</sup> (V)
0	14.0	18.0

Notes for Table 3:

1. Forward voltage is measured at 10ms pulse,  $T_C = 25^\circ\text{C}$ . LED Engin maintains a tolerance of  $\pm 0.04\text{V}$  for forward voltage measurements.

## Absolute Maximum Ratings

Table 4:

Parameter	Symbol	Value	Unit
DC Forward Current <sup>[1]</sup>	$I_F$	1000	mA
Peak Pulsed Forward Current <sup>[2]</sup>	$I_{FP}$	1000	mA
Reverse Voltage	$V_R$	See Note 3	V
Storage Temperature	$T_{stg}$	-40 ~ +150	°C
Junction Temperature	$T_J$	130	°C
Soldering Temperature <sup>[4]</sup>	$T_{sol}$	260	°C
Allowable Reflow Cycles		6	
ESD Sensitivity <sup>[5]</sup>		> 2,000 V HBM Class 2 JESD22-A114-D	

Notes for Table 4:

- Maximum DC forward current is determined by the overall thermal resistance and ambient temperature. Follow the curves in Figure 11 for current derating.
- Pulse forward current conditions: Pulse Width  $\leq$  10msec and Duty Cycle  $\leq$  10%.
- LEDs are not designed to be reverse biased.
- Solder conditions per JEDEC 020D. See Reflow Soldering Profile Figure 3.
- LED Engin recommends taking reasonable precautions towards possible ESD damages and handling the LZ4-04UV00 in an electrostatic protected area (EPA). An EPA may be adequately protected by ESD controls as outlined in ANSI/ESD S6.1.

## Optical Characteristics @ $T_C = 25^\circ\text{C}$

Table 5:

Parameter	Symbol	Typical	Unit
Radiant Flux (@ $I_F = 700\text{mA}$ )	$\Phi$	3.30	W
Radiant Flux (@ $I_F = 1000\text{mA}$ )	$\Phi$	4.60	W
Peak Wavelength <sup>[1]</sup>	$\lambda_p$	365	nm
Viewing Angle <sup>[2]</sup>	$2\Theta_{1/2}$	110	Degrees
Total Included Angle <sup>[3]</sup>	$\Theta_{0.9V}$	150	Degrees

Notes for Table 5:

- When operating the UV LED, observe IEC 60825-1 class 3B rating. Avoid exposure to the beam.
- Viewing Angle is the off axis angle from emitter centerline where the radiometric power is  $\frac{1}{2}$  of the peak value.
- Total Included Angle is the total angle that includes 90% of the total radiant flux.

## Electrical Characteristics @ $T_C = 25^\circ\text{C}$

Table 6:

Parameter	Symbol	Typical	Unit
Forward Voltage (@ $I_F = 700\text{mA}$ )	$V_F$	15.2	V
Temperature Coefficient of Forward Voltage	$\Delta V_F / \Delta T_J$	-5.2	mV/°C
Thermal Resistance (Junction to Case)	$R\Theta_{J-C}$	1.1	°C/W

## IPC/JEDEC Moisture Sensitivity Level

Table 7 - IPC/JEDEC J-STD-20D.1 MSL Classification:

Level	Soak Requirements					
	Floor Life		Standard		Accelerated	
	Time	Conditions	Time (hrs)	Conditions	Time (hrs)	Conditions
1	Unlimited	≤ 30°C/ 85% RH	168 +5/-0	85°C/ 85% RH	n/a	n/a

Notes for Table 7:

1. The standard soak time includes a default value of 24 hours for semiconductor manufacturer's exposure time (MET) between bake and bag and includes the maximum time allowed out of the bag at the distributor's facility.

## Mechanical Dimensions (mm)

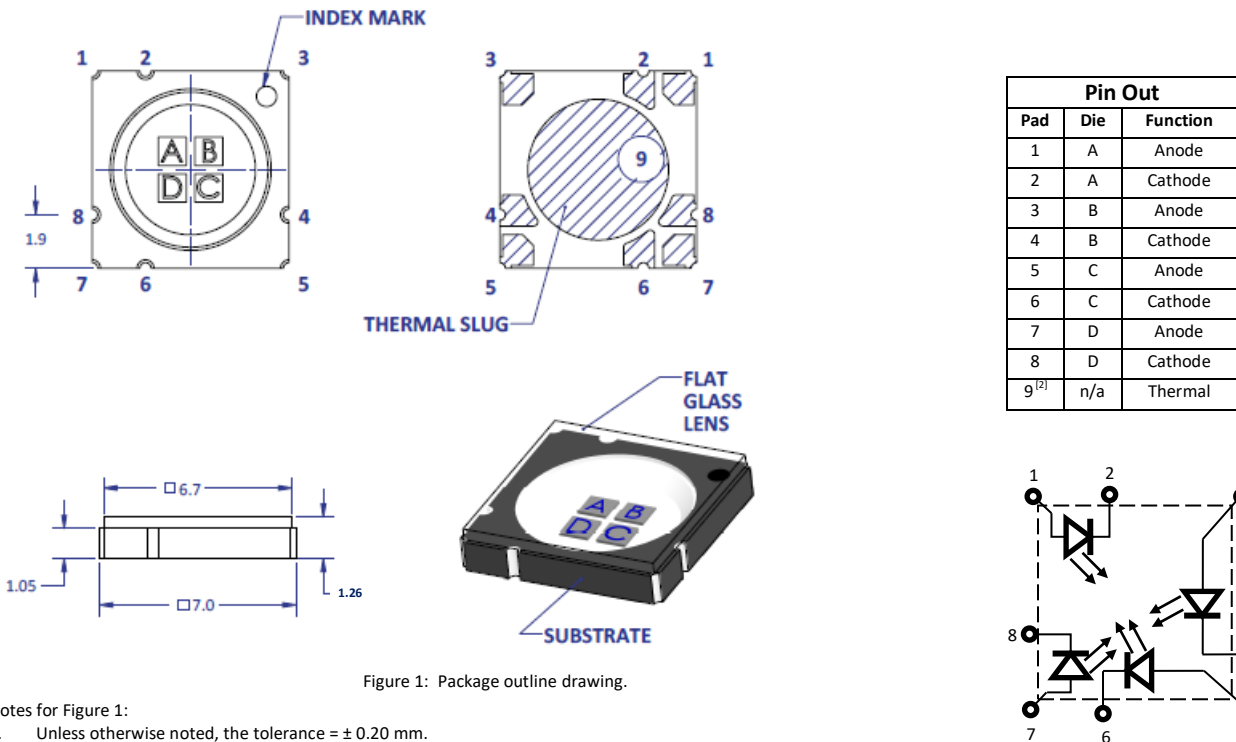

Figure 1: Package outline drawing.

Notes for Figure 1:

1. Unless otherwise noted, the tolerance =  $\pm 0.20$  mm.
2. Thermal contact, Pad 9, is electrically neutral.

## Recommended Solder Pad Layout (mm)

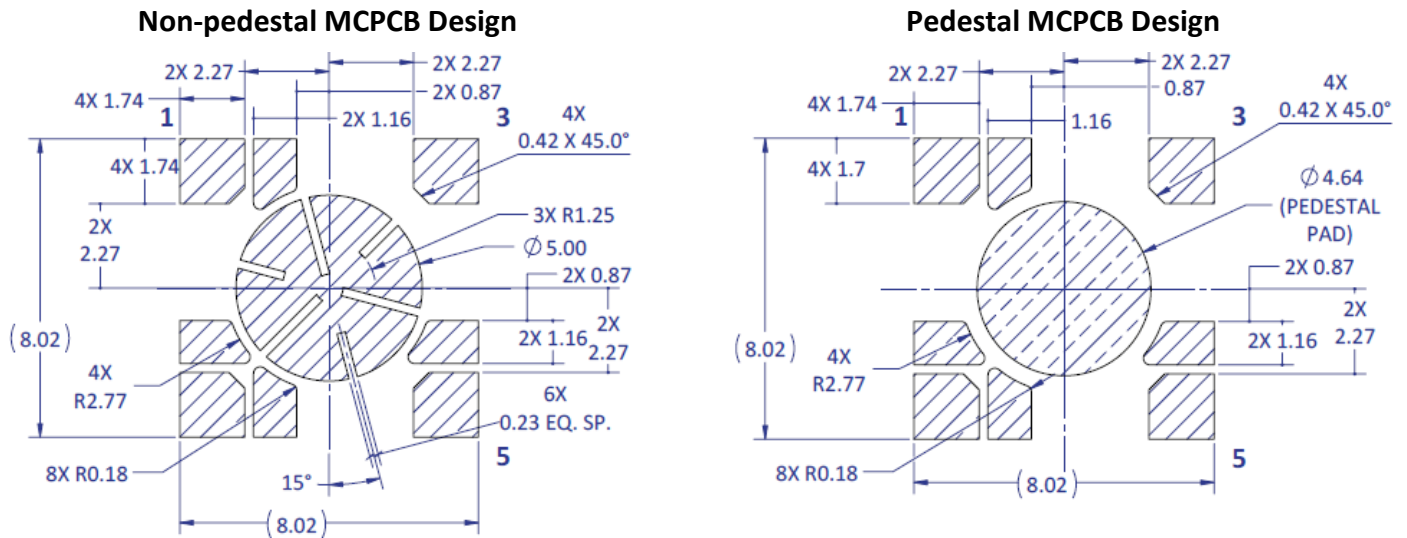

Figure 2a: Recommended solder pad layout for anode, cathode, and thermal pad for non-pedestal and pedestal design

Note for Figure 2a:

1. Unless otherwise noted, the tolerance =  $\pm 0.20$  mm.
2. Pedestal MCPCB allows the emitter thermal slug to be soldered directly to the metal core of the MCPCB. Such MCPCB eliminate the high thermal resistance dielectric layer that standard MCPCB technologies use in between the emitter thermal slug and the metal core of the MCPCB, thus lowering the overall system thermal resistance.
3. LED Engin recommends x-ray sample monitoring for solder voids underneath the emitter thermal slug. The total area covered by solder voids should be less than 20% of the total emitter thermal slug area. Excessive solder voids will increase the emitter to MCPCB thermal resistance and may lead to higher failure rates due to thermal over stress.
4. MCPCBs designed for other LZ4 emitters are compatible for this emitter.

## Recommended Solder Mask Layout (mm)

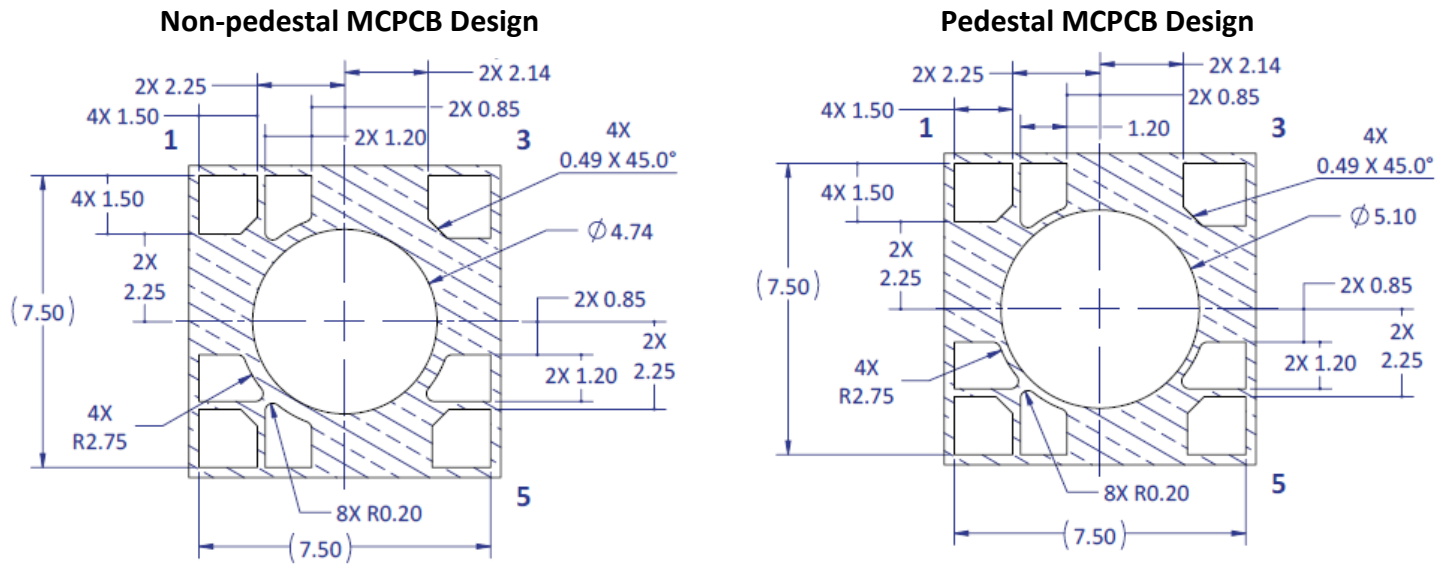

Figure 2b: Recommended solder mask opening for anode, cathode, and thermal pad for non-pedestal and pedestal design

Note for Figure 2b:

1. Unless otherwise noted, the tolerance =  $\pm 0.20$  mm.

## Recommended 8mil Stencil Apertures Layout (mm)

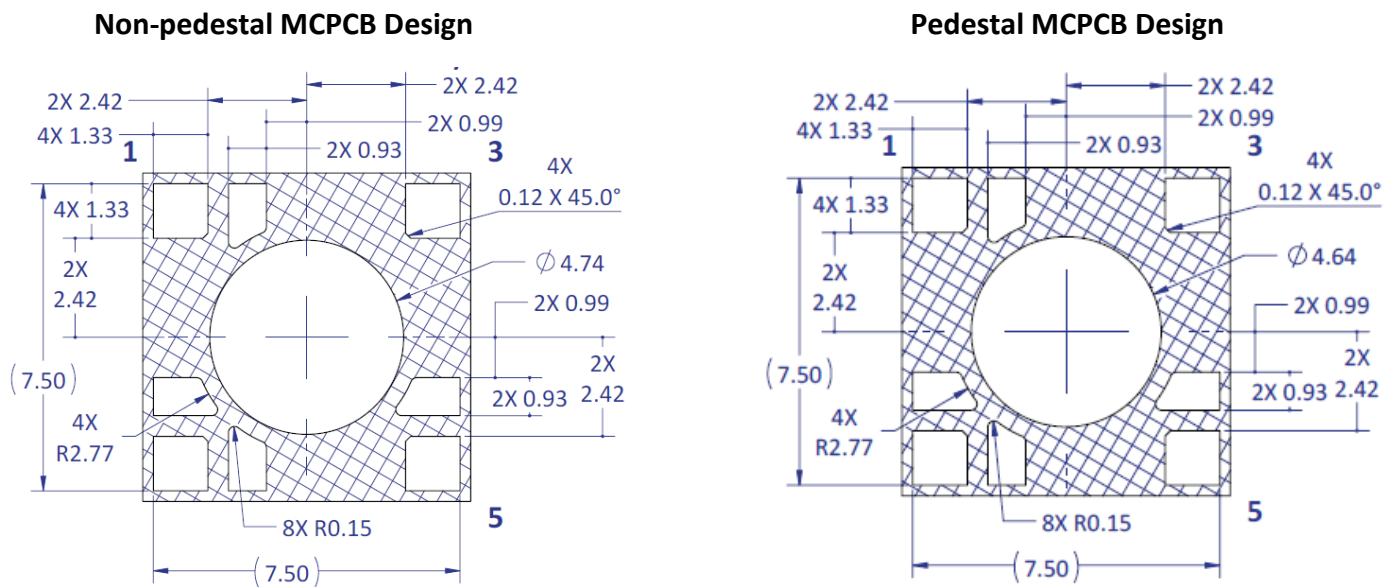

Figure 2c: Recommended solder mask opening for anode, cathode, and thermal pad for non-pedestal and pedestal design

Note for Figure 2c:

1. Unless otherwise noted, the tolerance =  $\pm 0.20$  mm.

## Reflow Soldering Profile

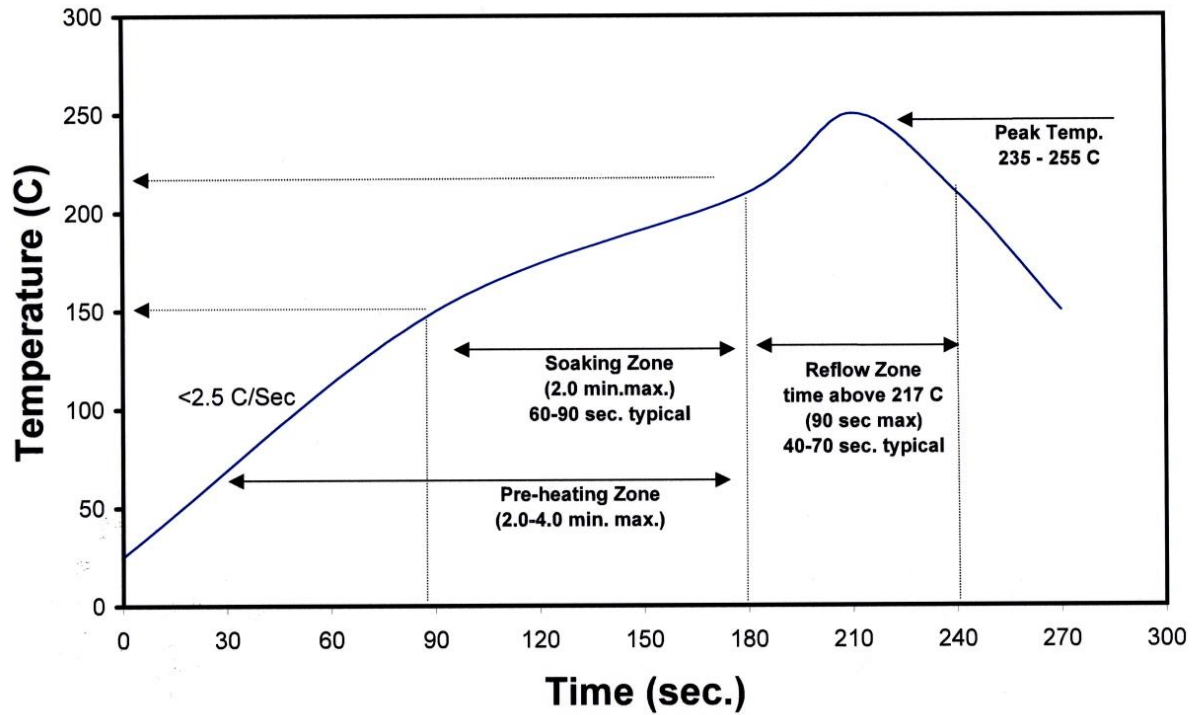

Figure 3: Reflow soldering profile for lead free soldering

## Typical Radiation Pattern

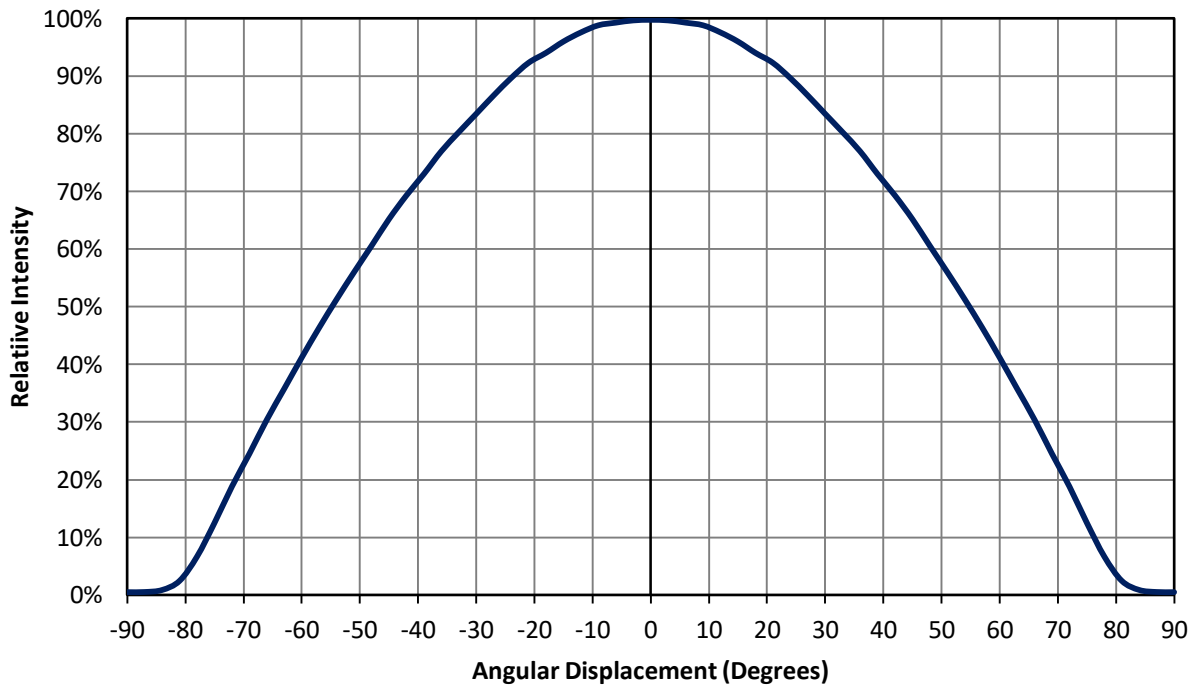

Figure 4: Typical representative spatial radiation pattern



### Typical Relative Spectral Power Distribution

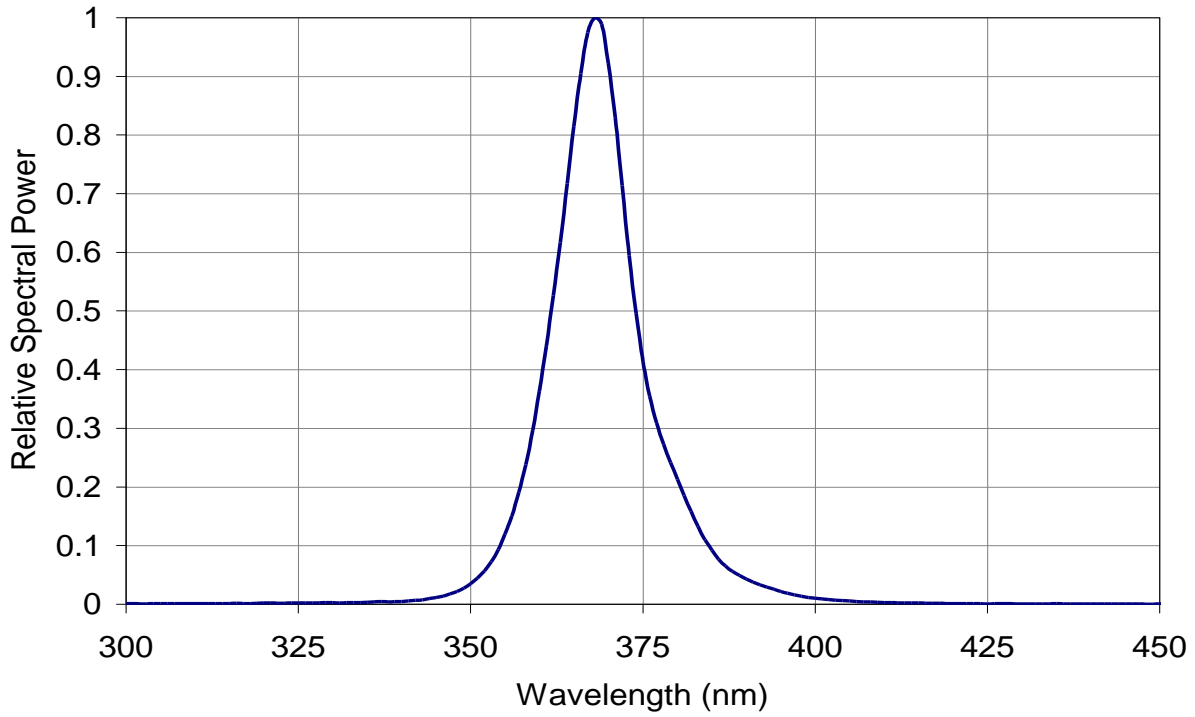

Figure 5: Typical relative spectral power vs. wavelength @ T<sub>c</sub> = 25°C

### Typical Forward Current Characteristics

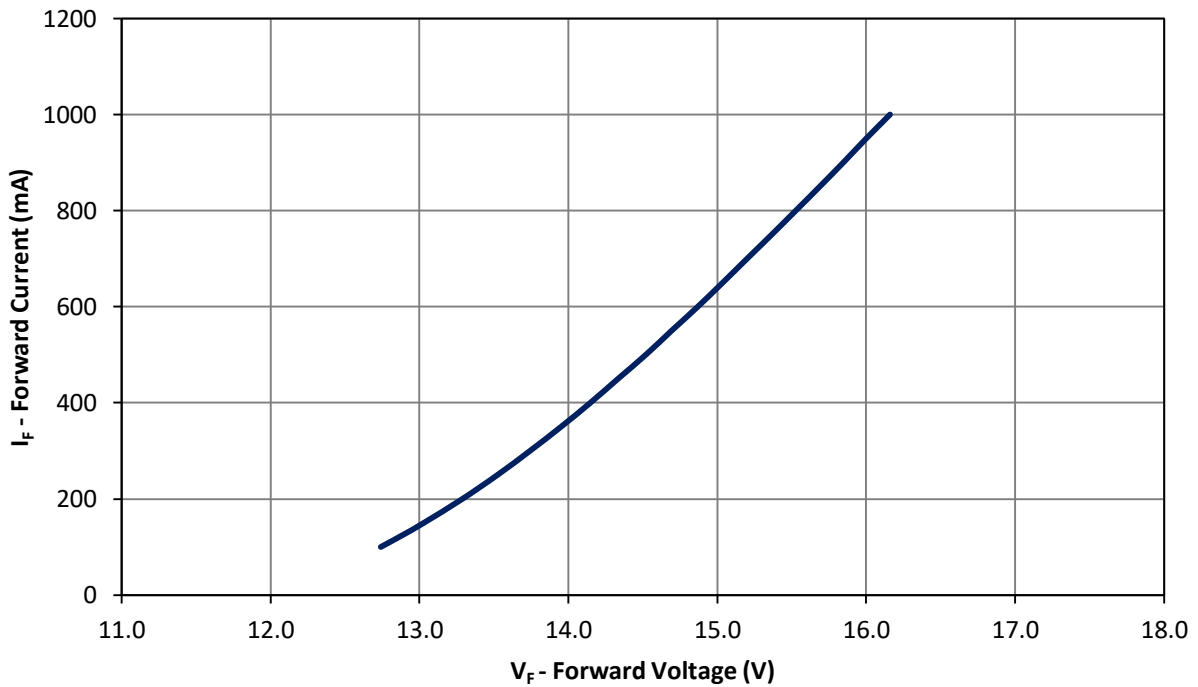

Figure 6: Typical forward current vs. forward voltage @ T<sub>c</sub> = 25°C

### Typical Normalized Radiant Flux over Current

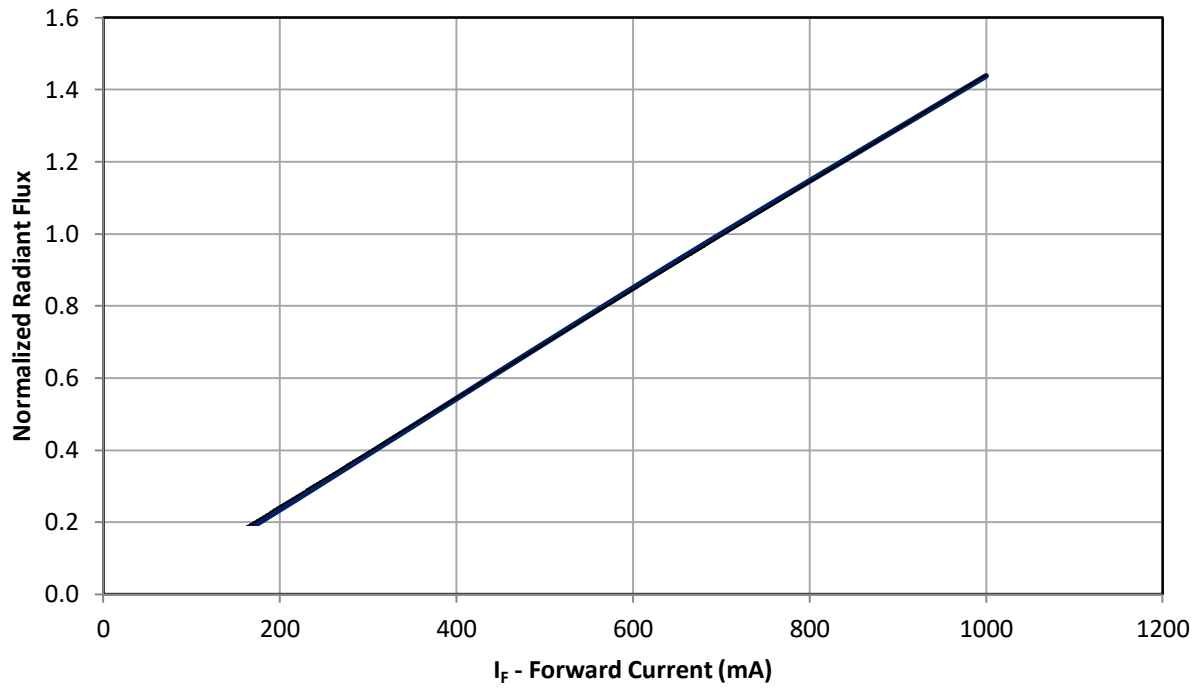

Figure 7: Typical normalized radiant flux vs. forward current @  $T_c = 25^\circ\text{C}$

### Typical Normalized Radiant Flux over Temperature

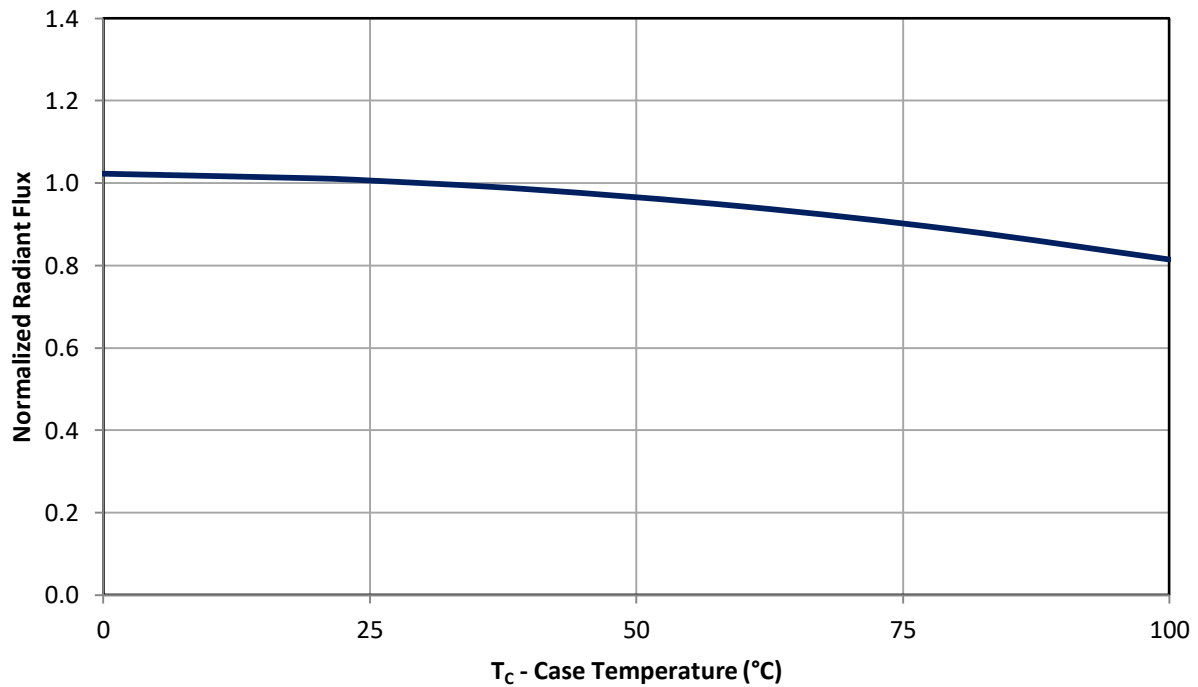

Figure 8: Typical normalized radiant flux vs. case temperature

### Typical Peak Wavelength Shift over Current

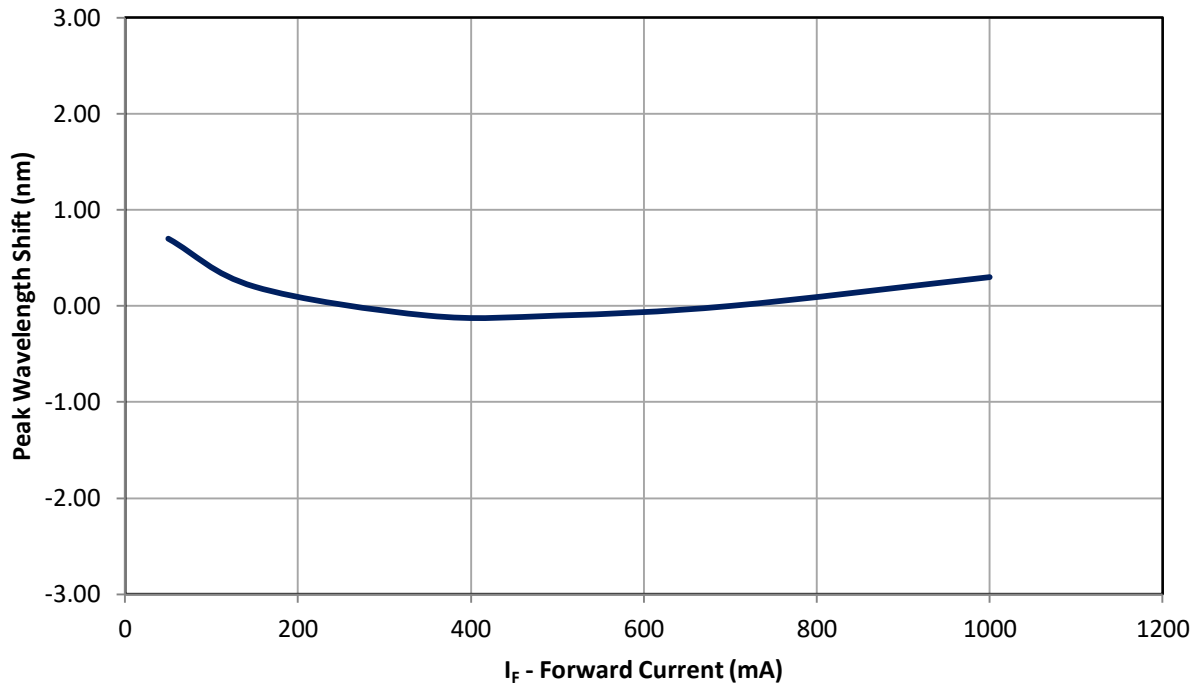

Figure 9: Typical peak wavelength shift vs. forward current @ Tc = 25°C

### Typical Peak Wavelength Shift over Temperature

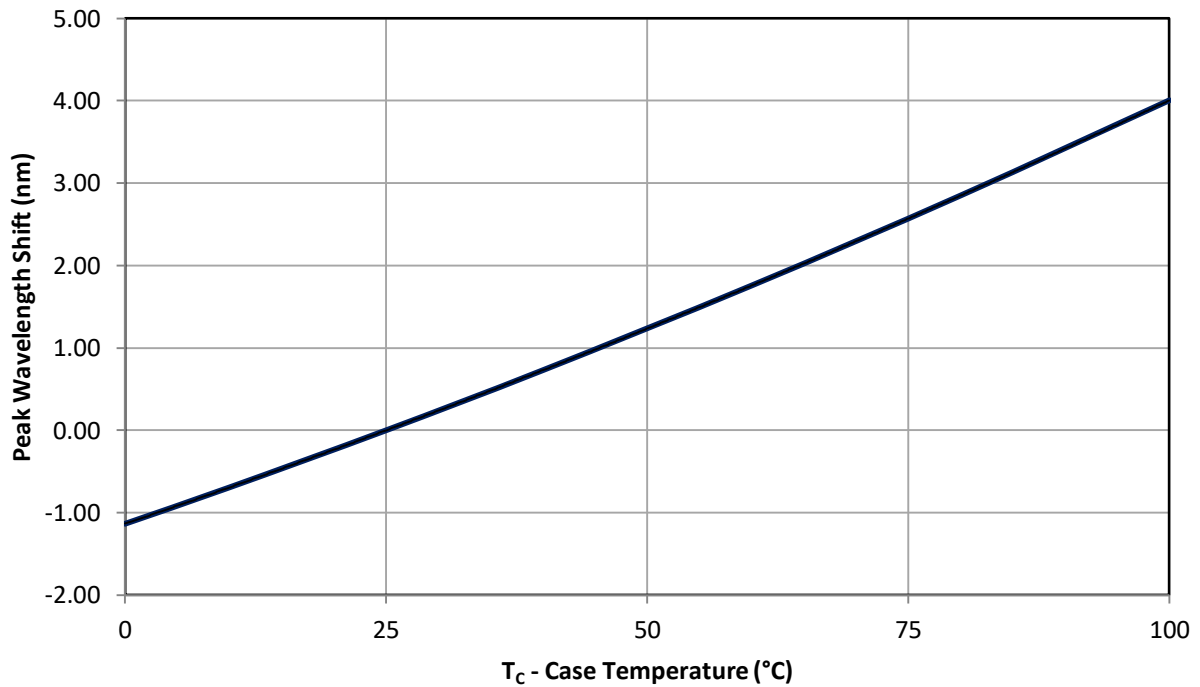

Figure 10: Typical peak wavelength shift vs. case temperature

## Current De-rating

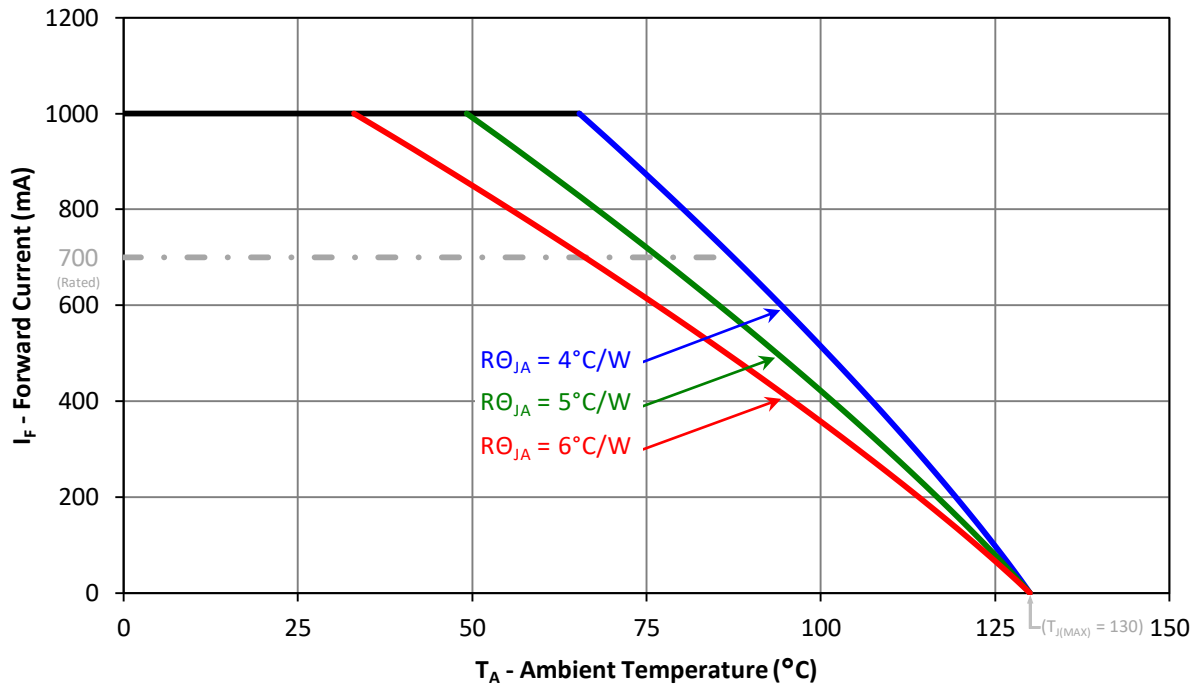

Figure 11: Maximum forward current vs. ambient temperature based on  $T_{J(\text{MAX})} = 130^\circ\text{C}$

Notes for Figure 11:

1.  $R\theta_{JC}$  [Junction to Case Thermal Resistance] for the LZ4-04UV00 is typically  $1.1^\circ\text{C/W}$ .
2.  $R\theta_{JA}$  [Junction to Ambient Thermal Resistance] =  $R\theta_{JC} + R\theta_{CA}$  [Case to Ambient Thermal Resistance].

## Emitter Tape and Reel Specifications (mm)

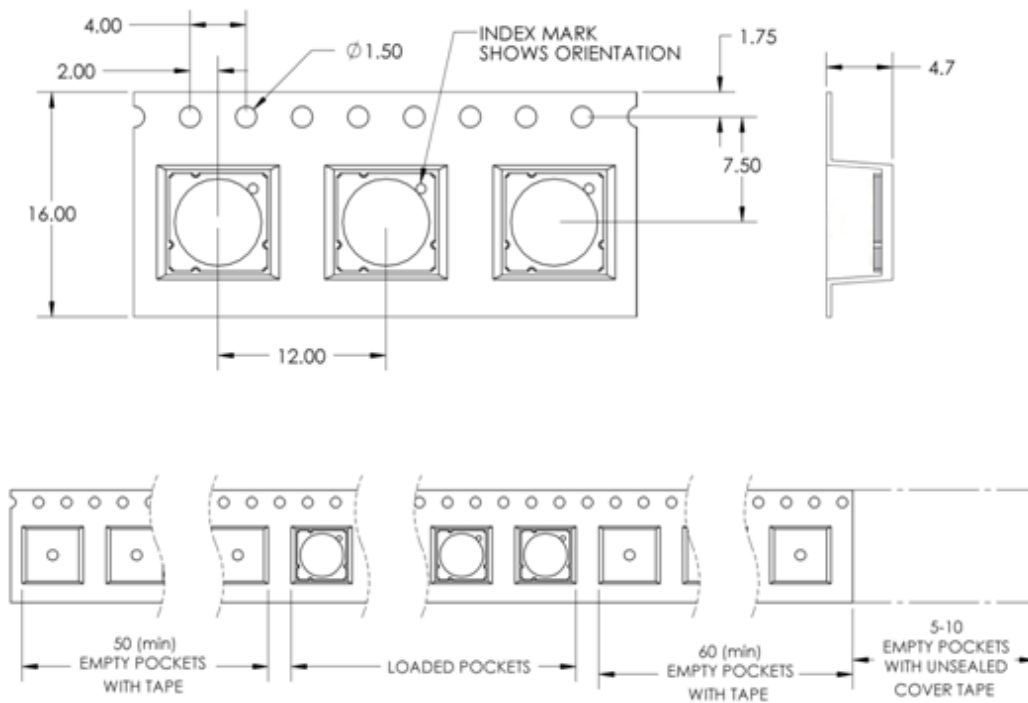

Figure 12: Emitter carrier tape specifications (mm).

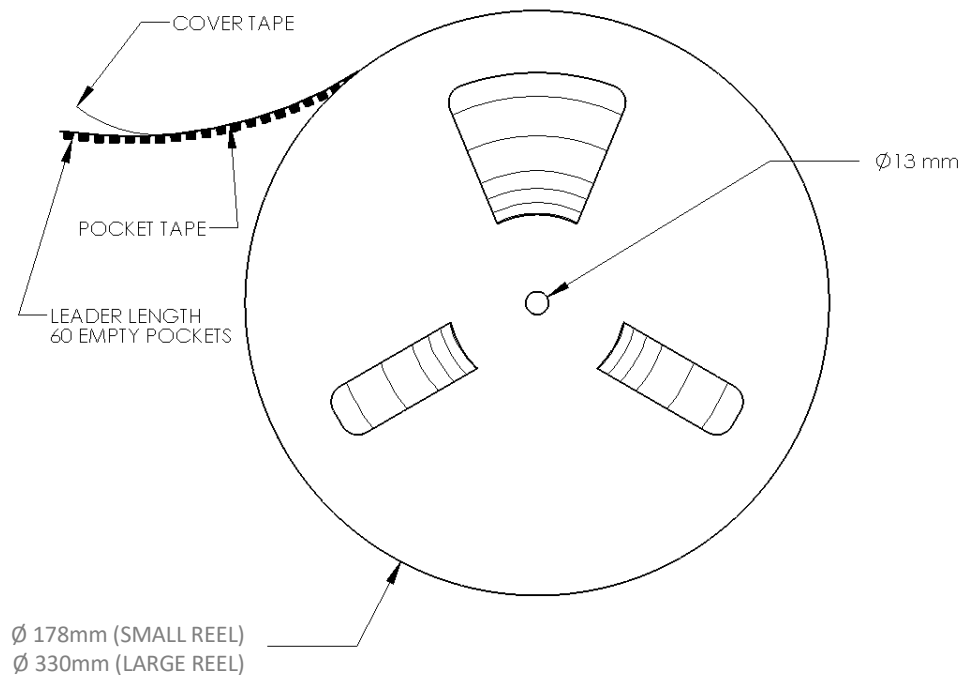

Figure 13: Emitter reel specifications (mm).

Notes for Figure 13:

1. Small reel quantity: up to 250 emitters
2. Large reel quantity: 250-1200 emitters.
3. Single flux bin and single wavelength bin per reel.

# LZ4 MCPCB Family

Part number	Type of MCPCB	Diameter (mm)	Emitter + MCPCB Thermal Resistance (°C/W)	Typical V <sub>F</sub> (V)	Typical I <sub>F</sub> (mA)
LZ4-4xxxxx	1-channel	19.9	1.1 + 1.1 = 2.2	15.2	700

# LZ4-4xxxxx

## 1 channel, Standard Star MCPCB (1x4) Dimensions (mm)

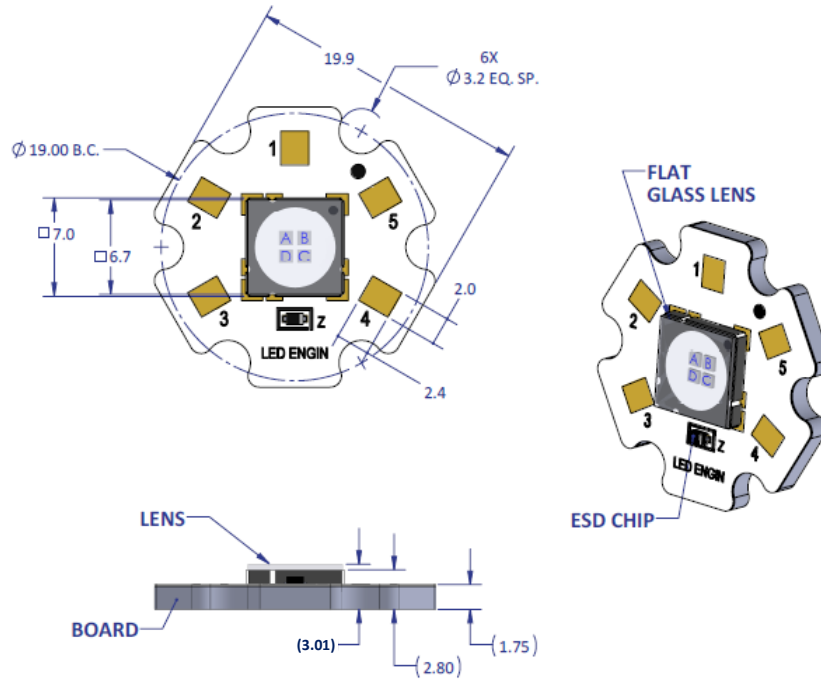

**Notes:**

- Unless otherwise noted, the tolerance =  $\pm 0.2$  mm.
- Slots in MCPCB are for M3 or #4-40 mounting screws.
- LED Engin recommends plastic washers to electrically insulate screws from solder pads and electrical traces.
- LED Engin recommends thermal interface material when attaching the MCPCB to a heatsink
- The thermal resistance of the MCPCB is:  $R\theta_{c-B} 1.1^{\circ}\text{C/W}$

## Components used

MCPCB: HT04503 (Bergquist)  
ESD chips: BZX585-C30 (NXP, for 4 LED dies in series)

Pad layout			
Ch.	MCPCB Pad	String/die	Function
1	1, 2, 3 4, 5	1/ABCD	Cathode - Anode +

## Application Guidelines

### MCPCB Assembly Recommendations

A good thermal design requires an efficient heat transfer from the MCPCB to the heat sink. In order to minimize air gaps in between the MCPCB and the heat sink, it is common practice to use thermal interface materials such as thermal pastes, thermal pads, phase change materials and thermal epoxies. Each material has its pros and cons depending on the design. Thermal interface materials are most efficient when the mating surfaces of the MCPCB and the heat sink are flat and smooth. Rough and uneven surfaces may cause gaps with higher thermal resistances, increasing the overall thermal resistance of this interface. It is critical that the thermal resistance of the interface is low, allowing for an efficient heat transfer to the heat sink and keeping MCPCB temperatures low.

When optimizing the thermal performance, attention must also be paid to the amount of stress that is applied on the MCPCB. Too much stress can cause the ceramic emitter to crack. To relax some of the stress, it is advisable to use plastic washers between the screw head and the MCPCB and to follow the torque range listed below. For applications where the heat sink temperature can be above 50°C, it is recommended to use high temperature and rigid plastic washers, such as polycarbonate or glass-filled nylon.

LED Engin recommends the use of the following thermal interface materials:

1. Bergquist's Gap Pad 5000S35, 0.020in thick
  - Part Number: Gap Pad® 5000S35 0.020in/0.508mm
  - Thickness: 0.020in/0.508mm
  - Thermal conductivity: 5 W/m-K
  - Continuous use max temperature: 200°C
  - Using M3 Screw (or #4 screw), with polycarbonate or glass-filled nylon washer (#4) the recommended torque range is: 20 to 25 oz-in (1.25 to 1.56 lbf-in or 0.14 to 0.18 N-m)
  
2. 3M's Acrylic Interface Pad 5590H
  - Part number: 5590H @ 0.5mm
  - Thickness: 0.020in/0.508mm
  - Thermal conductivity: 3 W/m-K
  - Continuous use max temperature: 100°C
  - Using M3 Screw (or #4 screw), with polycarbonate or glass-filled nylon washer (#4) the recommended torque range is: 20 to 25 oz-in (1.25 to 1.56 lbf-in or 0.14 to 0.18 N-m)

### Mechanical Mounting Considerations

The mounting of MCPCB assembly is a critical process step. Excessive mechanical stress build up in the MCPCB can cause the MCPCB to warp which can lead to emitter substrate cracking and subsequent cracking of the LED dies

LED Engin recommends the following steps to avoid mechanical stress build up in the MCPCB:

- Inspect MCPCB and heat sink for flatness and smoothness.
- Select appropriate torque for mounting screws. Screw torque depends on the MCPCB mounting method (thermal interface materials, screws, and washer).
- Always use three M3 or #4-40 screws with #4 washers.
- When fastening the three screws, it is recommended to tighten the screws in multiple small steps. This method avoids building stress by tilting the MCPCB when one screw is tightened in a single step.
- Always use plastic washers in combinations with the three screws. This avoids high point contact stress on the screw head to MCPCB interface, in case the screw is not seated perpendicular.
- In designs with non-tapped holes using self-tapping screws, it is common practice to follow a method of three turns tapping a hole clockwise, followed by half a turn anti-clockwise, until the appropriate torque is reached.



## Wire Soldering

- To ease soldering wire to MCPCB process, it is advised to preheat the MCPCB on a hot plate of 125-150°C. Subsequently, apply the solder and additional heat from the solder iron will initiate a good solder reflow. It is recommended to use a solder iron of more than 60W.
- It is advised to use lead-free, no-clean solder. For example: SN-96.5 AG-3.0 CU 0.5 #58/275 from Kester (pn: 24-7068-7601)

## About LED Engin

LED Engin, an OSRAM business based in California's Silicon Valley, develops, manufactures, and sells advanced LED emitters, optics and light engines to create uncompromised lighting experiences for a wide range of entertainment, architectural, general lighting and specialty applications. LuxiGen™ multi-die emitter and secondary lens combinations reliably deliver industry-leading flux density, upwards of 5000 quality lumens to a target, in a wide spectrum of colors including whites, tunable whites, multi-color and UV LEDs in a unique patented compact ceramic package. Our LuxiTune™ series of tunable white lighting modules leverage our LuxiGen emitters and lenses to deliver quality, control, freedom and high density tunable white light solutions for a broad range of new recessed and downlighting applications. The small size, yet remarkably powerful beam output and superior in-source color mixing, allows for a previously unobtainable freedom of design wherever high-flux density, directional light is required. LED Engin is committed to providing products that conserve natural resources and reduce greenhouse emissions; and reserves the right to make changes to improve performance without notice.

For more information, please contact [LEDE-Sales@osram.com](mailto:LEDE-Sales@osram.com) or +1 408 922-7200.

Компания «Life Electronics» занимается поставками электронных компонентов импортного и отечественного производства от производителей и со складов крупных дистрибьюторов Европы, Америки и Азии.

С конца 2013 года компания активно расширяет линейку поставок компонентов по направлению коаксиальный кабель, кварцевые генераторы и конденсаторы (керамические, пленочные, электролитические), за счёт заключения дистрибьюторских договоров

Мы предлагаем:

- Конкуренспособные цены и скидки постоянным клиентам.
- Специальные условия для постоянных клиентов.
- Подбор аналогов.
- Поставку компонентов в любых объемах, удовлетворяющих вашим потребностям.
- Приемлемые сроки поставки, возможна ускоренная поставка.
- Доставку товара в любую точку России и стран СНГ.
- Комплексную поставку.
- Работу по проектам и поставку образцов.
- Формирование склада под заказчика.
- Сертификаты соответствия на поставляемую продукцию (по желанию клиента).
- Тестирование поставляемой продукции.
- Поставку компонентов, требующих военную и космическую приемку.
- Входной контроль качества.
- Наличие сертификата ISO.

В составе нашей компании организован Конструкторский отдел, призванный помогать разработчикам, и инженерам.

Конструкторский отдел помогает осуществить:

- Регистрацию проекта у производителя компонентов.
- Техническую поддержку проекта.
- Защиту от снятия компонента с производства.
- Оценку стоимости проекта по компонентам.
- Изготовление тестовой платы монтаж и пусконаладочные работы.



Тел: +7 (812) 336 43 04 (многоканальный)  
Email: [org@lifeelectronics.ru](mailto:org@lifeelectronics.ru)