

FLT012A0Z/FLT012A0-SZ: Input Filter Modules

75Vdc Input Voltage Maximum; 12A Output Current Maximum



RoHS Compliant

Applications

- Distributed power architectures
- Wireless Networks
- Enterprise Networks
- Access and Optical Network Equipment

Options

- Surface Mount Interconnect (-S)

Description

The Filter module shall be designed to operate over an input voltage range up to 75Vdc at output current of 12A in an ambient temperature of -40°C to 85°C. The filter module shall be optimized for use with dc/dc converter modules, to significantly reduce the conducted differential and common-mode noise returned to the power source. The filter module shall enable designers to meet the requirements of EMI standards CISPR 22 (EN55022) and FCC Class B by inserting in-line between the power source and the dc/dc converter module. These modules shall be designed and manufactured to be either surface mounted(-S version) or through hole mounted on PCBs.

Features

- Compliant to RoHS EU Directive Directive 2011/65/EU (Z versions)
- Compatible in a Pb-free or SnPb reflow environment (Z versions)
- Surface Mount and Through hole versions
- Common-mode and Differential-mode filtering
- Small size and low profile
48.3 mm x 25.4 mm x 11.7 mm
(1.9 in x 1.0 in x 0.46 in)
- Same footprint as FLTR100V10 module
- Cost efficient open frame design
- Wide operating temperature range (-40°C to +85°C)
- Meets the voltage isolation requirements for ETSI 300-132-2
- *UL** 60950-1, 2nd Ed. Recognized, *CSA*† C22.2 No. 60950-1-07 Certified, and *VDE*‡(EN60950-1, 2nd Ed.) Licensed
- CE mark meets 2006/95/EC directives§
- ISO** 9001 and ISO 14001 certified manufacturing facilities

* *UL* is a registered trademark of Underwriters Laboratories, Inc.

† *CSA* is a registered trademark of Canadian Standards Association.

‡ *VDE* is a trademark of Verband Deutscher Elektrotechniker e.V.

** ISO is a registered trademark of the International Organization of Standards

§ This product is intended for integration into end-user equipment . All of the required procedures of end-use equipment should be followed.

FLT012A0Z/FLT012A0-SZ: Input Filter Modules

75Vdc Input Voltage Maximum; 12A Output Current Maximum

Absolute Maximum Ratings

Stresses in excess of the absolute maximum ratings can cause permanent damage to the device. These are absolute stress ratings only, functional operation of the device is not implied at these or any other conditions in excess of those given in the operations sections of the data sheet. Exposure to absolute maximum ratings for extended periods can adversely affect the device reliability.

Parameter	Device	Symbol	Min	Max	Unit
Input Voltage	All	V_{IN}	0	75	Vdc
		$V_{IN, TRANS}$	0	100	V
Operating Ambient Temperature	All	T_A	-40	85	°C
Storage Temperature	All	T_{stg}	-55	125	°C
I/O to Ground Isolation (100% Factory Tested)	FLT012A0Z / FLT012A0-SZ	-	-	1500	Vdc
	FLT012A0-11Z	-	-	2000	Vdc
Input to GND Insulation			10	-	MΩ

Electrical Specifications

Unless otherwise indicated, specifications apply over all operating input voltage, resistive load, and temperature conditions.

Parameter	Device	Symbol	Min	Typ	Max	Unit
Operating Input Voltage	All	V_{IN}	0	24/48	75	Vdc
Maximum Input-to-Output Current ($V_{IN} = 0$ to $V_{IN, max}$)	All	I_{max}			12	Adc
Resistance per leg	All	R			20	mΩ
Maximum Average Current ($T_A = 60^\circ\text{C}$, 2.03 m/s (400lfm) air)		I_{max}			12	A
Maximum Average Current ($T_A = 60^\circ\text{C}$, natural convection)		I_{max}			8	A

CAUTION: This power module is not internally fused. An input line fuse must always be used.

This power module can be used in a wide variety of applications, ranging from simple standalone operation to an integrated part of sophisticated power architecture. To preserve maximum flexibility, internal fusing is not included, however, to achieve maximum safety and system protection, always use an input line fuse. The safety agencies require a fast-acting fuse with a maximum rating of 15 A (see Safety Considerations section). Based on the information provided in this data sheet on inrush energy and maximum dc input current, the same type of fuse with a lower rating can be used. Refer to the fuse manufacturer's data sheet for further information.

FLT012A0Z/FLT012A0-SZ: Input Filter Modules

75Vdc Input Voltage Maximum; 12A Output Current Maximum

Insertion Loss Tables – Standard Version

Parameter	Device	Symbol	Min	Typ	Max	Unit
Common-mode Insertion Loss						
50Ω circuit, 500kHz	All		41	45		dB
50Ω circuit, 1MHz	All		51	56		dB
50Ω circuit, 10MHz	All		69	75		dB
Differential-mode Insertion Loss						
50Ω circuit, 500kHz	All		50	55		dB
50Ω circuit, 1MHz	All		52	57		dB
50Ω circuit, 10MHz	All		48	53		dB

Insertion Loss Tables – 11 version (2000V withstand)

Parameter	Device	Symbol	Min	Typ	Max	Unit
Common-mode Insertion Loss						
50Ω circuit, 500kHz	All		42	45		dB
50Ω circuit, 1MHz	All		52	56		dB
50Ω circuit, 10MHz	All		70	75		dB
Differential-mode Insertion Loss						
50Ω circuit, 500kHz	All		51	55		dB
50Ω circuit, 1MHz	All		53	57		dB
50Ω circuit, 10MHz	All		49	53		dB

General Specifications

Parameter	Min	Typ	Max	Unit
Calculated MTBF ($V_{IN}=V_{IN,nom}$, $I_o=0.8I_{o,max}$, $T_A=40^{\circ}C$) Telecordia SR 332 Issue 2: Method 1, case 3		150,609,226		Hours
Weight	—	12 (0.42)	—	g (oz.)

FLT012A0Z/FLT012A0-SZ: Input Filter Modules

75Vdc Input Voltage Maximum; 12A Output Current Maximum

Characteristic Curves

The following figures provide typical characteristics for the FLT012A0 Module.

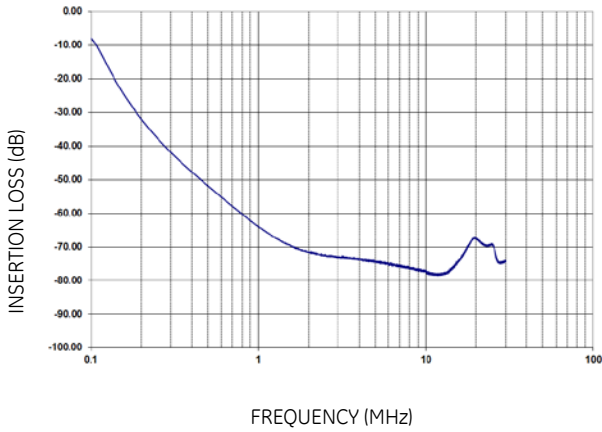

Figure 1: Typical Common-Mode Insertion Loss in a 50Ω circuit (Standard Version, 100MHz Axis max.)

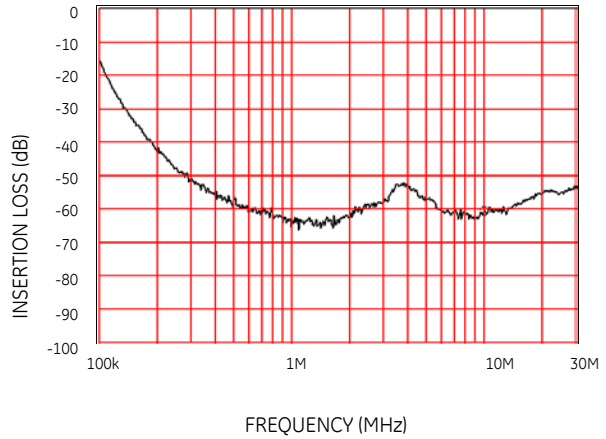

Figure 4: Typical Differential-Mode Insertion Loss in a 50Ω circuit. (-11 Option, 30MHz Axis max.)

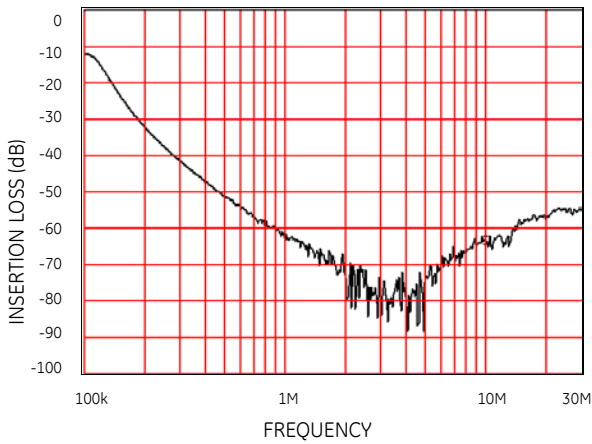

Figure 2: Typical Common-Mode Insertion Loss in a 50Ω circuit. (-11 Option, 30MHz Axis max.)

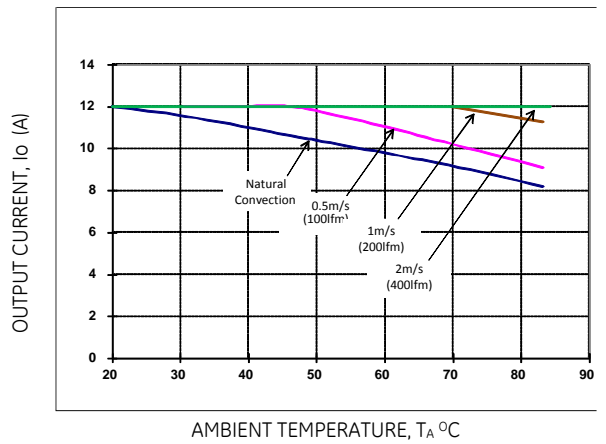

Figure 5: Derating Output Current versus Local Ambient Temperature and Airflow.

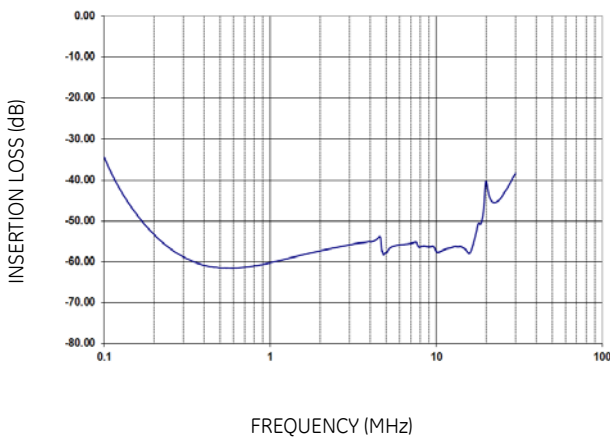

Figure 3: Typical Differential-Mode Insertion Loss in a 50Ω circuit. (Standard Version, 100MHz Axis max.)

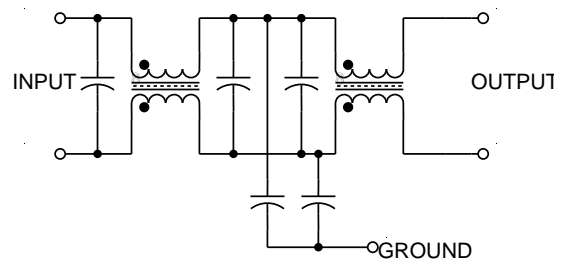

Figure 6. Internal Schematic

FLT012A0Z/FLT012A0-SZ: Input Filter Modules

75Vdc Input Voltage Maximum; 12A Output Current Maximum

Application Guidelines

Conducted noise on the input power lines can occur as either differential-mode or common-mode noise currents. Differential-mode noise is measured between the two input lines, and is found mostly at the low frequency end of the spectrum. This noise shows up as noise at the fundamental switching frequency and its harmonics. Common-mode noise is measured between the input lines and ground and is mostly broadband noise above 10 MHz. The high-frequency nature of common-mode noise is mostly due to the high-speed switching transitions of power train components. Either or both types of noise may be covered in a specification, as well as a combination of the two.

Differential-mode noise is best attenuated using a filter composed of line-to-line capacitors (X caps) and series inductance, provided by either a discrete inductor or the leakage inductance of a common-mode choke. In addition to the differential filtering provided by the filter module, it is recommended that an electrolytic capacitor be located at the converter side of the filter to provide additional attenuation of low-frequency differential noise and to provide a low source impedance for the converter, preventing input filter oscillations and load transient induced input voltage dips.

Open-frame DC/DC converter modules and the older metal-cased DC/DC converter modules require slightly different filtering arrangements. The FLT012A0 series of modules are optimized for the newer open-frame series of modules, but can also be used with older metal-case modules. The main differences in filtering recommendations between the two types of modules are in common-mode filtering, as explained below.

Filtering Open-Frame DC/DC Converter Modules

For filtering open-frame DC/DC converter modules, the recommended circuit is shown in Fig. 7. In addition to the input electrolytic filter capacitor C1 (recommended value is a minimum of 100uF and approximately 1uF/W at power levels above 100W), common-mode filtering capacitors C2 and C3 should be connected between the input and outputs as shown. Suitable values for common-mode capacitors C2 and C3 are in the range between 1000pF to 0.1uF are usually indicated in the DC/DC converter data sheet. These capacitors need to be rated for the isolation voltage desired between the input and output sides of the DC/DC converter module. The recommended power layout of the modules showing where the two common-mode capacitors are to be placed is shown in Fig. 8.

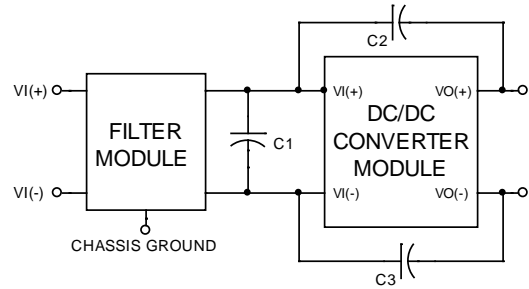

Figure 7. Schematic diagram showing recommended connection of the FLT012A0 filter module with open-frame DC/DC converter modules.

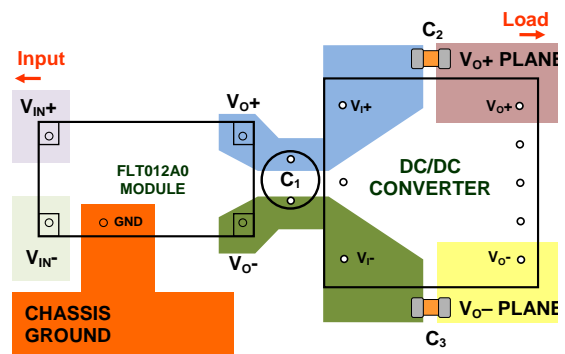

Figure 8. Diagram showing recommended layout of the FLT012A0 filter module with open-frame DC/DC converter modules.

Filtering Metal-Case DC/DC Converter Modules

For metal-case DC/DC converter modules with a case pin, a different filtering arrangement and layout is recommended. Figure 9 shows the schematic diagram of the recommended circuit. The main difference with open-frame module is the use of an isolated shield plane located underneath the module which is connected through capacitors C2 through C5 to the input and output connections of the module. The shield plane along with the case of the module serves as a Faraday shield helping reduce EMI. The corresponding layout for metal-case modules is shown in Fig. 10.

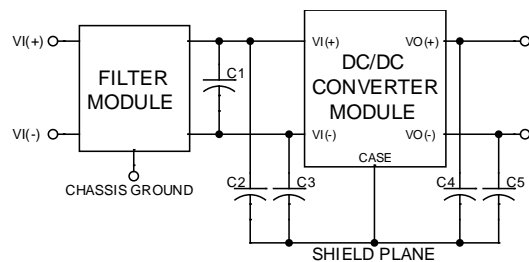

Figure 9. Schematic diagram showing recommended connection of the FLT012A0 filter module with metal-cased DC/DC converter modules.

FLT012A0Z/FLT012A0-SZ: Input Filter Modules

75Vdc Input Voltage Maximum; 12A Output Current Maximum

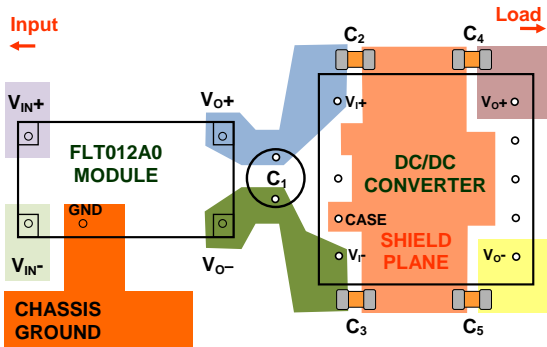

Figure 10. Diagram showing recommended layout of the FLT012A0 filter module with metal-case DC/DC converter modules.

Example Data Showing Results using the FLT012A0 Modules

Figure 11 shows example results obtained using a QBVW033 DC/DC converter module with the FLT012A0 filter module. The QBVW033 module is operated at an input voltage of 48V and output loading corresponding to an input current of 8.7A, a level close to the 12A capability of the FLT012A0 filter module. Board capacitance was as per recommendations in the QBVW033 datasheet. The results show that the filter module is capable of meeting EN55022 Class A limits with 11 dB margin.

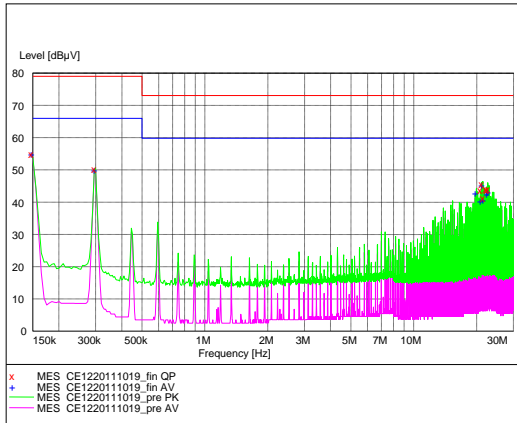

Figure 11. Experimental results showing conducted EMI measured using a FLT012A0 module with a QBVW033 DC/DC converter.

FLT012A0Z/FLT012A0-SZ: Input Filter Modules
 75Vdc Input Voltage Maximum; 12A Output Current Maximum

Thermal Considerations

Power modules operate in a variety of thermal environments; however, sufficient cooling should always be provided to help ensure reliable operation.

Considerations include ambient temperature, airflow, module power dissipation, and the need for increased reliability. A reduction in the operating temperature of the module will result in an increase in reliability. The thermal data presented here is based on physical measurements taken in a wind tunnel. The test set-up is shown in Fig. 12. Note that the airflow is parallel to the long axis of the module as shown in Fig. 12.

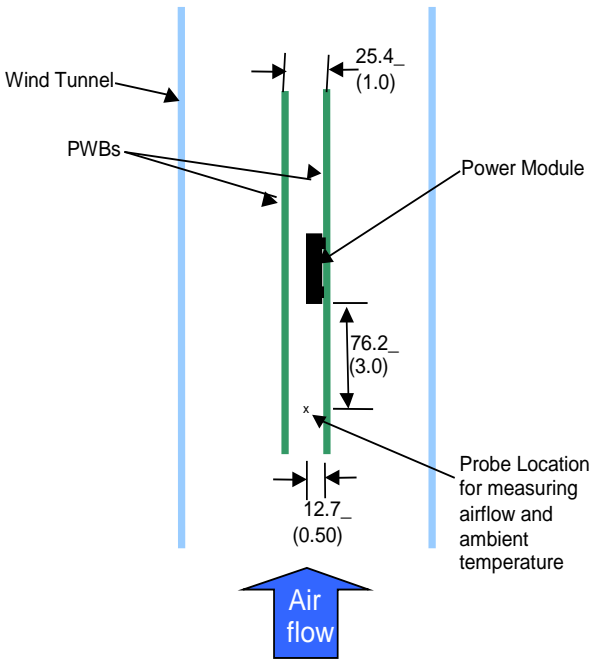

Figure 12. Thermal Test Set-up.

The thermal reference point, T_{ref} used in the specifications is shown in Figure 13. For reliable operation this temperature should not exceed 130°C.

The output power of the module should not exceed the rated output current of the module.

Please refer to the Application Note “Thermal Characterization Process For Open-Frame Board-Mounted Power Modules” for a detailed discussion of thermal aspects including maximum device temperatures.

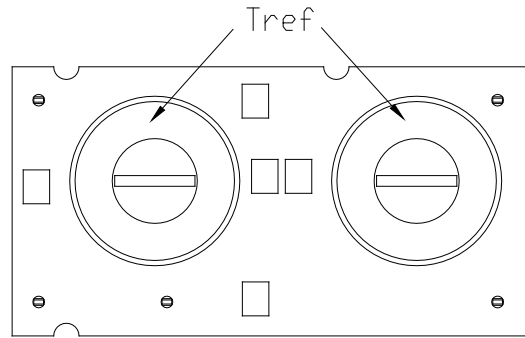

Figure 13. T_{ref} Temperature measurement location.

FLT012A0Z/FLT012A0-SZ: Input Filter Modules

75Vdc Input Voltage Maximum; 12A Output Current Maximum

Surface Mount Information

Pick and Place

The FLT012A0-SR SMT modules use an open frame construction and are designed for a fully automated assembly process. The modules are fitted with a label designed to provide a large surface area for pick and place operations. The label meets all the requirements for surface mount processing, as well as safety standards, and is able to withstand reflow temperatures of up to 300°C. The label also carries product information such as product code, serial number and location of manufacture.

Nozzle Recommendations

The module weight has been kept to a minimum by using open frame construction. Even so, these modules have a relatively large mass when compared to conventional SMT components. Variables such as nozzle size, tip style, vacuum pressure and pick & placement speed should be considered to optimize this process. The minimum recommended nozzle diameter for reliable operation is 5 mm. The maximum nozzle outer diameter, which will safely fit within the allowable component spacing, is 8 mm max.

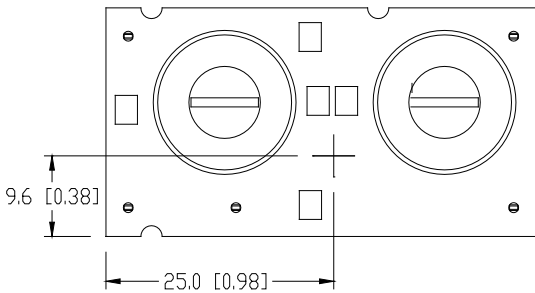

Figure 14: Pick and Place Location.

Bottom Side / First Side Assembly

This module is not recommended for assembly on the bottom side of a customer board. If such an assembly is attempted, components may fall off the module during the second reflow process.

Tin Lead Soldering

The FLT012A0-SZ power modules are lead free modules and can be soldered either in a lead-free solder process or in a conventional Tin/Lead (Sn/Pb) process. It is recommended that the customer review data sheets in order to customize the solder reflow profile for each application board assembly. The following instructions must be observed when soldering these units. Failure to observe these instructions may result in the failure of or cause damage to the modules, and can adversely affect long-term reliability.

In a conventional Tin/Lead (Sn/Pb) solder process peak reflow temperatures are limited to less than 235°C. Typically, the eutectic solder melts at 183°C, wets the land, and subsequently wicks the device connection. Sufficient

time must be allowed to fuse the plating on the connection to ensure a reliable solder joint. There are several types of SMT reflow technologies currently used in the industry. These surface mount power modules can be reliably soldered using natural forced convection, IR (radiant infrared), or a combination of convection/IR. For reliable soldering the solder reflow profile should be established by accurately measuring the modules CP connector temperatures.

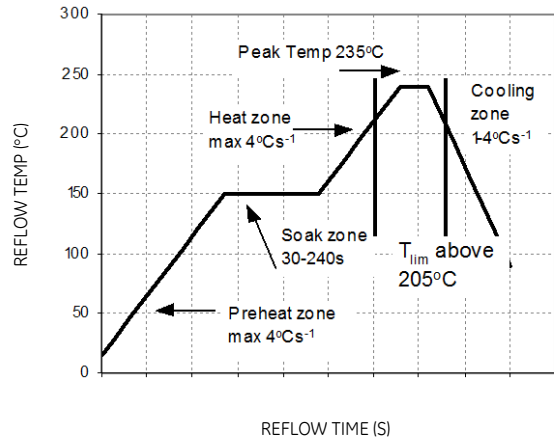

Figure 15: Reflow Profile for Tin/Lead (Sn/Pb) process.

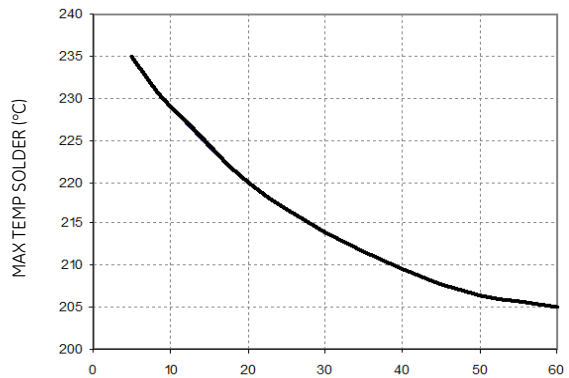

Figure 16: Time Limit Curve Above 205°C Reflow for Tin Lead (Sn/Pb) process.

Lead Free Soldering

The FLT012A0-SZ SMT modules are lead-free (Pb-free) and RoHS compliant and are both forward and backward compatible in a Pb-free and a SnPb soldering process. Failure to observe the instructions below may result in the failure of or cause damage to the modules and can adversely affect long-term reliability.

Pb-free Reflow Profile

Power Systems will comply with J-STD-020 Rev. C (Moisture/Reflow Sensitivity Classification for Nonhermetic Solid State Surface Mount Devices) for both Pb-free solder profiles and MSL classification procedures. This standard provides a recommended forced-air-convection reflow profile based on the volume and thickness of the package

FLT012A0Z/FLT012A0-SZ: Input Filter Modules

75Vdc Input Voltage Maximum; 12A Output Current Maximum

(table 4-2). The suggested Pb-free solder paste is Sn/Ag/Cu (SAC). The recommended linear reflow profile using Sn/Ag/Cu solder is shown in Figure. 17. Soldering outside of the recommended profile requires testing to verify results and performance.

MSL Rating

The FLT012A0-SRZ SMT modules have a MSL rating of 2a.

Storage and Handling

The recommended storage environment and handling procedures for moisture-sensitive surface mount packages is detailed in J-STD-033 Rev. A (Handling, Packing, Shipping and Use of Moisture/Reflow Sensitive Surface Mount Devices). Moisture barrier bags (MBB) with desiccant are required for MSL ratings of 2 or greater. These sealed packages should not be broken until time of use. Once the original package is broken, the floor life of the product at conditions of <= 30°C and 60% relative humidity varies according to the MSL rating (see J-STD-033A). The shelf life for dry packed SMT packages will be a minimum of 12 months from the bag seal date, when stored at the following conditions: < 40° C, < 90% relative humidity.

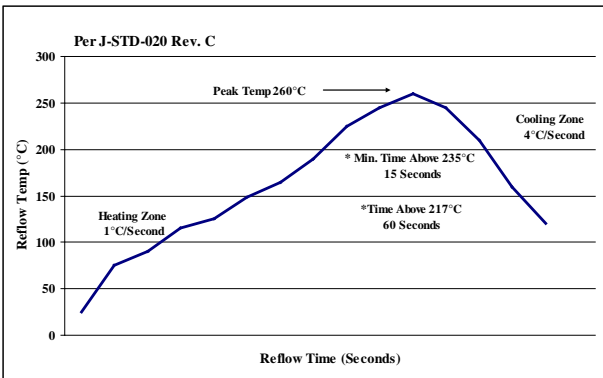

Figure 17. Recommended linear reflow profile using Sn/Ag/Cu solder.

Post solder Cleaning and Drying Considerations

Post solder cleaning is usually the final circuit-board assembly process prior to electrical board testing. The result of inadequate cleaning and drying can affect both the reliability of a power module and the testability of the finished circuit-board assembly. For guidance on appropriate soldering, cleaning and drying procedures, refer to GE Board Mounted Power Modules: Soldering and Cleaning Application Note.(AN04-001)

Through-Hole Lead-Free Soldering Information

The RoHS-compliant through-hole products use the SAC (Sn/Ag/Cu) Pb-free solder and RoHS-compliant components. They are designed to be processed through single or dual wave soldering machines. The pins have an RoHS-compliant finish that is compatible with both Pb and Pb-free wave soldering processes. A maximum preheat rate of 3°C/s is suggested. The wave preheat process should be such that the temperature of the power module board is kept below 210°C. For Pb solder, the recommended pot temperature is 260°C, while the Pb-free solder pot is 270°C max. Not all RoHS-compliant through-hole products can be processed with paste-through-hole Pb or Pb-free reflow process. If additional information is needed, please consult with your GE representative for more details.

FLT012A0Z/FLT012A0-SZ: Input Filter Modules
 75Vdc Input Voltage Maximum; 12A Output Current Maximum

Mechanical Outline

Dimensions are in millimeters and [inches].

Tolerances: x.x mm ± 0.5 mm [x.xx in. ± 0.02 in.] (Unless otherwise indicated)

x.xx mm ± 0.25 mm [x.xxx in ± 0.010 in.]

TOP VIEW

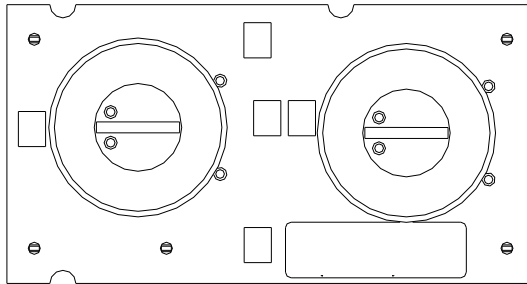

SIDE VIEW

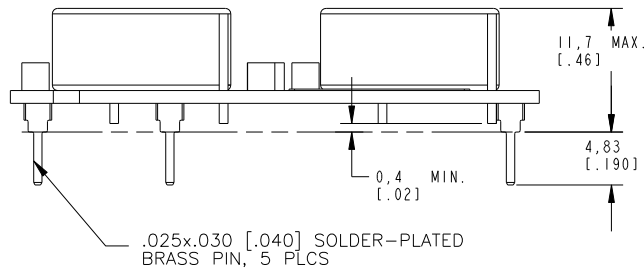

BOTTOM VIEW

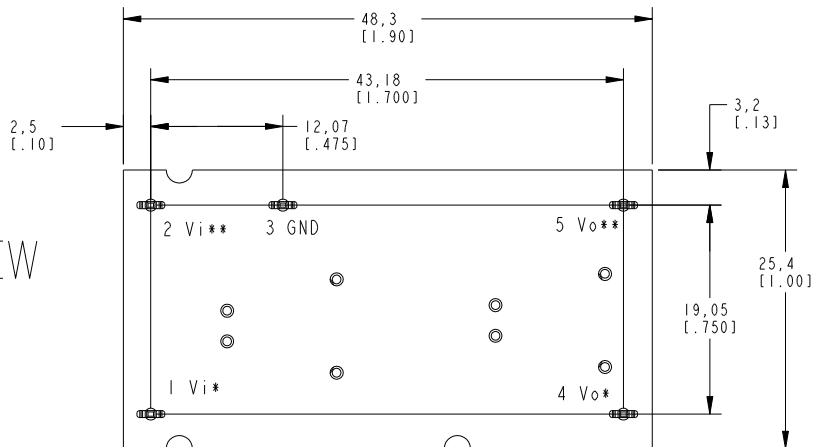

- * - May be either + or – polarity, but must be same for pin 1 and 4.
- ** - Pin 2 and 5 shall be polarity that is opposite from pins 1 and 4.

FLT012AZ (Through Hole Version)

FLT012A0Z/FLT012A0-SZ: Input Filter Modules
 75Vdc Input Voltage Maximum; 12A Output Current Maximum

Surface Mount Outline Drawing

Dimensions are in millimeters and [inches].

Tolerances: x.x mm ± 0.5 mm [x.xx in. ± 0.02 in.] (Unless otherwise indicated)

x.xx mm ± 0.25 mm [x.xxx in ± 0.010 in.]

TOP VIEW

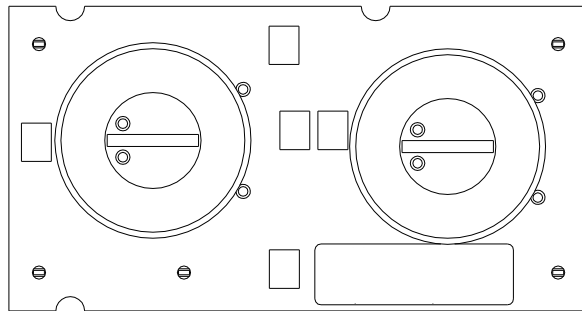

SIDE VIEW

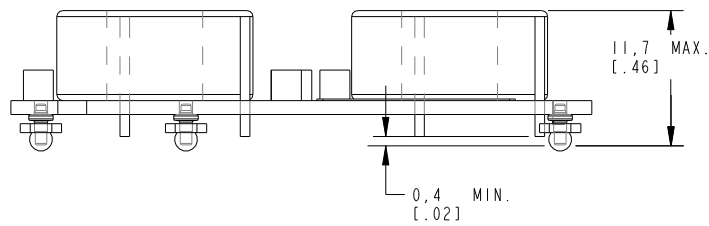

BOTTOM VIEW

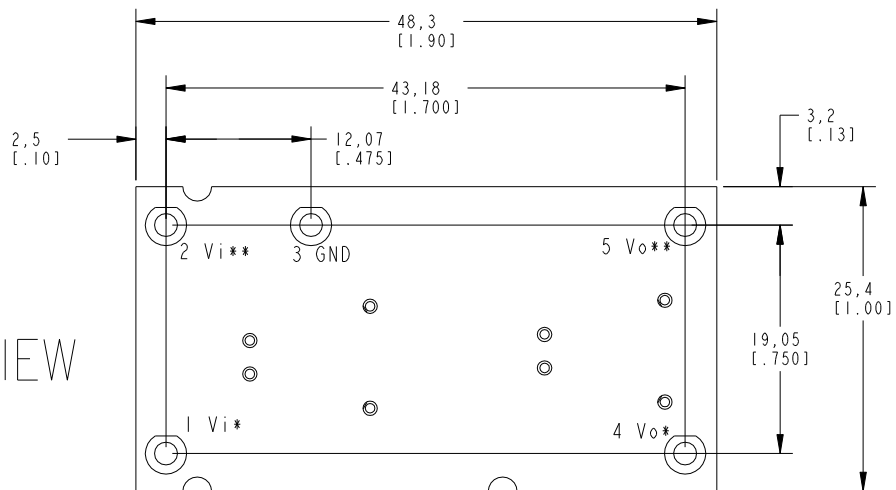

* - May be either + or – polarity, but must be same for pin 1 and 4.

** - Pin 2 and 5 shall be polarity that is opposite from pins 1 and 4.

FLT012A0Z/FLT012A0-SZ: Input Filter Modules

75Vdc Input Voltage Maximum; 12A Output Current Maximum

Recommended Pad Layout

Dimensions are in millimeters and [inches].

Tolerances: x.x mm ± 0.5 mm [x.xx in. ± 0.02 in.] (Unless otherwise indicated)

x.xx mm ± 0.25 mm [x.xxx in ± 0.010 in.]

FLT012A0 (Through Hole Version)

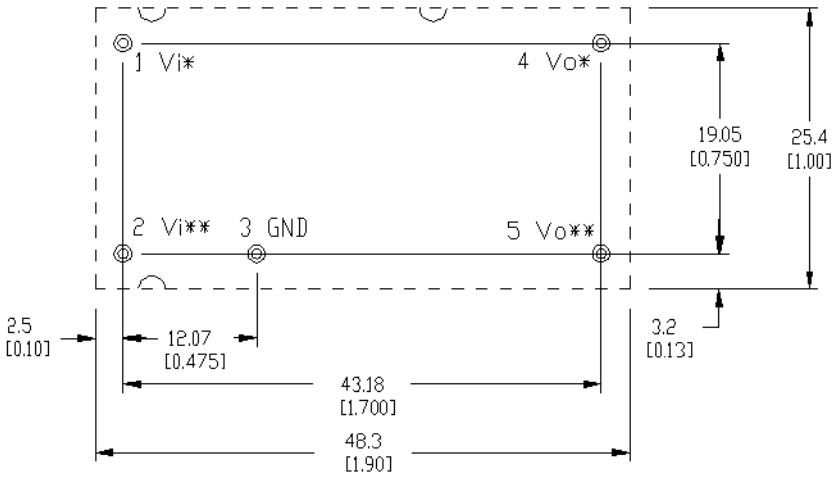

FLT012A0-SZ (SMT Version)

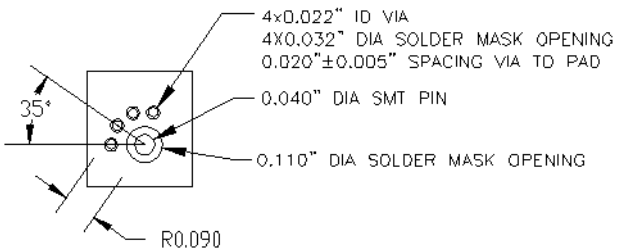
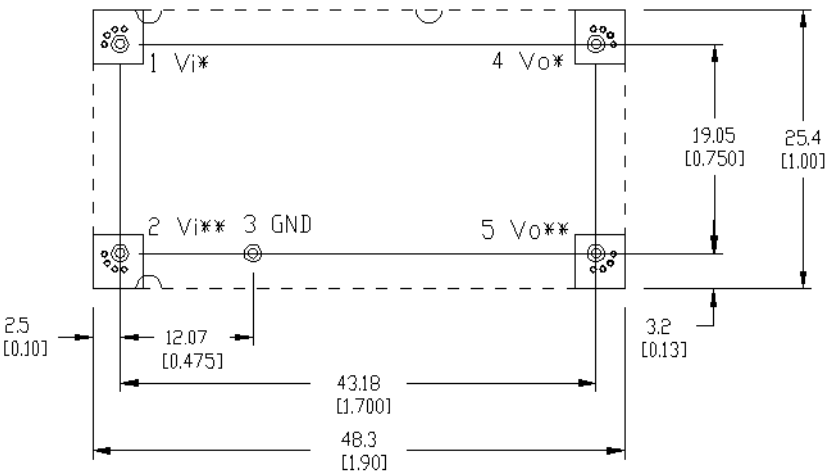

* - May be either + or – polarity, but must be same for pin 1 and 4.

** - Pin 2 and 5 shall be polarity that is opposite from pins 1 and 4.

FLT012A0Z/FLT012A0-SZ: Input Filter Modules

75Vdc Input Voltage Maximum; 12A Output Current Maximum

Ordering Information

Please contact your GE Sales Representative for pricing, availability and optional features.

Table 1. Device Codes

Device Code	Input Voltage Range	Output Current	Connector Type	Comcodes
FLT012A0Z	0 – 75Vdc	12A	TH	CC109172202
FLT012A0-SZ	0 – 75Vdc	12A	SMT	CC109172210
FLT012A0-11Z	0 – 75Vdc	12A	TH	150047449

-11 refers to Special option with withstand voltage of 2000Vdc

-Z refers to RoHS-compliant codes

Contact Us

For more information, call us at

USA/Canada:

+1 877 546 3243, or +1 972 244 9288

Asia-Pacific:

+86.021.54279977*808

Europe, Middle-East and Africa:

+49.89.878067-280

www.gecriticalpower.com



GE Critical Power reserves the right to make changes to the product(s) or information contained herein without notice, and no liability is assumed as a result of their use or application. No rights under any patent accompany the sale of any such product(s) or information.

Компания «Life Electronics» занимается поставками электронных компонентов импортного и отечественного производства от производителей и со складов крупных дистрибьюторов Европы, Америки и Азии.

С конца 2013 года компания активно расширяет линейку поставок компонентов по направлению коаксиальный кабель, кварцевые генераторы и конденсаторы (керамические, пленочные, электролитические), за счёт заключения дистрибьюторских договоров

Мы предлагаем:

- Конкурентоспособные цены и скидки постоянным клиентам.
- Специальные условия для постоянных клиентов.
- Подбор аналогов.
- Поставку компонентов в любых объемах, удовлетворяющих вашим потребностям.
- Приемлемые сроки поставки, возможна ускоренная поставка.
- Доставку товара в любую точку России и стран СНГ.
- Комплексную поставку.
- Работу по проектам и поставку образцов.
- Формирование склада под заказчика.
- Сертификаты соответствия на поставляемую продукцию (по желанию клиента).
- Тестирование поставляемой продукции.
- Поставку компонентов, требующих военную и космическую приемку.
- Входной контроль качества.
- Наличие сертификата ISO.

В составе нашей компании организован Конструкторский отдел, призванный помогать разработчикам, и инженерам.

Конструкторский отдел помогает осуществить:

- Регистрацию проекта у производителя компонентов.
- Техническую поддержку проекта.
- Защиту от снятия компонента с производства.
- Оценку стоимости проекта по компонентам.
- Изготовление тестовой платы монтаж и пусконаладочные работы.



Тел: +7 (812) 336 43 04 (многоканальный)

Email: org@lifeelectronics.ru