

LISA2-WW-CLIP

~45° wide beam optimized for CREE XP-E. 6.8 mm high variant with clip installation.

TECHNICAL SPECIFICATIONS:

Dimensions	Ø 9.9 mm
Height	6.8 mm
Fastening	glue, clips
ROHS compliant	yes ⓘ

MATERIAL SPECIFICATIONS:

Component	Type	Material	Colour	Finish
LISA2-WW	Single lens	PMMA	clear	
LISA2-HLD-CLIP16-XP	Holder	PC	black	



ORDERING INFORMATION:

Component		Qty in box	MOQ	MPQ	Box weight (kg)
FP13029_LISA2-WW-CLIP	Single lens	2000	300	100	1.4
» Box size:					

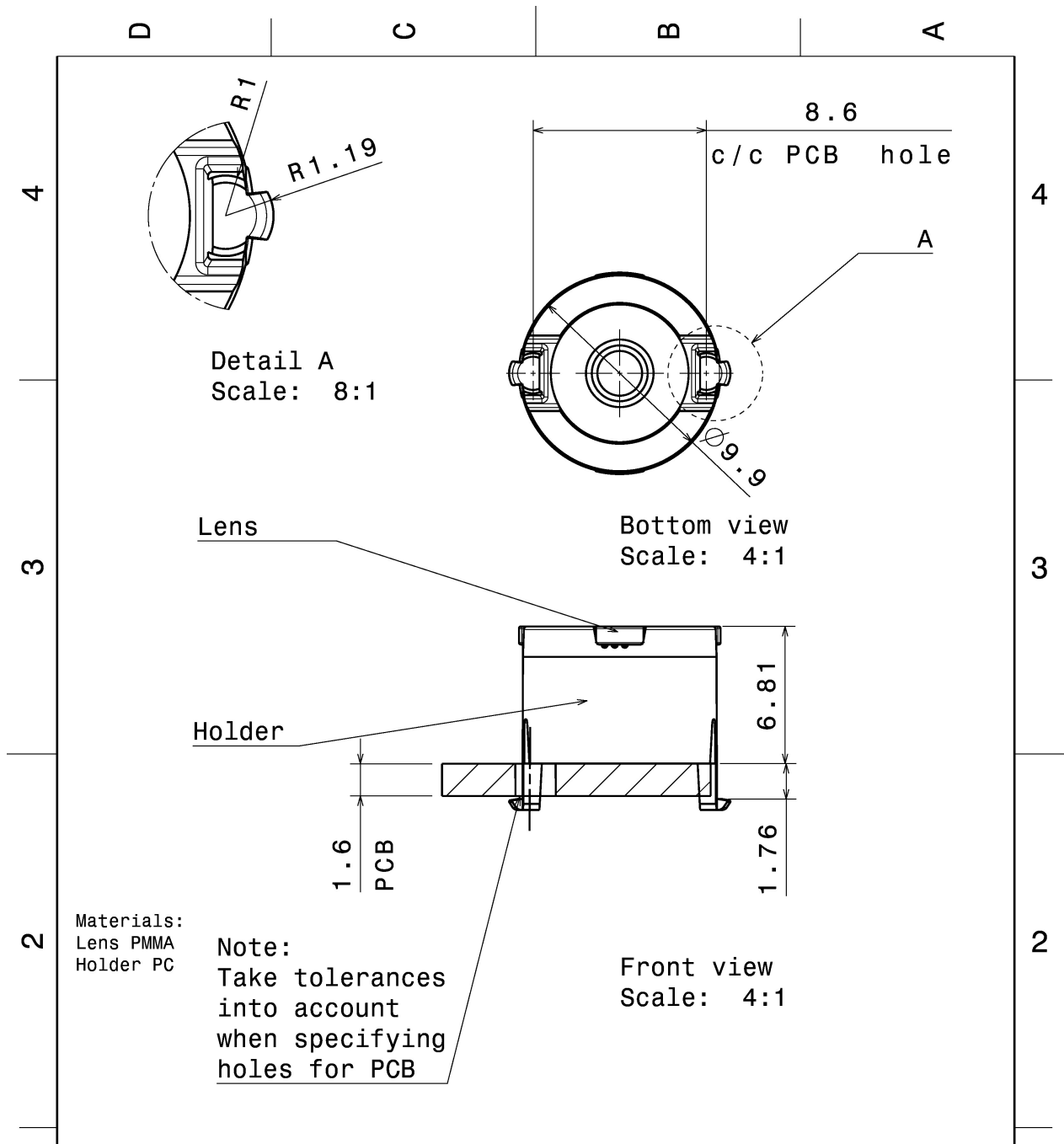

This drawing is our property. It can't be reproduced or communicated without our written agreement.		LEDiL		Ledil Oy Salorankatu 10 FIN-24240 SALO Finland	
DRAWING TITLE					
DRAWN BY pl		DATE 20.06.2012		Datasheet Lisa2-clip16-XT series Assy	
CHECKED BY sn	DATE 20.7.2011	SIZE A4	DRAWING NUMBER		REV 1
DESIGNED BY pl	DATE 20.06.2012	SCALE 4:1	WEIGHT (g)	SHEET 1/1	

PHOTOMETRIC DATA (MEASURED):

CREE

LED XP-E2
 FWHM 43.0°
 Efficiency 88 %
 Peak intensity 1.4 cd/lm
 LEDs/each optic 1
 Light colour White
 Required components:

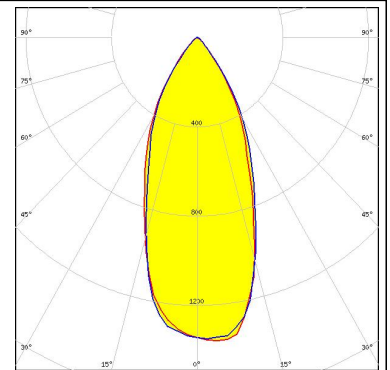
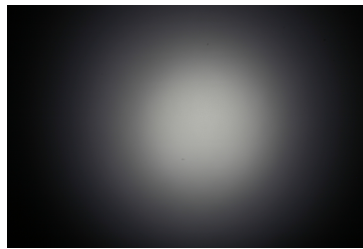

CREE

LED XP-G2
 FWHM 47.0°
 Efficiency 88 %
 Peak intensity 1.2 cd/lm
 LEDs/each optic 1
 Light colour White
 Required components:

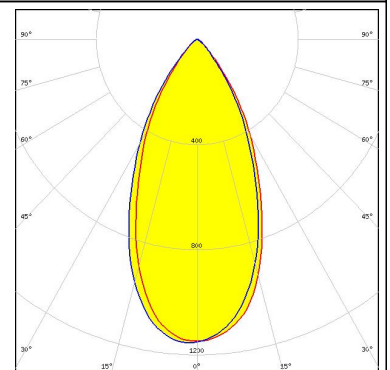

CREE

LED XP-G3
 FWHM 42.0°
 Efficiency 84 %
 Peak intensity 1.5 cd/lm
 LEDs/each optic 1
 Light colour White
 Required components:

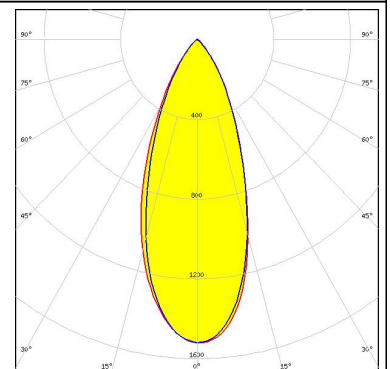
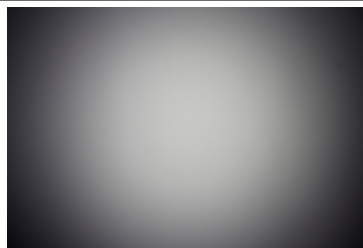



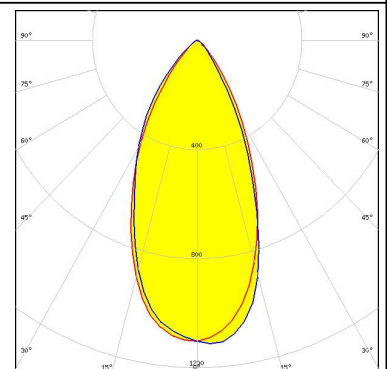

CREE

LED XT-E
 FWHM 47.0°
 Efficiency 84 %
 Peak intensity 1.1 cd/lm
 LEDs/each optic 1
 Light colour White
 Required components:

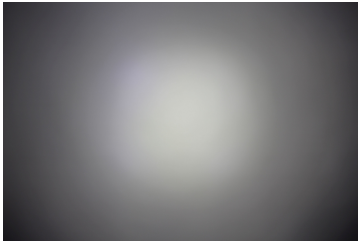
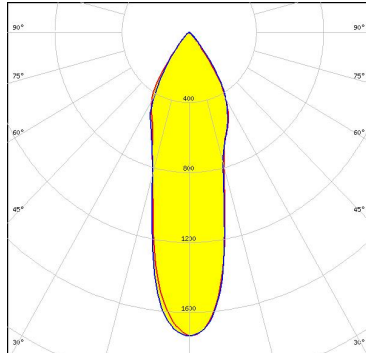
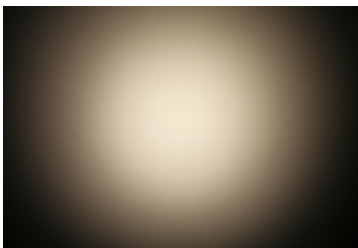
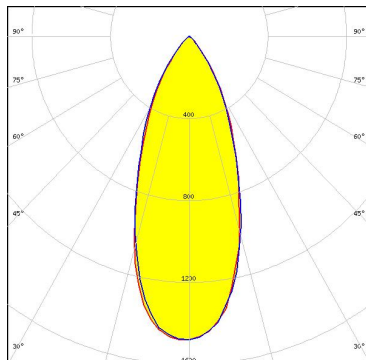

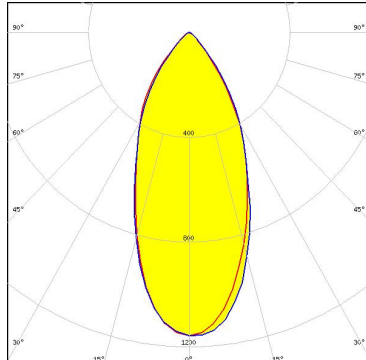
PHOTOMETRIC DATA (MEASURED):

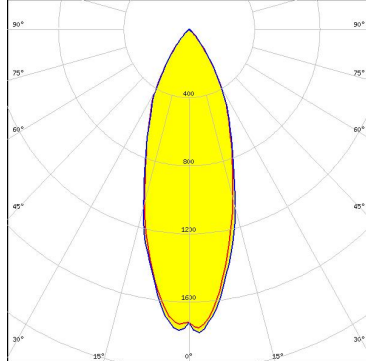
<p>LUMILEDS</p> <p>LED LUXEON CZ FWHM 29.0° Efficiency 86 % Peak intensity 1.7 cd/lm LEDs/each optic 1 Light colour White Required components:</p>		
<p>NICHIA</p> <p>LED NCSxx19B FWHM 41.0° Efficiency 86 % Peak intensity 1.5 cd/lm LEDs/each optic 1 Light colour White Required components:</p>		
<p>OSRAM <small>Opto Semiconductors</small></p> <p>LED OSOLON Square EC FWHM 46.0° Efficiency 84 % Peak intensity 1.6 cd/lm LEDs/each optic 1 Light colour White Required components:</p>		
<p>OSRAM <small>Opto Semiconductors</small></p> <p>LED SFH 4715S FWHM 36.0° Efficiency 0 % LEDs/each optic 1 Light colour White Required components:</p>		

PHOTOMETRIC DATA (MEASURED):

OSRAM
Opto Semiconductors

LED SFH 4725S
FWHM 38.0°
Efficiency %
LEDs/each optic 1
Light colour White
Required components:

SAMSUNG

LED LH351B
FWHM 67.0°
Efficiency 88 %
Peak intensity 0.9 cd/lm
LEDs/each optic 1
Light colour White
Required components:

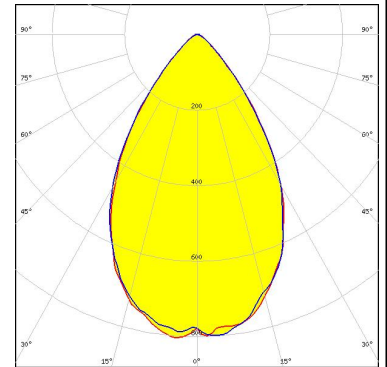
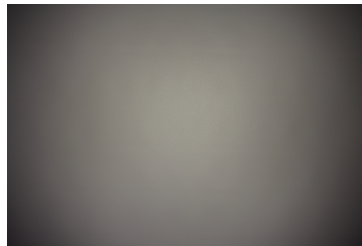

SAMSUNG

LED LH351Z
FWHM 60.0°
Efficiency 90 %
Peak intensity 1 cd/lm
LEDs/each optic 1
Light colour White
Required components:

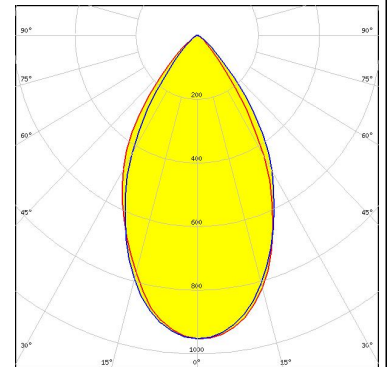
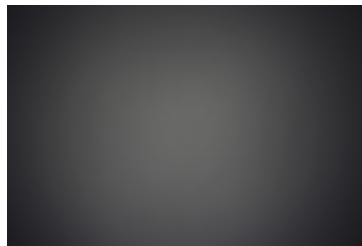

PHOTOMETRIC DATA (SIMULATED):



LED XP-G2 HE
FWHM 69.0°
Efficiency 88 %
Peak intensity 0.7 cd/lm
LEDs/each optic 1
Light colour White
Required components:

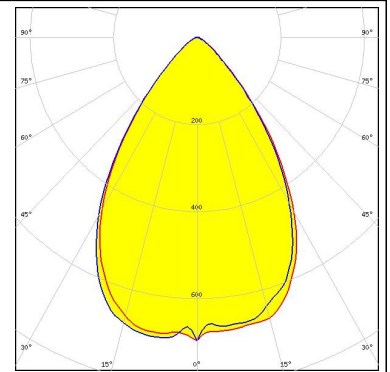

LED LUXEON IR Compact
FWHM 51.0°
Efficiency 84 %
LEDs/each optic 1
Light colour White
Required components:



LED LUXEON IR Domed 150
FWHM 60.0°
Efficiency 90 %
LEDs/each optic 1
Light colour White
Required components:



LED LUXEON Q
FWHM 54.0°
Efficiency 84 %
Peak intensity 1 cd/lm
LEDs/each optic 1
Light colour White
Required components:

PHOTOMETRIC DATA (SIMULATED):

OSRAM
Opto Semiconductors

LED SFH 4770S
FWHM 35.0°
Efficiency 91 %
LEDs/each optic 1
Light colour White
Required components:

SEOL
SEOUL SEMICONDUCTOR

LED Z8Y22P
FWHM 50.0°
Efficiency 86 %
Peak intensity 1.1 cd/lm
LEDs/each optic 1
Light colour White
Required components:

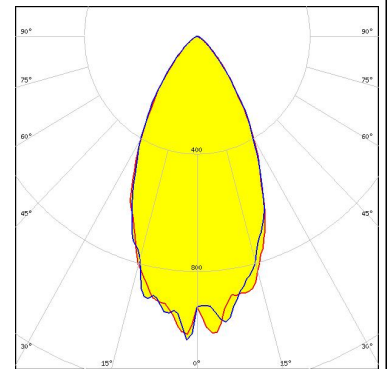

GENERAL INFORMATION:

NOTE: The typical beam angle will be changed by different color, chip size and chip position tolerance. The typical total beam angle is the full angle measured where the luminous intensity is half of the peak value.

MATERIALS:

As part of our continuous research and improvement processes, and to ensure the best possible quality and availability of our products, LEDiL reserves the right to change material grades without notice.

PRODUCT DATA USER AGREEMENT AND DISCLAIMER:

The measured data in the provided downloadable LEDiL Product Datasheets and Mechanical 2D-Drawings is rounded and provided as reference for planning. LEDiL Oy's optical specifications have been verified by conducting performance testing of the products in accordance with the company's quality system. The reported data are averaged results of multiple measurements with typical variation. LEDiL Oy reserves the right to without prior notification make changes and improvements to its products.

LEDiL Oy assumes neither warranty, nor guarantee nor any other liability of any kind for the contents and correctness of the provided data. The provided data has been generated with highest diligence but the provided data may in reality not represent the complete possible variation range of all intrinsic parameters. Therefore, in certain cases a deviation from the provided data could occur.

LEDiL Oy reserves the right to undertake technical changes of its products without further notification which could lead to changes in the provided data. LEDiL Oy assumes no liability of any kind for the possible deviation from any provided data or any other damage resulting from the usage of the provided data.

The user agrees to this disclaimer and user agreement with the download or usage of the provided files.

LEDiL Oy

Joensuunkatu 13
FI-24240 SALO
Finland

LEDiL Inc.

228 West Page Street
Suite D
Sycamore IL 60178
USA

Local sales and technical support

[www.ledil.com/
where_to_buy](http://www.ledil.com/where_to_buy)

Shipping locations

Salo, Finland
Hong Kong, China

Distribution Partners

[www.ledil.com/
where_to_buy](http://www.ledil.com/where_to_buy)

Компания «Life Electronics» занимается поставками электронных компонентов импортного и отечественного производства от производителей и со складов крупных дистрибьюторов Европы, Америки и Азии.

С конца 2013 года компания активно расширяет линейку поставок компонентов по направлению коаксиальный кабель, кварцевые генераторы и конденсаторы (керамические, пленочные, электролитические), за счёт заключения дистрибьюторских договоров

Мы предлагаем:

- Конкуренспособные цены и скидки постоянным клиентам.
- Специальные условия для постоянных клиентов.
- Подбор аналогов.
- Поставку компонентов в любых объемах, удовлетворяющих вашим потребностям.
- Приемлемые сроки поставки, возможна ускоренная поставка.
- Доставку товара в любую точку России и стран СНГ.
- Комплексную поставку.
- Работу по проектам и поставку образцов.
- Формирование склада под заказчика.
- Сертификаты соответствия на поставляемую продукцию (по желанию клиента).
- Тестирование поставляемой продукции.
- Поставку компонентов, требующих военную и космическую приемку.
- Входной контроль качества.
- Наличие сертификата ISO.

В составе нашей компании организован Конструкторский отдел, призванный помогать разработчикам, и инженерам.

Конструкторский отдел помогает осуществить:

- Регистрацию проекта у производителя компонентов.
- Техническую поддержку проекта.
- Защиту от снятия компонента с производства.
- Оценку стоимости проекта по компонентам.
- Изготовление тестовой платы монтаж и пусконаладочные работы.



Тел: +7 (812) 336 43 04 (многоканальный)

Email: org@lifeelectronics.ru