

ITEM	Q'TY	PART NUMBER	PART DESCRIPTION
1	1	H-278C-2	T-1¼ (5mm) Bi-Level LED Holder, 90° Mount
2	2	5XX	T-1¼ (5mm) Non-Flange LED, See Following Pages

REV.	DESCRIPTION	DATE	APPROVED
C	Corrected Holder from H-278C to H-278C-1.	02/28/05	M. C.
D	Changed Holder from H-278C-1 to H-278C-2.	02/14/07	M. C.
E	Changed LED Protrusion from .180 to .170	02/27/07	M. C.
F	Added P/N Designation Note	03/04/09	T. Y.
G	Added H278CGAD	05/29/12	T. Y.
H	Updated LED Offering List	06/19/12	T. Y.
J	Updated LED Optical Characteristics	09/15/15	J. C.

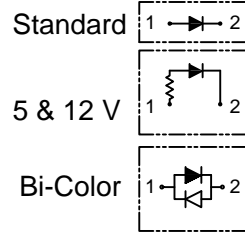
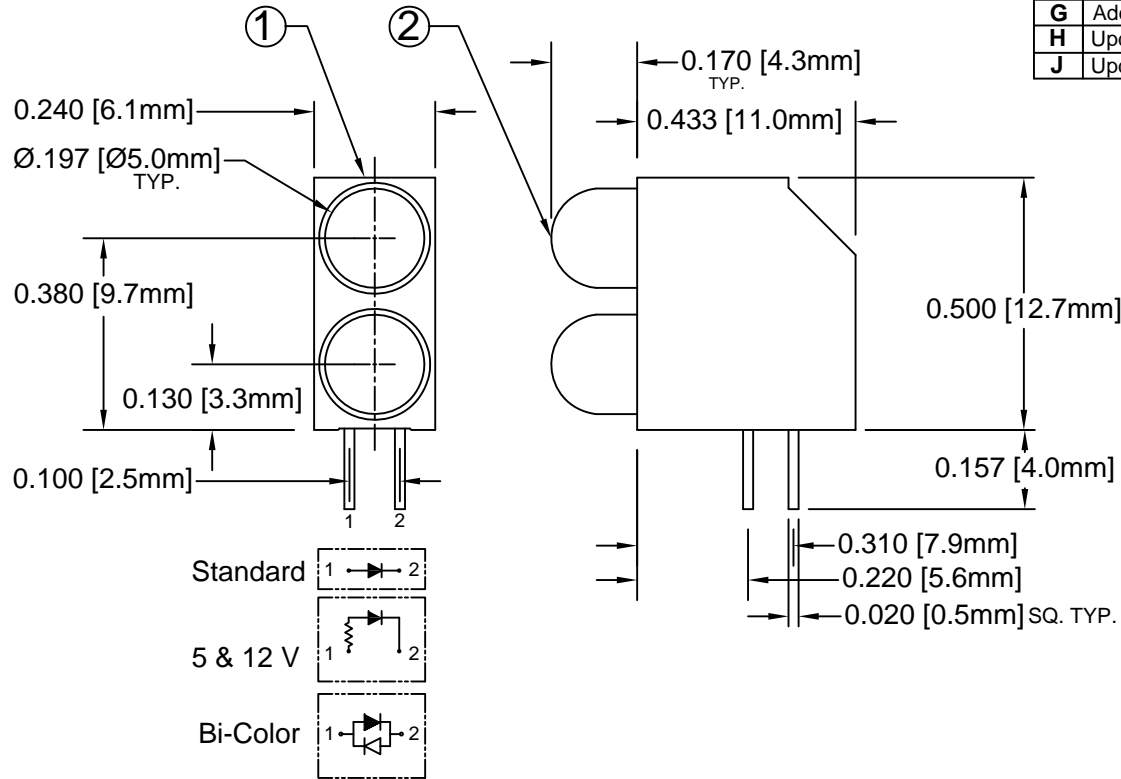

BI-COLOR POLARITY		
LED P/N	(1) Cathode	(2) Cathode
5BC	Green	Red
5BC-Y/G	Green	Yellow
5BC-R/Y	Yellow	Red
5BC-A/G	Green	Amber

NOTE: P/N CONFIGURATION

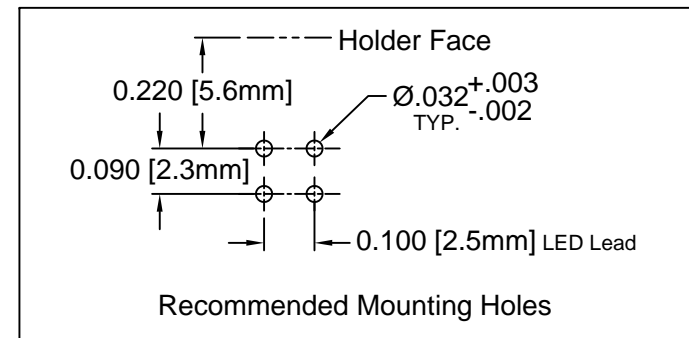
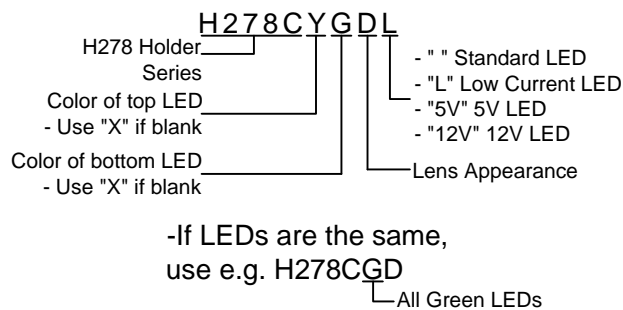

ABSOLUTE MAXIMUM RATINGS (Ta=25° C)

REVERSE VOLTAGE _____	5V
REVERSE CURRENT _____	100uA
OPERATING TEMPERATURE RANGE _____	-25° C - 85° C
STORAGE TEMPERATURE _____	-30° C - 100° C
LEAD SOLDERING TEMPERATURE(1/16" FROM BODY) _____	260° C FOR 5 SECONDS

STANDARD TOLERANCE (UNLESS OTHERWISE SPECIFIED)		 4 THOMAS, IRVINE, CA. 92618 TEL: (949) 951-8808 FAX: (949) 951-3974			
DECIMALS	ANGULAR				
.X ± .1	X° ± 1°	TITLE: T-1¼ (5MM) 90° BI-LEVEL LED ASSY			
.XX ± .02					
.XXX ± .010		DESIGNED: T. Yin CHECKED: D. Green	DATE: 03/05/04 DATE: 03/05/04	PART NO: H278CXX CAGE CODE : 32559	REVISION: J SHEET # 1 OF 4
CAD GENERATED DOCUMENT. DO NOT MEASURE DRAWING.					

REV.	DESCRIPTION	DATE	APPROVED
	SEE SHEET#1.		

LED Assy. No.	Chip			Lens Appearance	Electro-Optical Data @ 20mA				Viewing Angle 2 θ ½ (Deg)	LED P/N	
	Material	Peak Wave Length	Emitted Color		If (mA)	Vf (V)		Iv (mcd)			
						MAX	TYP	MAX			TYP
H278CBWC	GaN/SiC	430	BLUE	WATER CLEAR	25	4.0	4.5	25	20	5BWC	
H278CBWD	GaN/SiC	430	BLUE	DIFFUSED	25	4.0	4.5	15	45	5BWD	
H278CBWT	GaN/SiC	430	BLUE	TINTED	25	4.0	4.5	30	20	5BWT	
H278CGC	GaP/GaP	568	GREEN	WATER CLEAR	30	2.1	2.8	40	35	5GC	
H278CGD	GaP/GaP	568	GREEN	DIFFUSED	30	2.1	2.8	25	45	5GD	
H278CGT	GaP/GaP	568	GREEN	TINTED	30	2.1	2.8	40	35	5GT	
H278CUGC	AlGaInP	570	GREEN	WATER CLEAR	30	2.1	2.4	600	35	5UGC	
H278CPGC	GaP/GaP	555	PURE GREEN	WATER CLEAR	30	2.2	2.8	10	35	5PGC	
H278CPGD	GaP/GaP	555	PURE GREEN	DIFFUSED	30	2.2	2.8	10	45	5PGD	
H278CPGT	GaP/GaP	555	PURE GREEN	TINTED	30	2.2	2.8	10	35	5PGT	
H278CYC	GaAsP/GaP	590	YELLOW	WATER CLEAR	30	2.0	2.8	40	35	5YC	
H278CYD	GaAsP/GaP	590	YELLOW	DIFFUSED	30	2.0	2.8	25	45	5YD	
H278CYT	GaAsP/GaP	590	YELLOW	TINTED	30	2.0	2.8	40	35	5YT	
H278CAC	GaAsP/GaP	605	AMBER	WATER CLEAR	30	2.0	2.8	40	35	5AC	
H278CAD	GaAsP/GaP	605	AMBER	DIFFUSED	30	2.0	2.8	25	45	5AD	
H278CAT	GaAsP/GaP	605	AMBER	TINTED	30	2.0	2.8	40	35	5AT	
H278CHC	GaAsP/GaP	625	HE RED	WATER CLEAR	30	2.0	2.8	40	35	5HC	
H278CHD	GaAsP/GaP	625	HE RED	DIFFUSED	30	2.0	2.8	25	45	5HD	
H278CHT	GaAsP/GaP	625	HE RED	TINTED	30	2.0	2.8	40	35	5HT	
H278CRC	GaP/GaP	700	RED	WATER CLEAR	20	2.1	2.8	2	35	5RC	
H278CRD	GaP/GaP	700	RED	DIFFUSED	20	2.1	2.8	2	45	5RD	
H278CRT	GaP/GaP	700	RED	TINTED	20	2.1	2.8	2	35	5RT	
H278CBC-A/G	GaAsP/GaP	605	AMBER	WHITE DIFFUSED	30	2.0	2.8	6	45	5BC-A/G	
	GaP/GaP	568	GREEN		30	2.1	2.8	6			
H278CBC	GaAsP/GaP	625	RED	WHITE DIFFUSED	30	2.0	2.8	6	45	5BC	
	GaP/GaP	568	GREEN		30	2.1	2.8	8			
H278CBC-R/Y	GaAsP/GaP	625	RED	WHITE DIFFUSED	30	2.0	2.8	6	45	5BC-R/Y	
	GaAsP/GaP	590	YELLOW		30	2.0	2.8	5			
H278CBC-Y/G	GaAsP/GaP	590	YELLOW	WHITE DIFFUSED	30	2.0	2.8	5	45	5BC-Y/G	
	GaP/GaP	568	GREEN		30	2.1	2.8	8			

STANDARD TOLERANCE (UNLESS OTHERWISE SPECIFIED) ±10% ALL VALUES		ANGULAR X° ± 5°		 BIVAR [®] 4 THOMAS, IRVINE, CA. 92618 TEL: (949) 951-8808 FAX: (949) 951-3974	
DESIGNED: T. Yin		DATE: 03/05/04			
CHECKED: D. Green		DATE: 03/05/04		PART NO: H278CXX	
				REVISION: J	
				CAGE CODE : 32559 SHEET # 2 OF 4	
CAD GENERATED DOCUMENT. DO NOT MEASURE DRAWING.					

REV.	DESCRIPTION	DATE	APPROVED
	SEE SHEET#1.		

LED Assy. No.	Chip			Lens Appearance	Electro-Optical Data @ 20mA				Viewing Angle 2 θ ½ (Deg)	LED P/N
	Material	Peak Wave Length	Emitted Color		If (mA)	Vf (V)		Iv (mcd)		
						MAX	TYP			
H278CUBWC	InGaN/SiC	468	BLUE	WATER CLEAR	50	3.2	3.6	5000	15	5BWC2.515
H278CSGC	GaP/GaP	568	GREEN	WATER CLEAR	30	2.1	2.8	60	35	5SGC
H278CSGD	GaP/GaP	568	GREEN	DIFFUSED	30	2.1	2.8	50	45	5SGD
H278CSGT	GaP/GaP	568	GREEN	TINTED	30	2.1	2.8	60	35	5SGT
H278CSYC	GaAsP/GaP	590	YELLOW	WATER CLEAR	30	2.0	2.8	600	35	5SYC
H278CSYD	GaAsP/GaP	590	YELLOW	DIFFUSED	30	2.0	2.8	150	45	5SYD
H278CSYT	GaAsP/GaP	590	YELLOW	TINTED	30	2.0	2.8	600	35	5SYT
H278CSRC	GaAlAs/GaAs	645	SUPER RED	WATER CLEAR	30	1.7	2.4	60	35	5SRC
H278CSRD	GaAlAs/GaAs	645	SUPER RED	DIFFUSED	30	1.7	2.4	40	45	5SRD
H278CSRT	GaAlAs/GaAs	645	SUPER RED	TINTED	30	1.7	2.4	60	35	5SRT
H278CUGC	AlGaInP	570	GREEN	WATER CLEAR	30	2.1	2.4	400	35	5UGC
H278CSUGC	AlGaInP	570	GREEN	WATER CLEAR	30	2.1	2.4	300	35	5SUGC
H278CUYC	AlGaInP	590	YELLOW	WATER CLEAR	30	2.0	2.4	1000	30	5UYC
H278CSUYC	AlGaInP	590	YELLOW	WATER CLEAR	30	2.0	2.4	700	35	5SUYC
H278CUUYC	AlGaInP	590	YELLOW	WATER CLEAR	30	2.0	2.4	500	35	5UUYC
H278CUOC	AlGaInP	625	ORANGE	WATER CLEAR	30	1.8	2.4	1400	35	5UOC
H278CUOC	AlGaInP	625	ORANGE	WATER CLEAR	30	1.8	2.4	1300	35	5SUOC
H278CURC	GaAlAs/GaAs	645	RED	WATER CLEAR	30	1.7	2.4	400	30	5URC
H278CSURC	AlGaInP	640	RED	WATER CLEAR	30	1.8	2.4	500	35	5SURC
H278CUWC	InGaN/SiC	6500K	WHITE	WATER CLEAR	100	3.5	4.2	2700	30	5WC2.730

STANDARD TOLERANCE (UNLESS OTHERWISE SPECIFIED) ±10% ALL VALUES		 BIVAR [®] 4 THOMAS, IRVINE, CA. 92618 TEL: (949) 951-8808 FAX: (949) 951-3974	
ANGULAR X° ± 5°			
DESIGNED: T. Yin		DATE: 03/05/04	TITLE: T-1¼ (5MM) 90° BI-LEVEL LED ASSY
CHECKED: D. Green		DATE: 03/05/04	PART NO: H278CXX REVISION: J
		CAGE CODE : 32559	SHEET # 3 OF 4
CAD GENERATED DOCUMENT. DO NOT MEASURE DRAWING.			

REV.	DESCRIPTION	DATE	APPROVED
	SEE SHEET#1.		

LED Assy. No.	Peak Wave Length λ_p (nm)	Emitted Color	Lens Appearance	Max. Rating	Electro-Optical Data @ 2mA			Viewing Angle 2 θ 1/2 (Deg)	LED P/N
				If (mA)	Vf (V)		Iv (mcd)		
				MAX	TYP	MAX	TYP		
H278CBWDL	430	BLUE	DIFFUSED	7	3.8	4.2	4	45	5BWDL
H278CPGDL	555	PURE GREEN	DIFFUSED	7	2.1	2.6	1	45	5PGDL
H278CGDL	568	GREEN	DIFFUSED	7	2.1	2.6	4	45	5GDL
H278CYDL	590	YELLOW	DIFFUSED	7	2.0	2.6	4	45	5YDL
H278CADL	605	AMBER	DIFFUSED	7	2.0	2.6	4	45	5ADL
H278CHDL	625	HE RED	DIFFUSED	7	2.0	2.6	5	45	5HDL
H278CSRDL	645	SUPER RED	DIFFUSED	7	1.7	2.3	6	45	5SRDL

LED Assy. No.	Peak Wave Length λ_p (nm)	Emitted Color	Lens Appearance	Electro-Optical Data				Viewing Angle 2 θ 1/2 (Deg)	LED P/N
				If (mA)	Vf (V)		Iv (mcd)		
				MAX	TYP	MAX	TYP		
5 Volt				Data @ 5V					
H278CBWD5V	BLUE	430	DIFFUSED	-	-	5	15	45	5BWD5V
H278CGC5V	GREEN	568	WATER CLEAR	-	-	5	40	35	5GC5V
H278CGD5V	GREEN	568	DIFFUSED	-	-	5	25	45	5GD5V
H278CGT5V	GREEN	568	TINTED	-	-	5	40	35	5GT5V
H278CAD5V	AMBER	605	DIFFUSED	-	-	5	25	45	5AD5V
H278CHD5V	HE RED	625	DIFFUSED	-	-	5	30	45	5HD5V
H278CRD5V	RED	700	DIFFUSED	-	-	5	1.5	45	5RD5V
H278CYD5V	YELLOW	590	DIFFUSED	-	-	5	25	45	5YD5V
12 Volt				Data @ 12V					
H278CGC12V	GREEN	568	WATER CLEAR	-	-	12	40	35	5GC12V
H278CGD12V	GREEN	568	DIFFUSED	-	-	12	25	45	5GD12V
H278CHC12V	HE RED	625	WATER CLEAR	-	-	12	50	35	5HC12V
H278CHD12V	HE RED	625	DIFFUSED	-	-	12	30	45	5HD12V
H278CRC12V	RED	700	WATER CLEAR	-	-	12	2	35	5RC12V
H278CRD12V	RED	700	DIFFUSED	-	-	12	1.5	45	5RD12V
H278CYC12V	YELLOW	590	WATER CLEAR	-	-	12	25	35	5YC12V
H278CYD12V	YELLOW	590	DIFFUSED	-	-	12	20	45	5YD12V

STANDARD TOLERANCE (UNLESS OTHERWISE SPECIFIED) $\pm 10\%$ ALL VALUES		ANGULAR X° \pm 5°		 BIVAR [®] 4 THOMAS, IRVINE, CA. 92618 TEL: (949) 951-8808 FAX: (949) 951-3974
DESIGNED: T. Yin		DATE: 03/05/04		
CHECKED: D. Green		DATE: 03/05/04		PART NO: H278CXX
				REVISION: J
				CAGE CODE : 32559 SHEET # 4 OF 4
CAD GENERATED DOCUMENT. DO NOT MEASURE DRAWING.				

Компания «Life Electronics» занимается поставками электронных компонентов импортного и отечественного производства от производителей и со складов крупных дистрибьюторов Европы, Америки и Азии.

С конца 2013 года компания активно расширяет линейку поставок компонентов по направлению коаксиальный кабель, кварцевые генераторы и конденсаторы (керамические, пленочные, электролитические), за счёт заключения дистрибьюторских договоров

Мы предлагаем:

- Конкурентоспособные цены и скидки постоянным клиентам.
- Специальные условия для постоянных клиентов.
- Подбор аналогов.
- Поставку компонентов в любых объемах, удовлетворяющих вашим потребностям.
- Приемлемые сроки поставки, возможна ускоренная поставка.
- Доставку товара в любую точку России и стран СНГ.
- Комплексную поставку.
- Работу по проектам и поставку образцов.
- Формирование склада под заказчика.
- Сертификаты соответствия на поставляемую продукцию (по желанию клиента).
- Тестирование поставляемой продукции.
- Поставку компонентов, требующих военную и космическую приемку.
- Входной контроль качества.
- Наличие сертификата ISO.

В составе нашей компании организован Конструкторский отдел, призванный помогать разработчикам, и инженерам.

Конструкторский отдел помогает осуществить:

- Регистрацию проекта у производителя компонентов.
- Техническую поддержку проекта.
- Защиту от снятия компонента с производства.
- Оценку стоимости проекта по компонентам.
- Изготовление тестовой платы монтаж и пусконаладочные работы.



Тел: +7 (812) 336 43 04 (многоканальный)

Email: org@lifeelectronics.ru