





| ABSOLUTE MAXIMUM RATINGS (T <sub>amb</sub> = 25 °C, unless otherwise specified) |  |                   |                    |                  |
|---|--|-------------------|--------------------|------------------|
| PARAMETER   | TEST CONDITION                                     | SYMBOL            | VALUE              | UNIT             |
| <b>INPUT</b>  |  |                   |                    |                  |
| Reverse voltage   |  | V <sub>R</sub>    | 6                  | V                |
| DC forward current  |  | I <sub>F</sub>    | 60                 | mA               |
| Forward surge current   | t <sub>p</sub> ≤ 10 μs                             | I <sub>FSM</sub>  | 2.5                | A                |
| LED power dissipation   | at 25 °C   | P <sub>diss</sub> | 70                 | mW               |
| <b>OUTPUT</b>   |  |                   |                    |                  |
| Collector emitter voltage   |  | V <sub>CEO</sub>  | 70                 | V                |
| Emitter collector voltage   |  | V <sub>ECO</sub>  | 7                  | V                |
| Collector current   |  | I <sub>C</sub>    | 50                 | mA               |
| Collector peak current  | t <sub>p</sub> /T = 0.5, t <sub>p</sub> ≤ 10 ms    | I <sub>CM</sub>   | 100                | mA               |
| Output power dissipation  | at 25 °C   | P <sub>diss</sub> | 150                | mW               |
| <b>COUPLER</b>  |  |                   |                    |                  |
| Isolation test voltage between emitter and detector                             | t = 1 s  | V <sub>ISO</sub>  | 5300               | V <sub>RMS</sub> |
| Creepage distance   |  |                   | ≥ 7                | mm               |
| Clearance distance  |  |                   | ≥ 7                | mm               |
| Isolation thickness between emitter and detector                                |  |                   | ≥ 0.4              | mm               |
| Comparative tracking index per DIN IEC 112/VDE 0303, part 1                     |  | CTI               | ≥ 175              |                  |
| Isolation resistance  | V <sub>IO</sub> = 500 V, T <sub>amb</sub> = 25 °C  | R <sub>IO</sub>   | ≥ 10 <sup>12</sup> | Ω                |
|   | V <sub>IO</sub> = 500 V, T <sub>amb</sub> = 100 °C | R <sub>IO</sub>   | ≥ 10 <sup>11</sup> | Ω                |
| Operation temperature   |  | T <sub>amb</sub>  | -55 to +100        | °C               |
| Storage temperature range   |  | T <sub>stg</sub>  | -55 to +150        | °C               |
| Soldering temperature <sup>(1)</sup>  | 2 mm from case, ≤ 10 s                             | T <sub>slid</sub> | 260                | °C               |

**Notes**

- Stresses in excess of the absolute maximum ratings can cause permanent damage to the device. Functional operation of the device is not implied at these or any other conditions in excess of those given in the operational sections of this document. Exposure to absolute maximum ratings for extended periods of the time can adversely affect reliability.

<sup>(1)</sup> Refer to reflow profile for soldering conditions for surface mounted devices (SMD). Refer to wave profile for soldering conditions for through hole devices (DIP).

| ELECTRICAL CHARACTERISTICS (T <sub>amb</sub> = 25 °C, unless otherwise specified) |                                   |           |                    |      |      |      |      |
|---|-----------------------------------|-----------|--------------------|------|------|------|------|
| PARAMETER   | TEST CONDITION                    | PART      | SYMBOL             | MIN. | TYP. | MAX. | UNIT |
| <b>INPUT</b>  |                                   |           |                    |      |      |      |      |
| Forward voltage   | I <sub>F</sub> = 60 mA            |           | V <sub>F</sub>     |      | 1.35 | 1.65 | V    |
| Reverse current   | V <sub>R</sub> = 6 V              |           | I <sub>R</sub>     |      | 0.01 | 10   | μA   |
| Capacitance   | V <sub>R</sub> = 0 V, f = 1 MHz   |           | C <sub>O</sub>     |      | 13   |      | pF   |
| <b>OUTPUT</b>   |                                   |           |                    |      |      |      |      |
| Collector emitter capacitance   | V <sub>CE</sub> = 5 V, f = 1 MHz  |           | C <sub>CE</sub>    |      | 5.2  |      | pF   |
| Collector emitter leakage current   | V <sub>CE</sub> = 10 V            | SFH615A-1 | I <sub>CEO</sub>   |      | 2    | 50   | nA   |
|   |                                   | SFH615A-2 | I <sub>CEO</sub>   |      | 2    | 50   | nA   |
|   |                                   | SFH615A-3 | I <sub>CEO</sub>   |      | 5    | 100  | nA   |
|   |                                   | SFH615A-4 | I <sub>CEO</sub>   |      | 5    | 100  | nA   |
| <b>COUPLER</b>  |                                   |           |                    |      |      |      |      |
| Collector emitter saturation voltage  | I <sub>F</sub> = 10 mA, f = 1 MHz |           | V <sub>CEsat</sub> |      | 0.25 | 0.4  | V    |
| Coupling capacitance  |                                   |           | C <sub>C</sub>     |      | 0.4  |      | pF   |

**Note**

- Minimum and maximum values are testing requirements. Typical values are characteristics of the device and are the result of engineering evaluation. Typical values are for information only and are not part of the testing requirements.



| <b>CURRENT TRANSFER RATIO</b> ( $T_{amb} = 25\text{ }^{\circ}\text{C}$ , unless otherwise specified) |  |           |        |      |      |      |      |
|--|--|-----------|--------|------|------|------|------|
| PARAMETER  | TEST CONDITION                               | PART      | SYMBOL | MIN. | TYP. | MAX. | UNIT |
| $I_C/I_F$  | $I_F = 10\text{ mA}$ , $V_{CE} = 5\text{ V}$ | SFH615A-1 | CTR    | 40   |      | 80   | %    |
|  |  | SFH615A-2 | CTR    | 63   |      | 125  | %    |
|  |  | SFH615A-3 | CTR    | 100  |      | 200  | %    |
|  |  | SFH615A-4 | CTR    | 160  |      | 320  | %    |
|  | $I_F = 1\text{ mA}$ , $V_{CE} = 5\text{ V}$  | SFH615A-1 | CTR    | 13   | 30   |      | %    |
|  |  | SFH615A-2 | CTR    | 22   | 45   |      | %    |
|  |  | SFH615A-3 | CTR    | 34   | 70   |      | %    |
|  |  | SFH615A-4 | CTR    | 56   | 90   |      | %    |

| <b>SWITCHING CHARACTERISTICS</b> ( $T_{amb} = 25\text{ }^{\circ}\text{C}$ , unless otherwise specified) |   |           |           |      |      |      |               |
|---|---|-----------|-----------|------|------|------|---------------|
| PARAMETER   | TEST CONDITION  | PART      | SYMBOL    | MIN. | TYP. | MAX. | UNIT          |
| <b>NON-SATURATED</b>  |   |           |           |      |      |      |               |
| Turn-on time  | $I_F = 10\text{ mA}$ , $V_{CC} = 5\text{ V}$ , $R_L = 75\text{ }\Omega$ |           | $t_{on}$  |      | 3    |      | $\mu\text{s}$ |
| Rise time   | $I_F = 10\text{ mA}$ , $V_{CC} = 5\text{ V}$ , $R_L = 75\text{ }\Omega$ |           | $t_r$     |      | 2    |      | $\mu\text{s}$ |
| Turn-off time   | $I_F = 10\text{ mA}$ , $V_{CC} = 5\text{ V}$ , $R_L = 75\text{ }\Omega$ |           | $t_{off}$ |      | 2.3  |      | $\mu\text{s}$ |
| Fall time   | $I_F = 10\text{ mA}$ , $V_{CC} = 5\text{ V}$ , $R_L = 75\text{ }\Omega$ |           | $t_f$     |      | 2    |      | $\mu\text{s}$ |
| Cut-off frequency   | $I_F = 10\text{ mA}$ , $V_{CC} = 5\text{ V}$ , $R_L = 75\text{ }\Omega$ |           | $f_{CO}$  |      | 100  |      | kHz           |
| <b>SATURATED</b>  |   |           |           |      |      |      |               |
| Turn-on time  | $I_F = 20\text{ mA}$  | SFH615A-1 | $t_{on}$  |      | 3    |      | $\mu\text{s}$ |
|   | $I_F = 10\text{ mA}$  | SFH615A-2 | $t_{on}$  |      | 4.2  |      | $\mu\text{s}$ |
|   |   | SFH615A-3 | $t_{on}$  |      | 4.2  |      | $\mu\text{s}$ |
|   | $I_F = 5\text{ mA}$   | SFH615A-4 | $t_{on}$  |      | 6    |      | $\mu\text{s}$ |
| Rise time   | $I_F = 20\text{ mA}$  | SFH615A-1 | $t_r$     |      | 2    |      | $\mu\text{s}$ |
|   | $I_F = 10\text{ mA}$  | SFH615A-2 | $t_r$     |      | 3    |      | $\mu\text{s}$ |
|   |   | SFH615A-3 | $t_r$     |      | 3    |      | $\mu\text{s}$ |
|   | $I_F = 5\text{ mA}$   | SFH615A-4 | $t_r$     |      | 4    |      | $\mu\text{s}$ |
| Turn-off time   | $I_F = 20\text{ mA}$  | SFH615A-1 | $t_{off}$ |      | 18   |      | $\mu\text{s}$ |
|   | $I_F = 10\text{ mA}$  | SFH615A-2 | $t_{off}$ |      | 23   |      | $\mu\text{s}$ |
|   |   | SFH615A-3 | $t_{off}$ |      | 23   |      | $\mu\text{s}$ |
|   | $I_F = 5\text{ mA}$   | SFH615A-4 | $t_{off}$ |      | 25   |      | $\mu\text{s}$ |
| Fall time   | $I_F = 20\text{ mA}$  | SFH615A-1 | $t_f$     |      | 11   |      | $\mu\text{s}$ |
|   | $I_F = 10\text{ mA}$  | SFH615A-2 | $t_f$     |      | 14   |      | $\mu\text{s}$ |
|   |   | SFH615A-3 | $t_f$     |      | 14   |      | $\mu\text{s}$ |
|   | $I_F = 5\text{ mA}$   | SFH615A-4 | $t_f$     |      | 15   |      | $\mu\text{s}$ |



95 10804-3

Fig. 1 - Test Circuit, Non-Saturated Operation

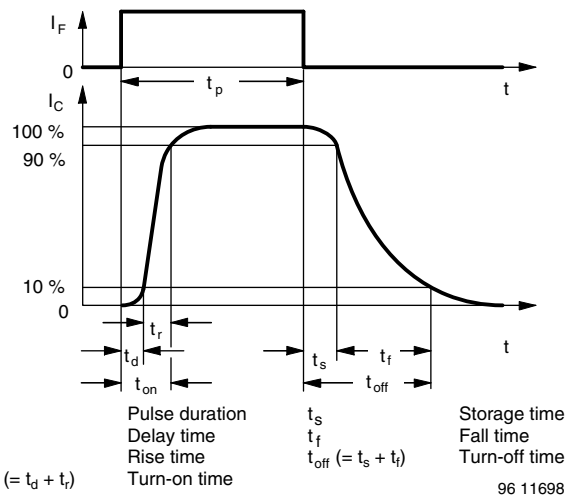
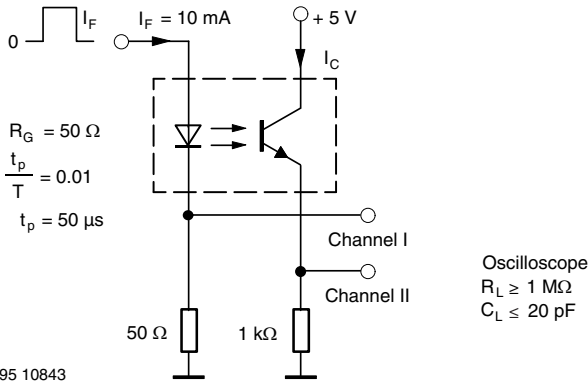

Fig. 3 - Switching Times



95 10843

Fig. 2 - Test Circuit, Saturated Operation

| SAFETY AND INSULATION RATINGS                        |                        |            |      |           |      |      |
|--|------------------------|------------|------|-----------|------|------|
| PARAMETER  | TEST CONDITION         | SYMBOL     | MIN. | TYP.      | MAX. | UNIT |
| Climatic classification (according to IEC 68 part 1) |                        |            |      | 55/100/21 |      |      |
| Comparative tracking index                           |                        | CTI        | 175  |           | 399  |      |
| Rated impulse voltage                                |                        | $V_{IOTM}$ |      |           | 8    | kV   |
| Maximum working voltages                             | Recurring peak voltage | $V_{IORM}$ |      |           | 890  | V    |
| Forward current                                      |                        | $I_{SI}$   |      |           | 275  | mA   |
| Power dissipation                                    |                        | $P_{SO}$   |      |           | 400  | mW   |
| Safety temperature                                   |                        | $T_{SI}$   |      |           | 175  | °C   |
| Creepage distance                                    |                        |            | 7.0  |           |      | mm   |
| Clearance distance                                   |                        |            | 7.0  |           |      | mm   |
| Isolation distance                                   | per IEC 60950 2.10.5.1 |            | 0.4  |           |      | mm   |

**Note**

- According to DIN EN 60747-5-5 (VDE 0884-5). These optocouplers are suitable for “safe electrical insulation” only within the safety ratings. Compliance with the safety ratings shall be ensured by means of protective circuits.

**TYPICAL CHARACTERISTICS** ( $T_{amb} = 25\text{ }^{\circ}\text{C}$ , unless otherwise specified)

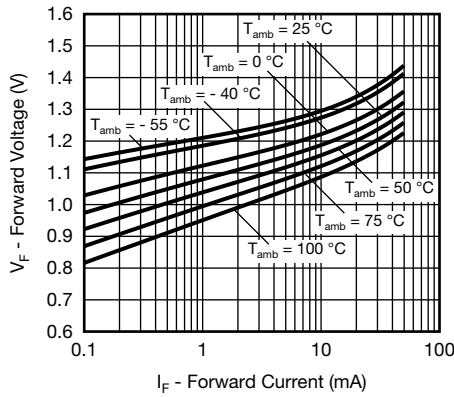

Fig. 4 - Forward Voltage vs. Forward Current



Fig. 7 - Leakage Current vs. Ambient Temperature

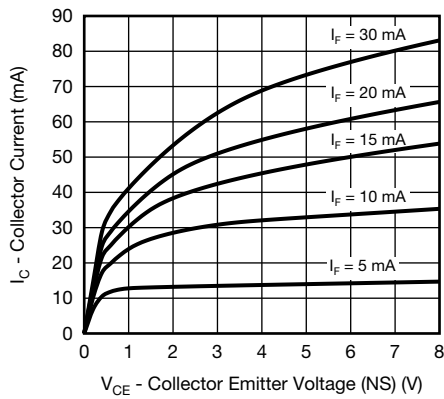

Fig. 5 - Collector Current vs. Collector Emitter Voltage (NS)



Fig. 8 - Normalized CTR (NS) vs. Ambient Temperature

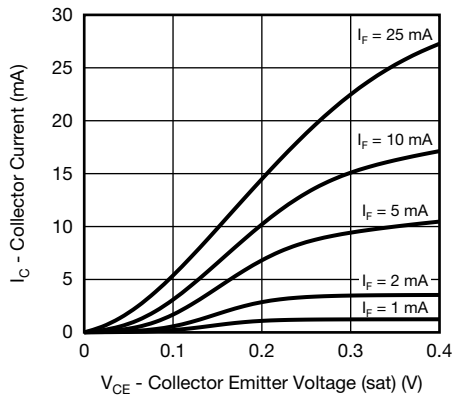

Fig. 6 - Collector Current vs. Collector Emitter Voltage (sat)

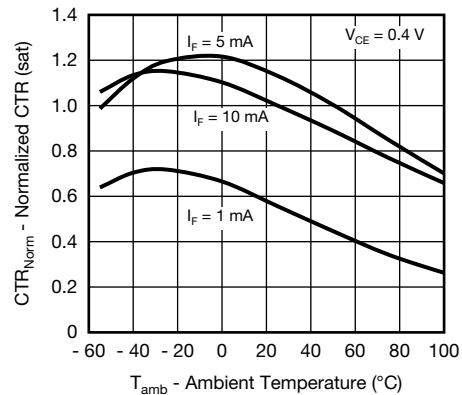

Fig. 9 - Normalized CTR (sat) vs. Ambient Temperature

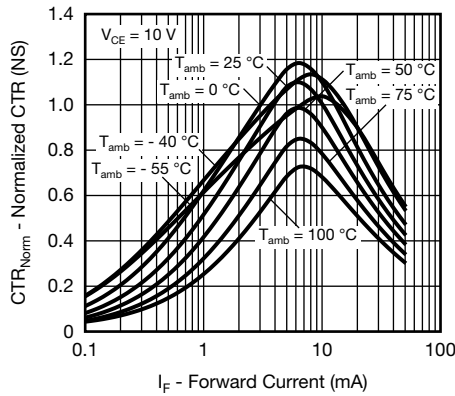

Fig. 10 - Normalized CTR (NS) vs. Forward Current



Fig. 13 - CTR Frequency vs. Collector Current

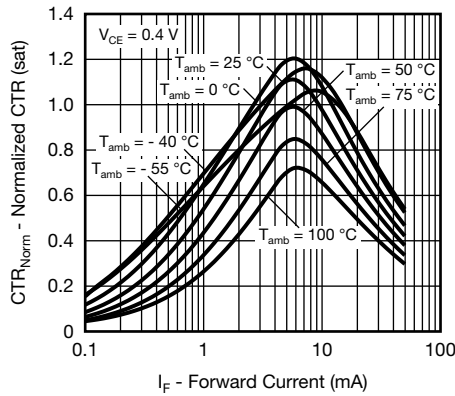

Fig. 11 - Normalized CTR (sat) vs. Forward Current



Fig. 14 - Switching Time vs. Load Resistance



Fig. 12 - CTR Frequency vs. Phase Angle



PACKAGE DIMENSIONS in millimeters



Option 6

Option 7

Option 9

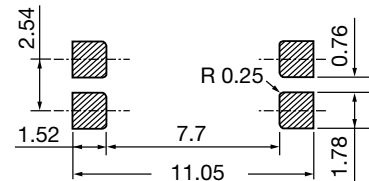
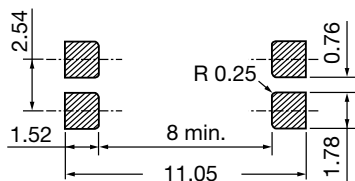
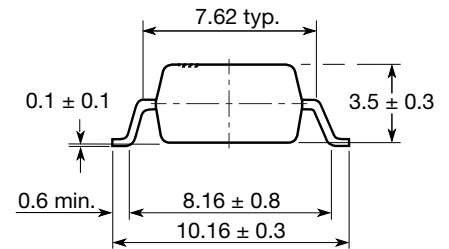
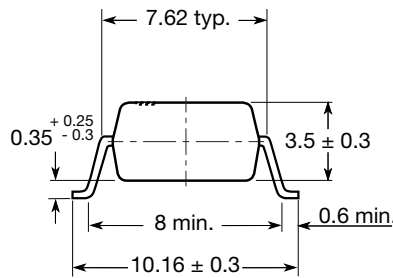
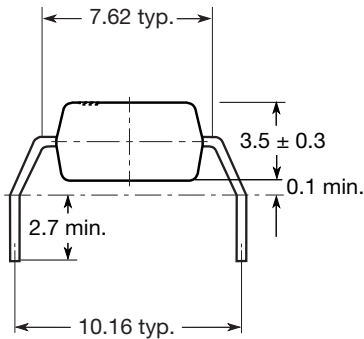

20802-28

PACKAGE MARKING (Example)



Notes

- VDE logo is only marked on option 1 parts. Option information is not marked on the part.
- Tape and reel suffix (T) is not part of the package marking.

**PACKING INFORMATION**

| DEVICE PER TUBE |            |           |           |
|-----------------|------------|-----------|-----------|
| TYPE            | UNITS/TUBE | TUBES/BOX | UNITS/BOX |
| DIP-4           | 100        | 40        | 4000      |



Fig. 15 - Tape and Reel Shipping Medium

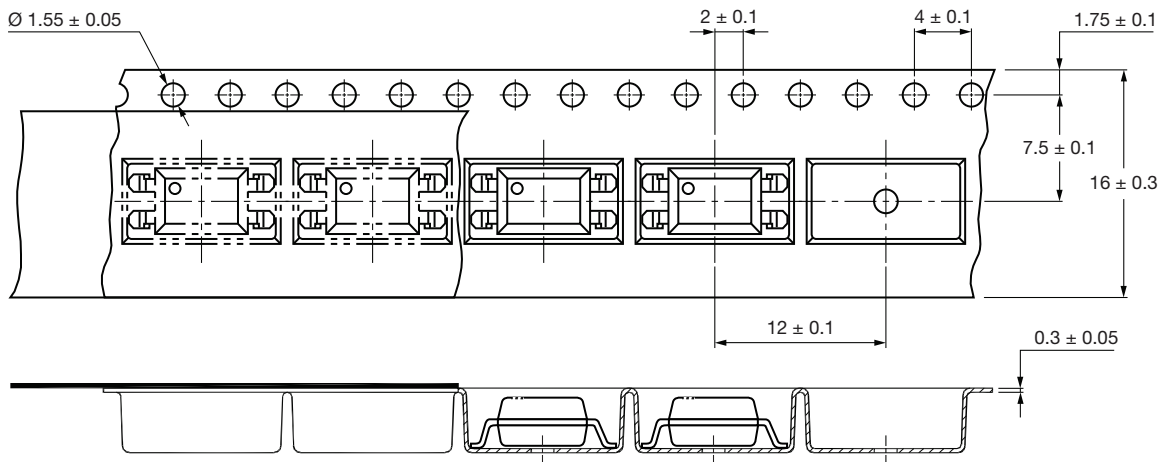

Fig. 16 - Tape and Packing for Option 7 and Option 9



Fig. 17 - Tape Packing for Option 7 and Option 9, T3 Rotation (2000 units per reel)





## Disclaimer

ALL PRODUCT, PRODUCT SPECIFICATIONS AND DATA ARE SUBJECT TO CHANGE WITHOUT NOTICE TO IMPROVE RELIABILITY, FUNCTION OR DESIGN OR OTHERWISE.

Vishay Intertechnology, Inc., its affiliates, agents, and employees, and all persons acting on its or their behalf (collectively, "Vishay"), disclaim any and all liability for any errors, inaccuracies or incompleteness contained in any datasheet or in any other disclosure relating to any product.

Vishay makes no warranty, representation or guarantee regarding the suitability of the products for any particular purpose or the continuing production of any product. To the maximum extent permitted by applicable law, Vishay disclaims (i) any and all liability arising out of the application or use of any product, (ii) any and all liability, including without limitation special, consequential or incidental damages, and (iii) any and all implied warranties, including warranties of fitness for particular purpose, non-infringement and merchantability.

Statements regarding the suitability of products for certain types of applications are based on Vishay's knowledge of typical requirements that are often placed on Vishay products in generic applications. Such statements are not binding statements about the suitability of products for a particular application. It is the customer's responsibility to validate that a particular product with the properties described in the product specification is suitable for use in a particular application. Parameters provided in datasheets and/or specifications may vary in different applications and performance may vary over time. All operating parameters, including typical parameters, must be validated for each customer application by the customer's technical experts. Product specifications do not expand or otherwise modify Vishay's terms and conditions of purchase, including but not limited to the warranty expressed therein.

Except as expressly indicated in writing, Vishay products are not designed for use in medical, life-saving, or life-sustaining applications or for any other application in which the failure of the Vishay product could result in personal injury or death. Customers using or selling Vishay products not expressly indicated for use in such applications do so at their own risk. Please contact authorized Vishay personnel to obtain written terms and conditions regarding products designed for such applications.

No license, express or implied, by estoppel or otherwise, to any intellectual property rights is granted by this document or by any conduct of Vishay. Product names and markings noted herein may be trademarks of their respective owners.

## Material Category Policy

**Vishay Intertechnology, Inc. hereby certifies that all its products that are identified as RoHS-Compliant fulfill the definitions and restrictions defined under Directive 2011/65/EU of The European Parliament and of the Council of June 8, 2011 on the restriction of the use of certain hazardous substances in electrical and electronic equipment (EEE) - recast, unless otherwise specified as non-compliant.**

**Please note that some Vishay documentation may still make reference to RoHS Directive 2002/95/EC. We confirm that all the products identified as being compliant to Directive 2002/95/EC conform to Directive 2011/65/EU.**

**Vishay Intertechnology, Inc. hereby certifies that all its products that are identified as Halogen-Free follow Halogen-Free requirements as per JEDEC JS709A standards. Please note that some Vishay documentation may still make reference to the IEC 61249-2-21 definition. We confirm that all the products identified as being compliant to IEC 61249-2-21 conform to JEDEC JS709A standards.**

Компания «Life Electronics» занимается поставками электронных компонентов импортного и отечественного производства от производителей и со складов крупных дистрибьюторов Европы, Америки и Азии.

С конца 2013 года компания активно расширяет линейку поставок компонентов по направлению коаксиальный кабель, кварцевые генераторы и конденсаторы (керамические, пленочные, электролитические), за счёт заключения дистрибьюторских договоров

Мы предлагаем:

- Конкурентоспособные цены и скидки постоянным клиентам.
- Специальные условия для постоянных клиентов.
- Подбор аналогов.
- Поставку компонентов в любых объемах, удовлетворяющих вашим потребностям.
- Приемлемые сроки поставки, возможна ускоренная поставка.
- Доставку товара в любую точку России и стран СНГ.
- Комплексную поставку.
- Работу по проектам и поставку образцов.
- Формирование склада под заказчика.
- Сертификаты соответствия на поставляемую продукцию (по желанию клиента).
- Тестирование поставляемой продукции.
- Поставку компонентов, требующих военную и космическую приемку.
- Входной контроль качества.
- Наличие сертификата ISO.

В составе нашей компании организован Конструкторский отдел, призванный помогать разработчикам, и инженерам.

Конструкторский отдел помогает осуществить:

- Регистрацию проекта у производителя компонентов.
- Техническую поддержку проекта.
- Защиту от снятия компонента с производства.
- Оценку стоимости проекта по компонентам.
- Изготовление тестовой платы монтаж и пусконаладочные работы.



Тел: +7 (812) 336 43 04 (многоканальный)

Email: [org@lifeelectronics.ru](mailto:org@lifeelectronics.ru)