

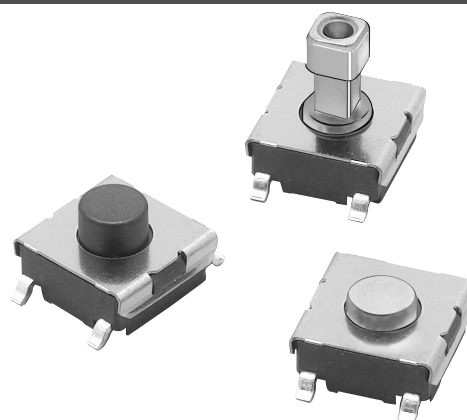



Tactile Switch (SMD) B3FS

Surface-mounting Switches Ideal for High-density Mounting

- Tape packing style also available
- Allows reflow soldering
- 3 actuator heights for design flexibility; Projected plunger versions allow installation of B32-series keytops
- RoHS Compliant



Ordering Information

Item				Model			
Type	Plunger	Height	Operating force (OF)	Bag packaging	Embossed tape packaging		
				(qty/bag)	(qty/reel)	(qty/reel)	
Standard 6 x 6 mm	Flat 	3.1 mm	General-purpose: 100 gf	B3FS-1000	100	B3FS-1000P	3,000
			High-force: 150 gf	B3FS-1002		B3FS-1002P	
	Flat 	4.3 mm	General-purpose: 100 gf	B3FS-1010		B3FS-1010P	1,000
			High-force: 150 gf	B3FS-1012		B3FS-1012P	
	Projected 	7.3 mm	General-purpose: 100 gf	B3FS-1050		B3FS-1050P	
			High-force: 150 gf	B3FS-1052		B3FS-1052P	

Note: Order in multiples of the quantities given for each package

Important Note: Switches cannot be water-washed.

Specifications

■ Characteristics

Contact form	SPST-NO	
Switching capacity	50 mA, 24 VDC (resistive load)	
Contact resistance	100 mΩ max. (rated: 1 mA, 5 VDC)	
Insulation resistance	100 MΩ min. (at 100 VDC)	
Dielectric strength	250 VAC, 50/60 Hz for 1 min.	
Bounce time	5 ms max.	
Vibration resistance	Malfunction: 10 to 55 Hz, 1.5-mm double amplitude	
Shock resistance	Destruction: 1,000 m/s ² max. (approx. 100G max.) Malfunction: 100 m/s ² max. (approx. 10G max.)	
Life expectancy	General-purpose	1,000,000 operations min.
	High-force type	300,000 operations min.
Ambient operating temperature	-25°C to +70°C (at 60% RH max.) with no icing or condensation	
Ambient operating humidity	35% to 85% (at 5 to 35°C)	
Weight	Approx. 0.2 g	

Note: Data shown are of initial value

Engineering Data

■ Operating Characteristics

Characteristics	B3FS-1000 series	
	General-purpose	High-force
Operating force (OF)	100 ± 30 gf	150 ± 50 gf
Releasing force (RF)	20 gf	50 gf
Pretravel (PT)	0.25 ^{+0.2} / _{-0.1} mm	

■ Operating Force vs Stroke (Typical Example)

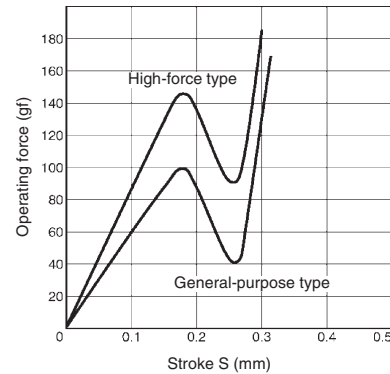

■ Accessories

See "B32" Tactile Switch Key Top data sheet for keycaps that fit projected plunger B3FS models.

Dimensions

- Note:** 1. Unless otherwise specified, all units are in millimeters and a tolerance of ± 0.4 mm applies to all dimensions.
 2. Terminal numbers are not indicated on this switch. With the switch turned over so that the logo mark "OMRON" is visible on the upper part of the rear side of the switch base, the terminal on the right of the logo mark is numbered "1" and that on the bottom right is "3." Accordingly, two terminals on the left side are numbered "2" and "4" respectively.

Flat Type

B3FS-1000
B3FS-1002
B3FS-1000P
B3FS-1002P

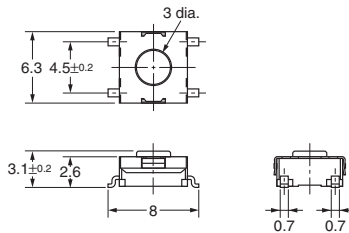

PCB Pad (Top View) (One-side PCB t= 1.6)

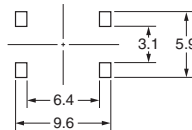

Terminal Arrangement/ Internal Connection (Top View)

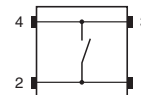

Flat Type

B3FS-1010
B3FS-1012
B3FS-1010P
B3FS-1012P

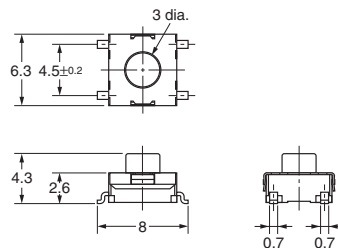

PCB Pad (Top View) (One-side PCB t= 1.6)

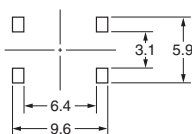

Terminal Arrangement/ Internal Connection (Top View)

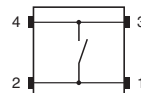

Projected Type

B3FS-1050
B3FS-1052
B3FS-1050P
B3FS-1052P

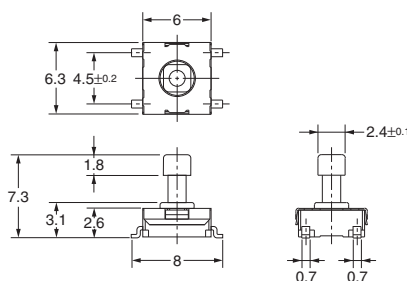
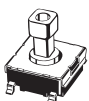

PCB Pad (Top View) (One-side PCB t= 1.6)

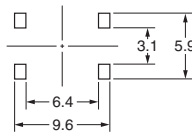

Terminal Arrangement/ Internal Connection (Top View)

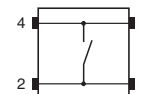

Precautions

Be sure to read the precautions common to all Tactile Switches, contained in the Technical User's Guide, "Tactile Switches, Technical Information" for correct use.



All sales are subject to Omron Electronic Components LLC standard terms and conditions of sale, which can be found at http://www.components.omron.com/components/web/webfiles.nsf/sales_terms.html

ALL DIMENSIONS SHOWN ARE IN MILLIMETERS.
To convert millimeters into inches, multiply by 0.03937. To convert grams into ounces, multiply by 0.03527.

OMRON[®]

**OMRON ELECTRONIC
COMPONENTS LLC**

55 E. Commerce Drive, Suite B
Schaumburg, IL 60173

847-882-2288

OMRON ON-LINE

Global - <http://www.omron.com>
USA - <http://www.components.omron.com>

Компания «Life Electronics» занимается поставками электронных компонентов импортного и отечественного производства от производителей и со складов крупных дистрибьюторов Европы, Америки и Азии.

С конца 2013 года компания активно расширяет линейку поставок компонентов по направлению коаксиальный кабель, кварцевые генераторы и конденсаторы (керамические, пленочные, электролитические), за счёт заключения дистрибьюторских договоров

Мы предлагаем:

- Конкурентоспособные цены и скидки постоянным клиентам.
- Специальные условия для постоянных клиентов.
- Подбор аналогов.
- Поставку компонентов в любых объемах, удовлетворяющих вашим потребностям.
- Приемлемые сроки поставки, возможна ускоренная поставка.
- Доставку товара в любую точку России и стран СНГ.
- Комплексную поставку.
- Работу по проектам и поставку образцов.
- Формирование склада под заказчика.
- Сертификаты соответствия на поставляемую продукцию (по желанию клиента).
- Тестирование поставляемой продукции.
- Поставку компонентов, требующих военную и космическую приемку.
- Входной контроль качества.
- Наличие сертификата ISO.

В составе нашей компании организован Конструкторский отдел, призванный помогать разработчикам, и инженерам.

Конструкторский отдел помогает осуществить:

- Регистрацию проекта у производителя компонентов.
- Техническую поддержку проекта.
- Защиту от снятия компонента с производства.
- Оценку стоимости проекта по компонентам.
- Изготовление тестовой платы монтаж и пусконаладочные работы.



Тел: +7 (812) 336 43 04 (многоканальный)

Email: org@lifeelectronics.ru