



HumPRO™ Series
RF Transceiver Module
Data Guide

Wireless made simple®

Warning: Some customers may want Linx radio frequency (“RF”) products to control machinery or devices remotely, including machinery or devices that can cause death, bodily injuries, and/or property damage if improperly or inadvertently triggered, particularly in industrial settings or other applications implicating life-safety concerns (“Life and Property Safety Situations”).

NO OEM LINX REMOTE CONTROL OR FUNCTION MODULE SHOULD EVER BE USED IN LIFE AND PROPERTY SAFETY SITUATIONS. No OEM Linx Remote Control or Function Module should be modified for Life and Property Safety Situations. Such modification cannot provide sufficient safety and will void the product’s regulatory certification and warranty.

Customers may use our (non-Function) Modules, Antenna and Connectors as part of other systems in Life Safety Situations, but only with necessary and industry appropriate redundancies and in compliance with applicable safety standards, including without limitation, ANSI and NFPA standards. It is solely the responsibility of any Linx customer who uses one or more of these products to incorporate appropriate redundancies and safety standards for the Life and Property Safety Situation application.

Do not use this or any Linx product to trigger an action directly from the data line or RSSI lines without a protocol or encoder/decoder to validate the data. Without validation, any signal from another unrelated transmitter in the environment received by the module could inadvertently trigger the action.

All RF products are susceptible to RF interference that can prevent communication. RF products without frequency agility or hopping implemented are more subject to interference. This module does have a frequency hopping protocol built in, but the developer should still be aware of the risk of interference.

Do not use any Linx product over the limits in this data guide. Excessive voltage or extended operation at the maximum voltage could cause product failure. Exceeding the reflow temperature profile could cause product failure which is not immediately evident.

Do not make any physical or electrical modifications to any Linx product. This will void the warranty and regulatory and UL certifications and may cause product failure which is not immediately evident.

Table of Contents

1	Description
1	Features
2	Ordering Information
2	Absolute Maximum Ratings
3	Electrical Specifications
5	Typical Performance Graphs
10	Pin Assignments
10	Pin Descriptions
12	Pre-Certified Module Pin Assignments
13	Module Dimensions
14	Theory of Operation
15	Module Description
16	Overview
18	Addressing Modes
19	Automatic Addressing
20	Acknowledgements and Assured Delivery
20	Compatibility with the 250 Series
21	Address Register Use
21	Networking
22	Transmitting Packets
23	Receiving Packets
26	Exception Engine
28	Carrier Sense Multiple Access (CSMA)
28	Using the Buffer Empty (BE) Line
29	Using the Command Response ($\overline{\text{CRESP}}$) Line
30	Using the $\overline{\text{CMD}}$ Line
30	External Amplifier Control
31	AES Encryption
32	Restore Factory Defaults

32	Using the Low Power Features
34	The Command Data Interface
36	Writing to Registers
37	Reading from Registers
38	The Command Data Interface Command Set
75	Typical Applications
76	Usage Guidelines for FCC Compliance
76	Additional Testing Requirements
77	Information to the user
78	Product Labeling
78	FCC RF Exposure Statement
78	Antenna Selection
80	Power Supply Requirements
80	Antenna Considerations
81	Interference Considerations
82	Pad Layout
83	Microstrip Details
84	Board Layout Guidelines
85	Helpful Application Notes from Linx
86	Production Guidelines
86	Hand Assembly
86	Automated Assembly
88	General Antenna Rules
90	Common Antenna Styles
92	Regulatory Considerations
94	Notes

HumPRO™ Series RF Transceiver Module

Data Guide



Description

The HumPRO™ Series is a frequency hopping spread spectrum (FHSS) transceiver designed for the reliable transfer of digital data. It has a very fast lock time so that it can quickly wake up, send data and go back to sleep, saving power in battery-powered applications. The module is available in the 915MHz frequency band.

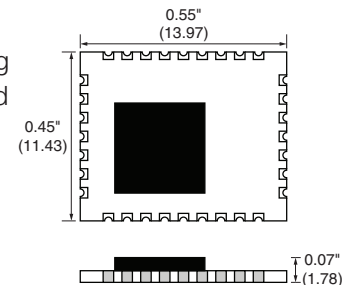

Figure 1: Package Dimensions

The module has several features that increase the data transfer reliability. It ensures that no other modules are transmitting before it begins transmitting data. Automatic acknowledgements ensure that the remote side received valid data. Multiple hopping patterns enable several systems to operate in proximity without interference. A standard UART interface is used for module configuration and data transfer. A few simple serial commands are all that are needed for configuration.

All modules have a unique 32-bit serial number that can be used as an address. Source and destination addressing support point-to-point and broadcast links. Address masking by the receiving module allows for creating subnets. Other network topologies can also be implemented.

Housed in a tiny compact reflow-compatible SMD package, the transceiver requires no external RF components except an antenna, which greatly simplifies integration and lowers assembly costs. Versions are available that have obtained FCC and Industry Canada modular certification.

Features

- FHSS Algorithm
- Fast Lock (<30ms at 115kbps)
- Low power modes
- FCC and IC Pre-certified version
- Simple UART interface
- No external RF components required
- No production tuning required
- Tiny PLCC-32 footprint

Ordering Information

Ordering Information	
Part Number	Description
HUM-***-PRO	HumPRO™ Series Data Transceiver
HUM-***-PRO-CAS	HumPRO™ Series Data Transceiver with Castellation Connection
HUM-***-PRO-UFL	HumPRO™ Series Data Transceiver with u.FL Connector
EVM-***-PRO	HumPRO™ Series Carrier Board
MDEV-***-PRO	HumPRO™ Series Master Development System
EVAL-***-PRO	HumPRO™ Series Basic Evaluation Kit

*** = Frequency; 900MHz

Figure 2: Ordering Information

Absolute Maximum Ratings

Absolute Maximum Ratings				
Supply Voltage V_{CC}	-0.3	to	+3.9	VDC
Any Input or Output Pin	-0.3	to	$V_{CC} + 0.3$	VDC
RF Input			0	dBm
Operating Temperature	-40	to	+85	°C
Storage Temperature	-40	to	+85	°C

Exceeding any of the limits of this section may lead to permanent damage to the device. Furthermore, extended operation at these maximum ratings may reduce the life of this device.

Figure 3: Absolute Maximum Ratings



Warning: This product incorporates numerous static-sensitive components. Always wear an ESD wrist strap and observe proper ESD handling procedures when working with this device. Failure to observe this precaution may result in module damage or failure.

Electrical Specifications

HumPRO™ Series Transceiver Specifications						
Parameter	Symbol	Min.	Typ.	Max.	Units	Notes
Power Supply						
Operating Voltage	V_{CC}	2.0		3.6	VDC	
TX Supply Current	I_{CCTX}					
900MHz at +10dBm			40.5	41.5	mA	1,2
900MHz at 0dBm			22	24	mA	1,2
RX Supply Current	I_{CCRX}		23.5	24.5	mA	1,2,3
Power-Down Current	I_{PDN}		0.7	6	μA	1,2
RF Section						
Operating Frequency Band	F_C				MHz	
HUM-900-PRO		902		928	MHz	
Number of hop channels						
@ 19.2kbps RF Rate			50/64			
@ 152.34kbps RF Rate			26/32			
Channel spacing						
@ 19.2kbps RF Rate			375.9		kHz	
@ 152.34kbps RF Rate			751.81		kHz	
20 dB OBW						
@ 19.2kbps RF Rate			64		kHz	
@ 152.34kbps RF Rate			315		kHz	
Receiver BW						
@ 19.2kbps RF Rate			102		kHz	
@ 152.34kbps RF Rate			232		kHz	
FSK deviation						
@ 19.2kbps RF Rate			± 19.2		kHz	
@ 152.34kbps RF Rate			± 51		kHz	
Scan time / channel (avg)						
@ 19.2kbps RF Rate			1.2		ms	
@ 152.34kbps RF Rate			0.335		ms	
FHSS Lock time						
@ 19.2kbps RF Rate			63		ms	
@ 152.34kbps RF Rate			26		ms	
Modulation			2FSK			
Data Encoding			6/7 RLL			
Number of Hop Sequences			6			

HumPRO™ Series Transceiver Specifications						
Parameter	Symbol	Min.	Typ.	Max.	Units	Notes
Receiver Section						
Spurious Emissions				-47	dBm	
IF Frequency			304.7		kHz	
Receiver Sensitivity						5
HUM-900-PRO @min rate		-98	-101		dBm	5
HUM-900-PRO @max rate		-91	-94		dBm	5
RSSI Dynamic Range			85		dB	
CSMA RSSI Threshold			-70		dBm	
Transmitter Section						
Output Power	P_O					
HUM-900-PRO		+8.5	+9.5		dBm	6
Harmonic Emissions	P_H		-41		dBc	6
Output Power Range						
HUM-900-PRO	P_H	-5		9	dB	6
Antenna Port						
RF Impedance	R_{IN}		50		Ω	4
Environmental						
Operating Temp. Range		-40		+85	$^{\circ}C$	4
Timing						
Module Turn-On Time						
Via V_{CC}		51.7		129.5	ms	4
Via POWER_DOWN			4		ms	4
Via Standby			4		ms	4
Serial Command Response						
Volatile R/W			0.4	5	ms	8
NV Update			2.2	31.5	ms	8
Factory Reset			107		ms	8
Channel Dwell Time				400	ms	
CMD low to trigger TX with option TXnCMD	t_{TXnCMD}	2			ms	
Interface Section						
UART Data rate		9,600		115,200	bps	
Input						
Logic Low	V_{IL}			$0.3 \cdot V_{CC}$	VDC	
Logic High	V_{IH}	$0.7 \cdot V_{CC}$			VDC	

HumPRO™ Series Transceiver Specifications						
Parameter	Symbol	Min.	Typ.	Max.	Units	Notes
Output						
Logic Low, RFACTV, BE	V_{OLM}			$0.3 \cdot V_{CC}$	VDC	1,9
Logic High, RFACTV, BE	V_{OHM}	$0.7 \cdot V_{CC}$			VDC	1,9
Logic Low	V_{OL}			$0.3 \cdot V_{CC}$		1,10
Logic High	V_{OH}	$0.7 \cdot V_{CC}$				1,10
CRESP Hold Time			10		Bits	11
Flash (Non-Volatile) Memory Specifications						
Flash Write Cycles		22,000			cycles	12
<ol style="list-style-type: none"> Measured at 3.3V V_{CC} Measured at 25$^{\circ}C$ Input power < -60dBm Characterized but not tested PER = 5% Into a 50-ohm load No RF interference From end of command to start of response 60mA source/sink 6mA source/sink End of CMD_DATA_OUT stop bit to change in CRESP Number of register write operations 						

Figure 4: Electrical Specifications

Typical Performance Graphs

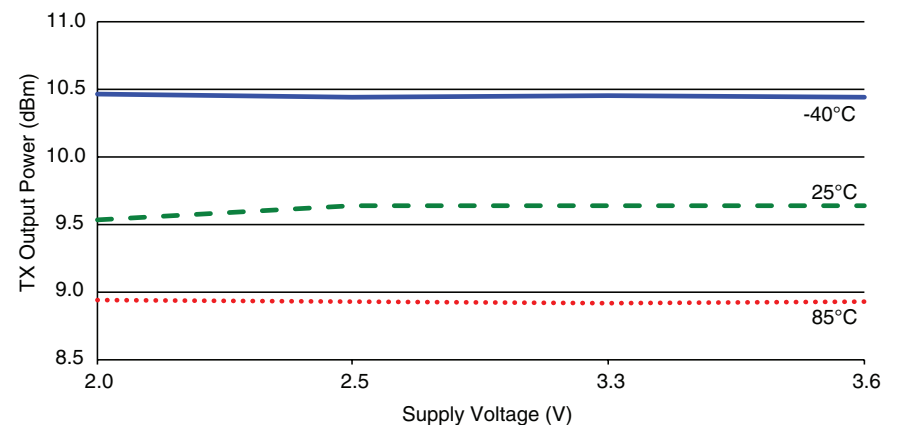

Figure 5: HumPRO™ Series Transceiver Max Output Power vs. Supply Voltage - HUM-900-PRO

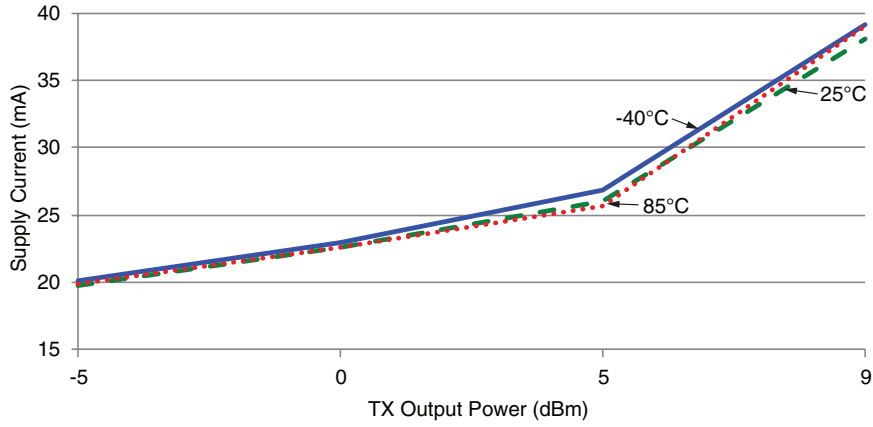

Figure 6: HumPRO™ Series Transceiver Average Current vs. Transmitter Output Power at 2.5V - HUM-900-PRO

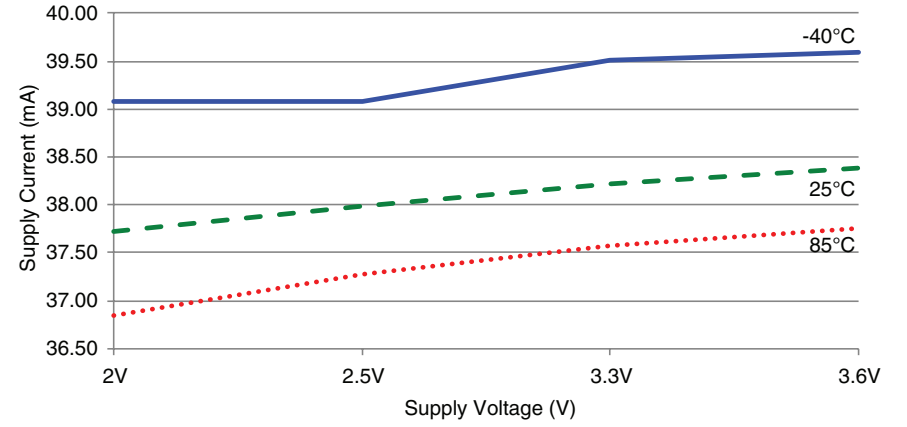

Figure 9: HumPRO™ Series Transceiver TX Current vs. Supply Voltage at Max Power - HUM-900-PRO

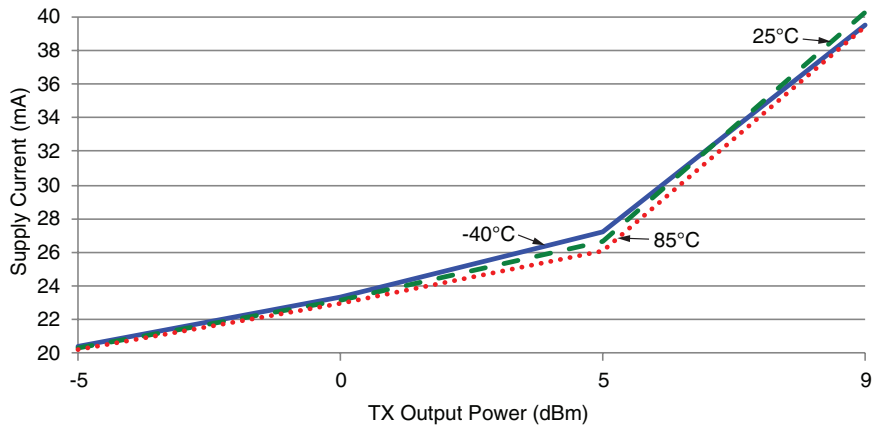

Figure 7: HumPRO™ Series Transceiver Average TX Current vs. Transmitter Output Power at 3.3V - HUM-900-PRO

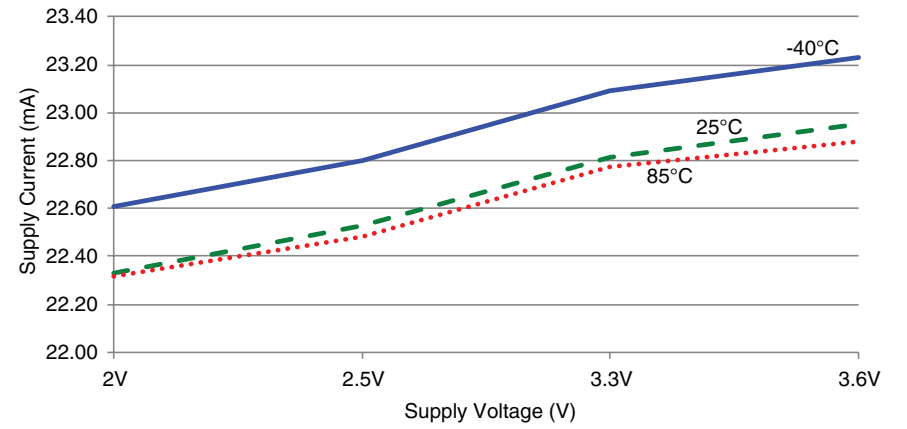

Figure 8: HumPRO™ Series Transceiver TX Current vs. Supply Voltage at 0dBm - HUM-900-PRO



Figure 10: HumPRO™ Series Transceiver RX Scan Current vs. Supply Voltage, 9.6kbps - HUM-900-PRO

Current consumption while the module is scanning for a transmission. The current is approximately 0.5mA higher when receiving data at 9.6kbps.

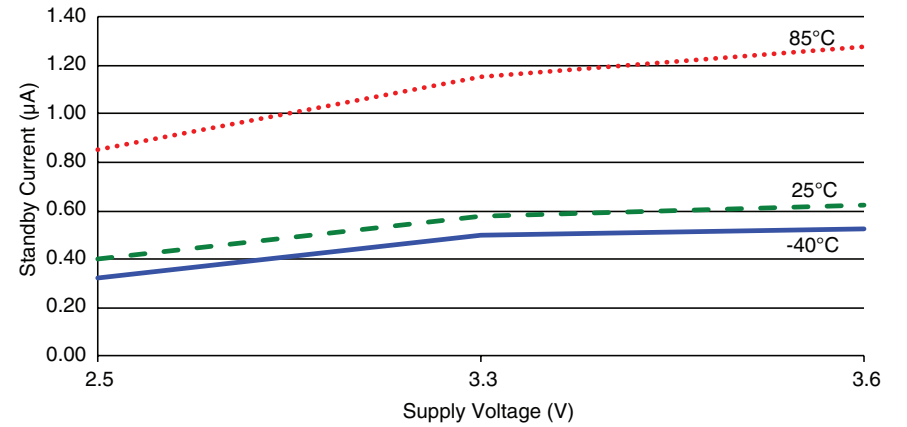

Figure 12: HumPRO™ Series Transceiver Standby Current Consumption vs. Supply Voltage - HUM-900-PRO

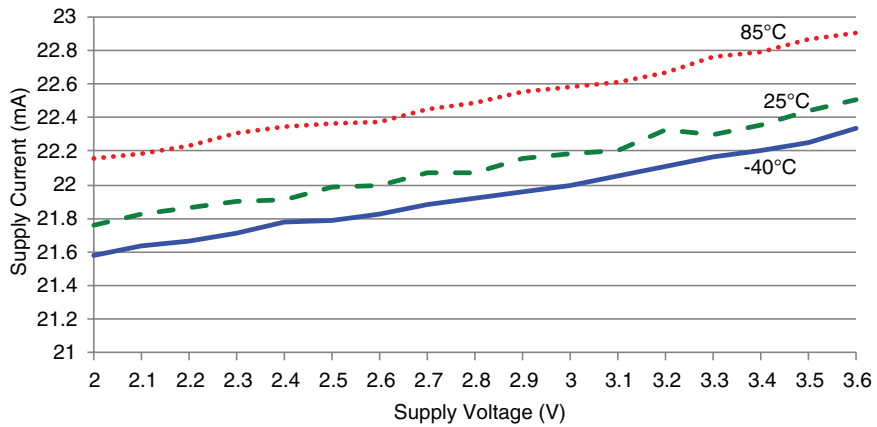

Figure 11: HumPRO™ Series Transceiver RX Scan Current vs. Supply Voltage, 115.2kbps - HUM-900-PRO

Current consumption while the module is scanning for a transmission. The current is approximately 2mA higher when receiving data at 115.2kbps.

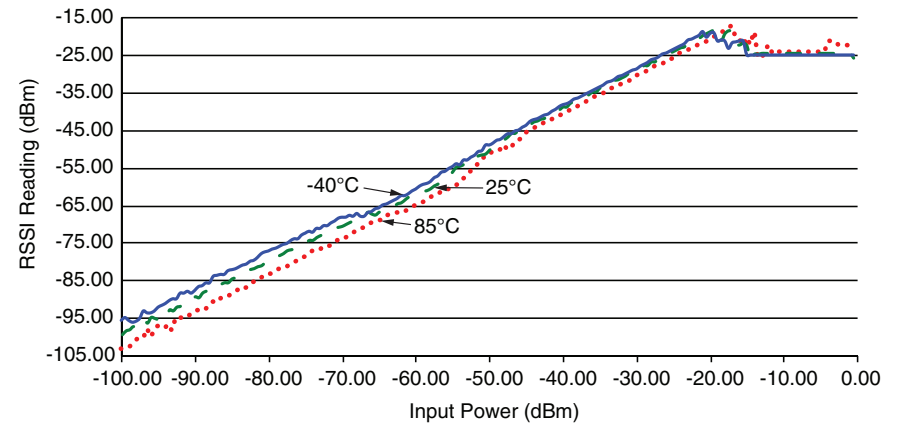

Figure 13: HumPRO™ Series Transceiver RSSI Voltage vs. Input Power - HUM-900-PRO

Pin Assignments

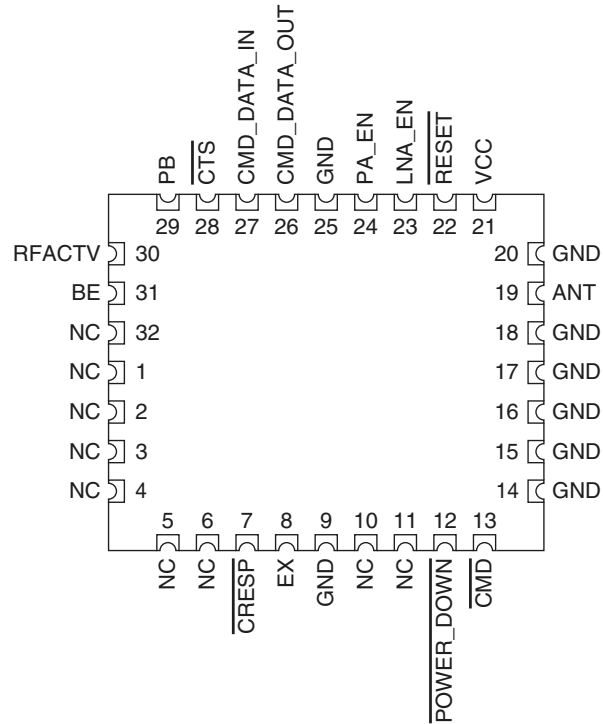

Figure 14: HumPRO™ Series Transceiver Pin Assignments (Top View)

Pin Descriptions

Pin Descriptions			
Pin Number	Name	I/O	Description
1, 2, 3, 4, 5, 6, 10, 11, 32	NC	—	No Electrical Connection. Do not connect any traces to these lines.
7	$\overline{\text{CRESP}}$	O	Command Response. This line is low when the data on the CMD_DATA_OUT line is a response to a command and not data received over the air.
8	EX	O	Exception Output. A mask can be set to take this line high when an exception occurs. The line is lowered when the exception register is read (EXCEPT).
9, 14, 15, 16, 17, 18, 20, 25	GND	—	Ground
12	$\overline{\text{POWER_DOWN}}$	I	Power Down. Pulling this line low places the module into a low-power state. The module is not functional in this state. Pull high for normal operation. Do not leave floating.

Pin Descriptions			
Pin Number	Name	I/O	Description
13	$\overline{\text{CMD}}$	I	Command Input. When this line is low, incoming bytes are command data. When high, incoming bytes are data to be transmitted.
19	ANTENNA	—	50-ohm RF Antenna Port
21	VCC	—	Supply Voltage
22	$\overline{\text{RESET}}$	I	This line resets the module when pulled low. It should be high for normal operation. This line has an internal 10k resistor to supply, so leave it unconnected if not used.
23	LNA_EN	O	Low Noise Amplifier Enable. This line is driven high when receiving. It is intended to activate an optional external LNA.
24	PA_EN	O	Power Amplifier Enable. This line is driven high when transmitting. It is intended to activate an optional external power amplifier.
26	CMD_DATA_OUT	O	Command Data Out. Output line for data and serial commands
27	CMD_DATA_IN	I	Command Data In. Input line for data ($\overline{\text{CMD}}$ is high) and serial commands ($\overline{\text{CMD}}$ is low).
28	$\overline{\text{CTS}}$	O	UART Clear To Send, active low. This line indicates to the host microcontroller when the module is ready to accept data. When $\overline{\text{CTS}}$ is high, the module is busy. When $\overline{\text{CTS}}$ is low, the module is ready for data.
29	PB	I	Reset non-volatile memory. A sequence of 4 high pulses on this line, followed by a prolonged high state causes the module to reset the non-volatile configuration parameters to factory default values.
30	RFACTV	O	RF Packet Transfer. This line goes high when the module is transmitting a packet, receiving a potentially valid packet or when the PB line is high
31	BE	O	Buffer Empty. This line is high when the UART input buffer is empty, indicating that all data has been transmitted. If acknowledgment is active, it also indicates that the receiving module has acknowledged the data or a retry exception has occurred.

Figure 15: HumPRO™ Series Transceiver Pin Descriptions

Pre-Certified Module Pin Assignments

The pre-certified version of the module has mostly the same pin assignments as the standard version. The antenna connection is routed to either a castellation (-CAS) or a u.FL connector (-UFL), depending on the part number ordered.

The antenna =pad is disconnected on the version with the connector. The RF is routed as shown in Figure 16 for the version without the connector.

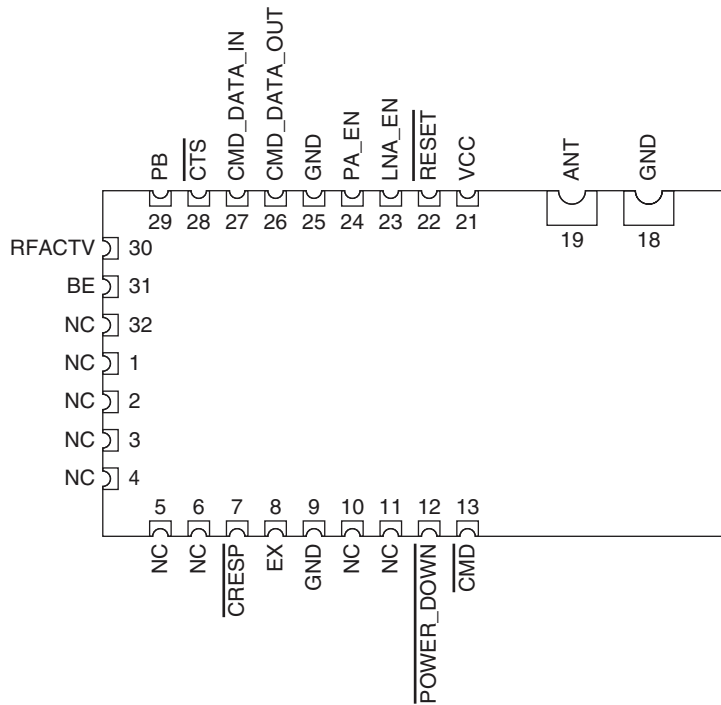

Figure 16: HumPRO™ Series Transceiver Pre-certified Version Pin Assignments (Top View)

Module Dimensions

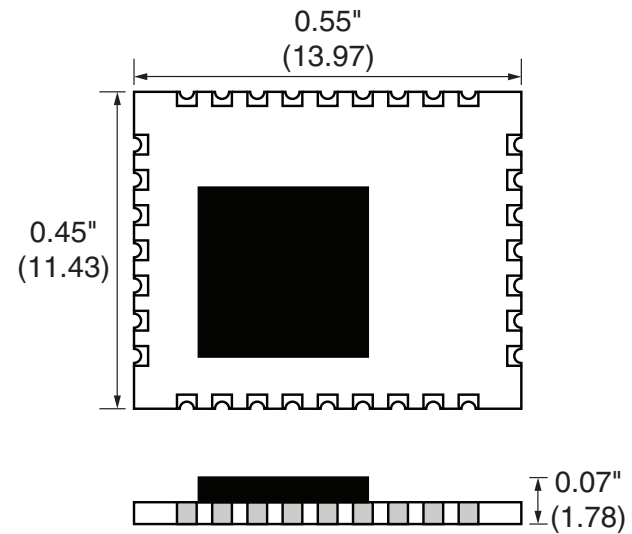

Figure 17: HumPRO™ Series Transceiver Dimensions

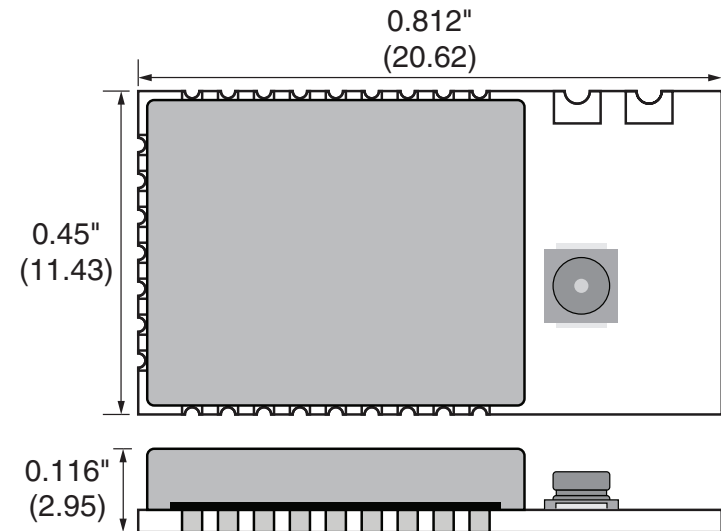

Figure 18: HumPRO™ Series Transceiver Pre-certified Version Dimensions

Theory of Operation

The HumPRO™ Series transceiver is a low-cost, high-performance synthesized FSK / MSK transceiver. Figure 19 shows the module's block diagram.

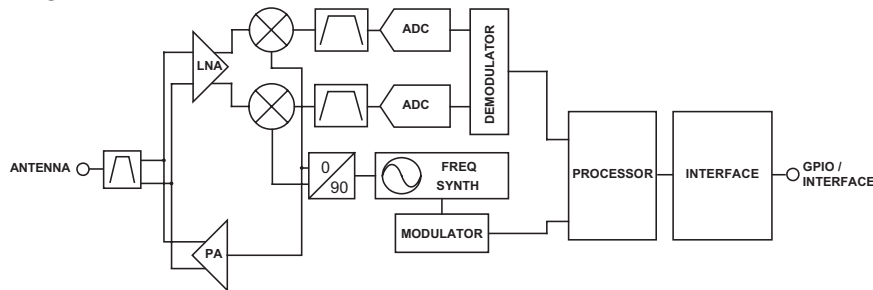

Figure 19: HumPRO™ Series Transceiver RF Section Block Diagram

The HumPRO™ Series transceiver operates in the 902 to 928MHz frequency band. The transmitter output power is programmable. The range varies depending on the antenna implementation and the local RF environment.

The RF carrier is generated directly by a frequency synthesizer that includes an on-chip VCO. The received RF signal is amplified by a low noise amplifier (LNA) and down-converted to I/Q quadrature signals. The I/Q signals are digitized by ADCs.

A low-power onboard communications processor performs the radio control and management functions including Automatic Gain Control (AGC), filtering, demodulation and packet synchronization. A control processor performs the higher level functions and controls the serial and hardware interfaces.

A crystal oscillator generates the reference frequency for the synthesizer and clocks for the ADCs and the processor.

Module Description

The HumPRO™ Series module is a completely integrated RF transceiver and processor designed to transmit digital data across a wireless link. It employs a fast-locking FHSS system for noise immunity and higher transmitter output power as allowed by government regulations.

When the module does not have data to send it scans all of the channels for incoming data. If it finds a valid preamble, it pauses and looks for the start of a packet. When it receives a valid packet with a matching destination address the module outputs the data through the UART.

The transmitting module accepts packets through its UART until a configurable number of bytes is reached or a configurable timeout expires between bytes on the UART. At this point the module transmits the packet.

When the module has data to send it goes to the next channel in its hopping pattern. It measures the RSSI on that channel to ensure that the channel is clear. If the RSSI check passes, then it transmits the packets. If the RSSI fails, then it implements a random wait time and tries again. When the channel is clear, the module transmits the data.

The module can stay on one channel for up to 400ms. If the module is ready to start transmitting near the end of the channel time, it transmits the number of bytes that it can in the remaining time. It then hops to the next channel in its hopping pattern to transmit the remaining data.

The module supports automatic acknowledgements for assured delivery. When enabled, the receiving module responds to a valid transmission with an acknowledgement to let the transmitting module know that it received the data. If an acknowledgement is not received then the transmitting module repeats the transmission for a configurable number of retries. If the retry limit is exceeded without an acknowledgement then the transmitting module issues an exception error to let the host micro know of the communication problem.

A standard UART interface is used to configure the module for operation and for the data input and output. This is suitable for direct connection to UARTs on many microcontrollers, USB converters and RS-232 converters. A simple command set is used for configuration and control.

Modules can be pre-configured for fixed point-to-point or broadcast topologies allowing streaming data (no commands) during operation.

Overview

The HumPRO Series RF transceiver module offers a number of features that make it suitable for many data transfer applications. This section provides a basic overview of the features while following sections dive into them in more detail.

Addressing

The modules have a very powerful addressing method. Each module is given a unique 16 or 32 bit address. The receiving modules use an address mask that determines how it responds to a received transmission.

The addressing and masking allow for the creation of point-to-point, many-to-one and one-to-many wireless links. This allows the creation of many network topologies, such as star, tree and mesh. The routing for the network topology is managed outside the module.

The addressing is the primary configuration when getting started with the modules. RG-00105, the HumPRO Addressing Mode Reference Guide has details about configuring the addressing.

Acknowledgements and Assured Delivery

The modules support assured delivery in the form of acknowledgements and retries. When the acknowledgements are enabled, the receiving device sends an acknowledge message to let the sender know that the transmission was received. If the sender does not get an acknowledgement it resends the message up to a configurable number of retries. If there is still no acknowledgement, the module triggers an exception to let the host processor know of the error.

Command Mode and Data Mode

The module has two main interface modes controlled by the state of the $\overline{\text{CMD}}$ line. Command mode routes the data coming in on the CMD_DATA_IN line to the processor for configuring the module. Data mode routes the data to the transmitter for transmission over-the-air. The $\overline{\text{CMD}}$ line is normally controlled by an external microcontroller.

Carrier Sense Multiple Access (CSMA)

The module implements a Carrier Sense Multiple Access method. It listens to the channel and makes sure that it is clear before it transmits. If the channel is in use, the module waits for it to clear or hops to the next channel if the channel time expires. This reduces the overall potential for interference and improves the robustness of the link.

Streaming Data and Explicit Packets

The module's default configuration is for streaming data. In this operation the module sends the data at a higher rate over-the-air than it is input on the UART. This hides the time required for the protocol transactions and the frequency hopping. The result is that the data appears to stream through the module with no breaks in the data apparent to the host processor.

Alternatively, the module can be configured for explicit packet transmission. This allows the host processor to control when packets are sent and what data is in each packet

Exceptions and Host Processor Interface

The module has several indicator lines that provide feedback to the host processor on the module's operation and current status. This includes an exception engine that informs the processor when errors occur so that it can take steps to manage the issue gracefully. The state of the status lines can also be read through the module's Command Data Interface to reduce the number of hardware connections that are required.

Encryption

The module supports AES-128 encryption to provide a secure wireless link. All of the modules must have encryption enabled and be using the same key in order for communication to be successful. There are two ways of entering an encryption key: directly by writing the key to registers through the Command Data Interface or through a pairing operation.

Encryption is not yet enabled on the initial release of HumPRO modules.

Command Data Interface

The module has a Command Data Interface that consists of a set of serial commands entered through a UART. These are shorter and simpler than AT commands that are popular with many modules. These commands control the configuration of the module as well as allow feedback on the operation and status of the module.

Addressing Modes

The module has very flexible addressing schemes selected with the ADDMODE register. It can be changed during operation. The transmitting module addresses packets according to the addressing mode configuration. The receiving module processes all addressing types regardless of the ADDMODE configuration. If the received message matches the addressing criteria, it is output on the UART. Otherwise it is discarded. The ADDMODE configuration also enables assured delivery.

There are three addressing modes: DSN, User and Extended User. Each mode offers different communications schemes, but all use source and destination addressing. The source address is for the transmitting unit, the destination address is the intended receiver. Each mode uses different registers for the source and destination addresses.

All three addressing modes can be configured to be compatible with the older 250 Series modules. The default operation has an additional level of masking on the receiving module that helps prevent interference from adjacent networks.

The following sections give brief descriptions of the three modes, but a detailed explanation and examples are given in RG-00105, the HumPRO™ Addressing Mode Reference Guide.

DSN Addressing Mode

Device Serial Number Addressing mode is the simplest mode and supports point-to-point communications. Each module is programmed at the factory with a unique 4-byte serial number that cannot be changed. These bytes are found in the non-volatile read-only MYDSN registers (MYDSN[3-0]). DSN Addressing mode uses this serial number as an address. The transmitting unit's DSN is used as the source address and the intended receiver's DSN is written into the destination address registers (DESTDSN[3-0]). All modules within range hear the transmission, but only the module with the serial number that matches the destination address outputs the data on its UART. All others ignore the transmission.

User Addressing Mode

User Addressing Mode is a more flexible method than DSN Addressing Mode. It uses the customer ID bytes (CUSTID[1-0]) and two of the user destination bytes (UDESTID[1-0]) as a destination address. The customer ID bytes are programmed at the factory and cannot be changed. These are determined by the factory for specific customers to prevent their systems from operating with any other systems. Contact Linx for more details.

The module's local address is contained in two of the user source ID registers (USRCID[1-0]). In this mode, USRCID [1-0] contain the node address and USRCID [3-2] must be 0 in the receiver.

In normal operation each module has a user ID mask (UMASK[3-0]) that splits the 32 address bits into three fields to provide a network address and address fields for sub-networks, supporting both individual addressing and broadcast addressing within the user's network. A detailed explanation and examples are given in Reference Guide RG-00105. This mode only uses the 16 bits in the USRCID[1-0] registers, but the mask includes the 16 high order 0 bits in USRCID[3-2].

If acknowledgements are enabled, only the module with a user source ID that exactly matches the transmitted user destination ID responds. The mask is not used for this determination.

Extended User Addressing Mode

Extended User Addressing mode is the same as User Addressing mode but uses 32-bit addresses. The two customer ID bytes are still used (CUSTID[1-0]) but four bytes are used for the user destination address (UDESTID[3-0]), user source ID (USRCID[3-0]) and user ID mask (UMASK[3-0]). This provides more addressing capabilities at the expense of more overhead in the packet.

Automatic Addressing

The module supports an automatic addressing mode that reads the Source Address from a valid received packet and uses it to fill the Destination Address register. This makes sure that a response is sent to the device that transmitted the original message. This also allows the host microcontroller to read out the address of the sending unit. The automatic addressing is enabled for the different addressing modes with register AUTOADDR.

Acknowledgements and Assured Delivery

When a module transmits with assured delivery enabled, the receiving module returns an acknowledgement packet. The transmitting module waits for this acknowledgement for a preset amount of time based on the data rate. If an acknowledgement is not received, it retransmits the packet. If the receiver receives more than one of the same packet, it discards the duplicate packet contents but sends an acknowledgment. This way, duplicate data is not output by the module.

If the received destination address matches the local address, the receiving module immediately sends an acknowledgement. This packet lets the sending module know that the message has been received. An acknowledgement packet is sent immediately following reception; CSMA delay is not applied to these packets since permission belongs to the interacting modules. When the sending module receives the acknowledgement packet, it marks the current block of data as completed. If this is the last message in the queue, the sending module takes the BE line high to indicate that all outgoing data has been sent.

Assured delivery should only be used when addressing a specific module in a point-to-point link. It should not be used when multiple receivers are enabled. When address masking is used, only the receiver with an exact match to the address in the transmitted packet responds. If none of the enabled receivers has an exact match, then there is no response and the transmitting module continues to re-transmit the data until the max number of retries is attempted. This causes the transmitting module to appear slow or unresponsive. It also impedes valid communications.

Compatibility with the 250 Series

When DSN mode is used with a specific address, the module can communicate with 250 Series modules at UART data rates of 38,400 to 115,200 bps. For other addressing modes, the HumPRO™ Series modules can be configured to operate with them. Setting the COMPAT register to 0x00 enables the compatible operation. This allows mixed-mode systems and upgrades of legacy products that still maintain backwards compatibility. Only the higher baud rates are compatible.

The main feature of compatibility operation is that it configures the same addressing methods used by the 250 Series. These methods are more susceptible to interference from adjacent networks of 250 Series modules which use DSN (GUI) broadcast messages. Please see Reference Guide RG-00105 for more details.

Address Register Use

Figure 20 shows the address registers that are used with each addressing mode.

HumPRO™ Series Transceiver Address Registers						
COMPAT	0x00 (Relaxed Addressing)			0x02 (Normal Addressing)		
	0x04 (DSN)	0x06 (User)	0x07 (Ex User)	0x04 (DSN)	0x06 (User)	0x07 (Ex User)
ADDMODE	0x14 (DSN +ACK)	0x16 (User +ACK)	0x17 (ExUser +ACK)	0x14 (DSN +ACK)	0x16 (User +ACK)	0x17 (ExUser +ACK)
UDESTID[3-0]			X			X
UDESTID[1-0]		X			X	
USRC[3-0]			X		X	X
USRC[1-0]		X				
UMASK[3-0]			X		X	X
UMASK[1-0]		X				
DESTDSN[3-0]	X			X		

Figure 20: HumPRO™ Series Transceiver Address Register Use

Networking

The HumPRO™ Series modules can be used to create many types of wireless networks. The modules do not provide network routing since the internal memory size of the module would limit the overall network size. The HumPRO™ can work as the MAC/PHY layers of a network stack and the memory and processing speed of the external microcontroller can be sized according to the size of the network that is needed for the application.

This requires more software development, but avoids the cost of adding extra memory on the module for applications that don't need it. Linx can assist with network frameworks and concepts and can create custom designs on a contract basis. Contact Linx for more details.

Transmitting Packets

In default operation when transmitting, the host microcontroller writes bytes to the CMD_DATA_IN line while the $\overline{\text{CMD}}$ line is held high at the baud rate selected by the UARTBAUD register. The incoming bytes are buffered until one of four conditions triggers the packet to be transmitted:

1. The number of bytes in the buffer exceeds the value in the Byte Count Trigger (BCTRIG) register.
2. The time since the last received byte exceeds the value in the Data Timeout (DATATO) register.
3. A SENDP command is written to the CMD register.
4. The number of buffered bytes exceeds what can be sent before the radio must hop channels.

The first three conditions can be controlled by the host microcontroller. In the last case, the module transmits what it can in the remaining time then sends the rest on the next channel. This can cause the data to be divided up into multiple packets and is not within the control of the host micro.

In cases where it is desired for all data to be sent in the same packet or where the microcontroller needs a greater level of control over the radio, the HumPRO™ offers explicit control of packet transmission through options in the PKTOPT register.

When the TXPKT option is enabled (PKTOPT register, bit 0 = 1), the data is held until a SENDP command is written to the CMD register. Alternatively, if option TXnCMD is enabled (PKTOPT register, bit 1 = 1), then lowering the $\overline{\text{CMD}}$ line triggers the packet transmission, reducing the number of UART transactions that are required. The BCTRIG and DATATO conditions are ignored when these options are enabled.

Once triggered, the transmitted packet contains the bytes in the buffer as of the trigger event, even if more data bytes are received before the packet can be sent. Multiple outgoing packets can be buffered in this way.

If the full packet cannot be sent in the time remaining on the current channel, then it is held until the module hops to the next channel.

This option gives the host microcontroller very fine control over when packets are transmitted and what they contain.

Receiving Packets

In default operation when receiving packets, the module outputs all received bytes as soon as the packet is validated (CRC checks pass) and if the addressing permits it at the baud rate selected by the UARTBAUD register. No command or control bytes are output and no action is required of an external microcontroller. The first byte from a packet directly follows the last byte of the previously received packet.

In cases where the host microcontroller needs more control over the data or where dynamic configuration changes could set up race conditions between incoming data and outgoing commands, the module offers explicit control over received packets.

When the RXPKT option is enabled (PKTOPT register, bit 2 = 1), received data is output on the CMD_DATA_OUT line one packet at a time when a GETPH, GETPD, or GETPHD command is written to the CMD register. Writing one of these commands begins the received packet transfer cycle.

Two lines are used as flow control and indicators during the transfer cycle. The $\overline{\text{CMD}}$ line is controlled by the host microcontroller. The module uses either the $\overline{\text{CTS}}$ line or the $\overline{\text{CRESP}}$ line as a status line, depending on the state of the RXP_CTS option in the PKOPT register.

When a valid packet is received, the EX_RXWAIT exception flag is set in the EEXFLAG1 register. If the corresponding bit in the EEXMASK1 register is set, then the EX line goes high. The host microcontroller can monitor the EX line or periodically check the EEXFLAG or LSTATUS registers to determine if data is ready to be read.

The transfer cycle is begun by writing a Get Packet Header (GETPH), Get Packet Data (GETPD), or Get Packet Header and Data GETPHD command to the CMD register. The module sends the command ACK byte and sets the selected status line high. Once the status line goes high, the host microcontroller sets the $\overline{\text{CMD}}$ line high and the module outputs the received data. The command sent determines whether the bytes sent are the header, data, or header followed by data.

When all packet bytes have been sent the control line goes low. When the host microcontroller detects that the line is low, it sets $\overline{\text{CMD}}$ low, completing the transfer cycle. The cycle is shown in Figure 21.

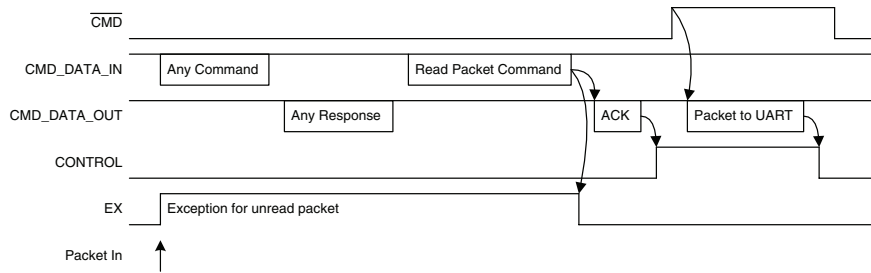

Figure 21: HumPRO™ Series Transceiver Received Packet Transfer Cycle

If a GETPH was sent and header data received, the following data can then be read by repeating the cycle with the GETPD command. If the next GETPx command is a GETPH or GETPHD, the data associated with the header read by GETPH is discarded and the header or header plus data of the following packet is returned.

If there is RF-received data waiting to be sent to the UART and the mask for EX_RXWAIT is set in the EEXMASK register, EX is raised if it is low.

If there is no packet waiting when a GETPx command is sent, the control line is still taken high and not reset until after $\overline{\text{CMD}}$ goes high, thereby performing a zero-byte transfer cycle.

Although not part of the normal packet transfer, if $\overline{\text{CMD}}$ is set low while the control line is high (received packet transfer in progress), data transmission stops, the control line goes low, and the module processes and responds to incoming commands. If $\overline{\text{CMD}}$ is again taken high, the control line is raised and the packet transfer continues where it left off. This gives the host microcontroller very fine control over when received packets are output and how much data needs to be managed.

The header and data structures for explicit packets are shown in Figure 22.

The Tag field identifies the start of the block and if it is the header information (0x01) or the packet data (0x02).

The Header Length field identifies the number of header bytes that follow.

The Frame Type field identifies what kind of packet was received. The values are shown in Figure 23.

The Hop ID field is the hop sequence number, 0 - 5.

DSN Address Packet Header

Tag	Header Length	Frame Type	Hop ID	Sequence	Dest DSN	Source DSN	Data Length
0x01	1	1	1	1	4	4	1

User Address Packet Header

Tag	Header Length	Frame Type	Hop ID	Sequence	Cust ID	Dest Addr	Source Addr	Source DSN	Data Length
0x01	1	1	1	1	2	2 or 4	2 or 4	4	1

Packet Data

Tag	Data Length	Data
0x02	1	Data Length Bytes

Figure 22: HumPRO™ Series Transceiver Packet Header and Data Structure

HumPRO™ Series Transceiver Frame Types

Exception Mask	Exception Name
0x04	DSN Addressing Mode
0x14	DSN Addressing with Acknowledgement
0x06	User Addressing Mode
0x16	User Addressing with Acknowledgement
0x07	Extended User Addressing Mode
0x17	Extended User Addressing with Acknowledgement

Figure 23: HumPRO™ Series Transceiver Frame Types

The Sequence byte is incremented for each new packet, modulo 255. A received packet is discarded if the sequence byte matches the previously received packet to prevent delivering duplicate copies of an automatically retransmitted packet.

The Cust ID field is a number that can be assigned to a specific customer. Only modules with the same customer ID respond to transmissions. By default, Cust ID is 0x7FFF for packets transmitted with $\text{COMPAT} = 2$ or 0xFFFF for packets transmitted with $\text{COMPAT} = 0$.

The Dest Addr field has the received destination address. This is 2 bytes long with User Addressing Mode and 4 bytes with DSN and Extended User Addressing Modes.

The Source Addr Field is the address of the transmitting module. This is 2 bytes long with User Addressing Mode and 4 bytes with DSN and Extended User Addressing Modes.

The Data Length byte indicates how many bytes of data are in the packet. This value is the same in the packet header and the associated data.

Exception Engine

The HumPRO™ is equipped with an internal exception engine to notify the host microcontroller of an unexpected event. If errors occur during module operation, an exception is raised. There are two methods of driving the EX pin when an exception condition exists:

1. From the EXMASK and EXCEPT registers (legacy operation)
2. From the EEXMASKx and EEXFLAGx registers (standard operation)

If EXMASK is non-zero, the first method is used, otherwise the second method is used.

For legacy operation with the 250 and 25 Series, the EX line is set and reset by the Exception (EXCEPT) register processing. It is set when an exception occurs and the exception code ANDed with the current Exception Mask (EXMASK) register is non-zero. It is reset when the EXCEPT register is read through a command. No other operations affect the state of EX. Setting EXMASK non-zero does not change the state of EX.

If an exception code is already present in the register when an error occurs, the new exception code overwrites the old value. Exception codes are organized by type for ease of masking. Figure 24 lists the exception codes and their meanings.

HumPRO™ Series Transceiver Exception Codes		
Exception Code	Exception Name	Description
0x08	EX_BUFOVFL	Incoming UART buffer overflowed.
0x09	EX_RFOVFL	Outgoing UART buffer overflowed.
0x13	EX_WRITEREGFAILED	Attempted write to register failed.
0x20	EX_NORFACK	Acknowledgement packet not received after maximum number of retries.
0x40	EX_BADCRC	Bad CRC detected on incoming packet.
0x42	EX_BADHEADER	Bad CRC detected in packet header.
0x43	EX_BADSEQID	Sequence ID was incorrect in ACK packet.
0x44	EX_BADFRAMETYPE	Attempted transmit with Invalid setting in reg:NETMODE or invalid packet type in received packet header

Figure 24: HumPRO™ Series Transceiver Exception Codes

The EX line can be asserted to indicate to the host that an error has occurred. The EXCEPT register must be read to reset the line. Figure 25 lists some example exception masks.

HumPRO™ Series Transceiver Example Exception Masks	
Exception Mask	Exception Name
0x08	Allows only EX_BUFOVFL and EX_RFOVFL to trigger the EX line
0x10	Allows only EX_WRITEREGFAILED to trigger the EX line
0x20	Allows only EX_NORFACK to trigger the EX line
0x40	Allows only EX_BADCRC, EX_BADHEADER, EX_BADSEQID and EX_BADFRAMETYPE exceptions to trigger the EX line
0x60	Allows EX_BADCRC, EX_BADHEADER, EX_BADSEQID, EX_BADFRAMETYPE and EX_NORFACK exceptions to trigger the EX line
0xFF	Allows all exceptions to trigger the EX line

Figure 25: HumPRO™ Series Transceiver Example Exception Masks

The exception mask has no effect on the exceptions stored in the exception register. It only controls which exceptions affect the EX line.

The extended exception registers offer more functionality with more exceptions and a separate bit for each exception. These registers are the default and should be used with new applications.

The EX line is set and reset by the Extended Exception Flags (EEXFLAG) and Extended Exception Mask (EEXMASK) register processing. It is set whenever the EEXFLAG value ANDed with the EEXMASK value is non-zero. EX can change on any write to either of these registers that affects the result of ANDing the registers. Clearing an EEXFLAG register bit or value can leave EX set if there is another masked condition bit set.

The state of the EX line can also be read in the LSTATUS register, reducing the number of hardware lines that are required.

Carrier Sense Multiple Access (CSMA)

CSMA is an optional feature. It is a best-effort delivery system that listens to the channel before transmitting a message. If CSMA is enabled and the module detects another transmitter on the same channel, it waits until the active transmitter finishes before sending its payload. This helps to eliminate RF message corruption and make channel use more efficient.

When a module has data ready to transmit and CSMA is enabled, it listens on the intended transmit channel for activity. If no signal is detected, transmission is started.

If a carrier is detected with an RSSI above the CSMA threshold in the CRSSI register, transmission is inhibited. If a signal below the threshold is detected that has a compatible preamble or packet structure, transmission is also inhibited.

In these cases, the module waits for a random interval, then checks again for activity. If no activity is detected after waiting, it starts transmitting.

If the detected carrier lasts longer than the time allowed for the current channel, the module hops to the next channel in the hop sequence and again waits for a clear channel before transmitting.

Using the Buffer Empty (BE) Line

The BE line indicates the state of the module's UART buffer. It is high to indicate that the UART input buffer is empty, indicating that all data has been transmitted. When the module receives data in the CMD_DATA_IN line and the $\overline{\text{CMD}}$ line is high, the BE line is lowered until all data in the buffer has been processed by the protocol engine. If acknowledgement is not enabled, the BE line is raised as soon as the protocol engine processes the outgoing packets. If acknowledgement is enabled, the buffer is not updated until either the data transmissions are acknowledged by the remote end or delivery fails after the maximum number of retries. When the BE line returns high, the EX line may be sampled, or the EXCEPT or EEXFLAG register polled to determine if an error occurred during transmission.

The state of the BE line can be read in the LSTATUS register, reducing the number of hardware connections that are needed.

Using the Command Response ($\overline{\text{CRESP}}$) Line

The $\overline{\text{CRESP}}$ line is normally high, but the module lowers this line when responding to a UART command. This indicates to an external host microcontroller that the data on the CMD_DATA_OUT line is a response to a command and not data received over-the-air. $\overline{\text{CRESP}}$ is held in the correct state until one byte time after the last byte for the indicated source (command response or data).

The module normally outputs received RF data immediately following the command response. The $\overline{\text{CRESP}}$ line does rise before resuming RF data, but some microcontrollers cannot react quickly enough to this signal and may not be able to separate the command responses from RF data.

When configuring the module's register settings, it is possible for incoming RF data to intermix with the module's response to a configuration command. This can make it difficult to determine if commands were successfully processed as well as to capture the received RF data. Setting the CMDHOLD register to 0x01 causes the module to store incoming RF traffic (up to the RF buffer capacity) while the $\overline{\text{CMD}}$ line is low. When the $\overline{\text{CMD}}$ line is returned high, the module outputs the buffered data on the UART. This allows the external host microcontroller to have separate configuration times and data times instead of potentially having to handle both at once.

The $\overline{\text{CRESP}}$ line stays low for ten bit times after the stop bit of the last command response. Figure 26 shows the timing.



Figure 26: HumPRO™ Series Transceiver $\overline{\text{CRESP}}$ Line Timing

Using the $\overline{\text{CMD}}$ Line

The $\overline{\text{CMD}}$ line informs the module where incoming UART data should be routed. When the line is high, all incoming UART data is treated as payload data and is routed to the transmitter to be sent over the air. If the $\overline{\text{CMD}}$ line is low, the incoming UART data is treated as commands and is routed to the controller for processing.

Since the module's controller looks at UART data one byte at a time, the $\overline{\text{CMD}}$ line must be held low for the entire duration of the command plus time for ten bits as margin for processing. Leaving the line low for additional time (for example, until the ACK byte is received by the application) does not adversely affect the module. If RF packets are received while the $\overline{\text{CMD}}$ line is active, they are still processed and output on the module's UART. Figure 27 shows this timing.

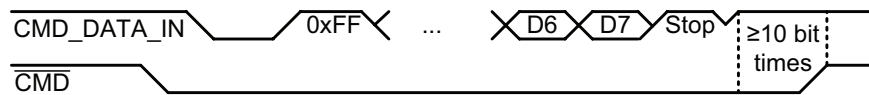

Figure 27: HumPRO™ Series Transceiver $\overline{\text{CMD}}$ Line Timing

Commands can be entered sequentially without having to raise the $\overline{\text{CMD}}$ line after each one. The $\overline{\text{CMD}}$ line just needs to be raised to be able to enter data for transmission.

If the CMDHOLD register is 0x01 then any received data is held until the $\overline{\text{CMD}}$ line is raised. This prevents received data from being intermingled with command responses.

External Amplifier Control

The HumPRO™ Series transceiver has two output lines that are designed to control external amplifiers. The PA_EN line goes high when the module activates the transmitter. This can be used to activate an external power amplifier to boost the signal strength of the transmitter. The LNA_EN line goes high when the module activates the receiver. This can be used to activate an external low noise amplifier to boost the receiver sensitivity. These external amplifiers can significantly increase the range of the system at the expense of higher current consumption and system cost.

The states of the PA_EN and LNA_EN lines can be read in the LSTATUS register. This offers a quick way to determine what state the radio is in.

AES Encryption

Encryption algorithms are complex mathematical equations that use a number, called a key, to encrypt data before transmission. This is done so that unauthorized persons who may intercept the transmission cannot access the data. In order to decrypt the transmission, the decoder must use the same key that was used to encrypt it. The decoder performs the same calculations as the encoder and, if the key is the same, the data is recovered.

The HumPRO™ Series module has the option to use AES encryption, arguably the most common encryption algorithm on the market. This is implemented in a secure mode of operation to ensure the secrecy of the transmitted data. It uses a 128-bit key stored in the NKEY registers to encrypt the transmitted data. The source and destination addresses are sent in the clear.

Encryption is disabled by default.

AES Encryption is not yet implemented on the HumPRO™ module.

Restore Factory Defaults

The transceiver is reset to factory default by taking the PB line high briefly 4 times, then holding PB high for more than 3 seconds. Each brief interval must be high 0.1 to 2 seconds and low 0.1 to 2 seconds. (1 second nominal high / low cycle). The sequence helps prevent accidental resets. Once the sequence is recognized, the RFACTV line blinks once per second until the PB line goes low. After PB goes low, the non-volatile configurations are set to the factory default values and the module is restarted. The default UART data rate is 9,600bps.

If the timing on PB does not match the specified limits, the sequence is ignored. Another attempt can be made after lowering PB for at least 3 seconds.

Using the Low Power Features

The module supports several low-power features to save current in battery-powered applications. This allows the module to be asleep most of the time, but be able to quickly wake up, send data and go back to sleep.

Taking the Power Down ($\overline{\text{POWER_DOWN}}$) line low places the module into the lowest power state. In this mode, the internal voltage regulator and all oscillators are turned off. All circuits powered from the voltage regulator are also off. The module is not functional while in this mode and current consumption drops to below 6 μ A. Taking the line high wakes the module.

When the $\overline{\text{POWER_DOWN}}$ line is high, the IDLE register determines sleep operation.

If IDLE is set to 1 during normal operation, the module sends an ACK byte, waits for completion of an active transmission, then goes into sleep mode. Unsent data in the incoming UART data buffer does not inhibit sleep. During sleep mode, the output lines are in the states in Figure 28.

A rising transition on the $\overline{\text{POWER_DOWN}}$ or CMD_DATA_IN lines wakes the module. If a negative-going pulse is needed to generate a rising edge, the pulse width should be greater than 1 μ s.

Other lines also wake the module but it immediately goes back to sleep. Floating inputs should be avoided since they may cause unintended transitions and cause the module to draw additional current. On wakeup, the CRESP line is taken high.

Output Line Sleep States	
Output Line	Sleep State
EX	Unchanged
$\overline{\text{CRESP}}$	Low
LNA_EN	Low
PA_EN	Low
TXD	High
$\overline{\text{CTS}}$	High
RFACTV	Low
BE	Unchanged

Figure 28: HumPRO™ Series Output Line Sleep States

If the volatile registers have been corrupted during sleep, a software reset is performed. This restarts the module as if power were cycled. This can be caused by power surges or brownout among other things.

After the module wakes up, it sets the IDLE register to 0 (active). If the WAKEACK register is set to 1, then the module outputs the 0x06 byte on the CMD_DATA_OUT line. The module then begins normal operation.

Pulsing $\overline{\text{RESET}}$ low causes the module to restart rather than continue from sleep.

The Command Data Interface

The HumPRO™ Series transceiver has a serial Command Data Interface (CDI) that is used to configure and control the transceiver through software commands. This interface consists of a standard UART with a serial command set. The CMD_DATA_IN and CMD_DATA_OUT lines are the interface to the module's UART. The UART is configured for 1 start bit, 1 stop bit, 8 data bits, no parity and a serial data rate set by register UARTBAUD (default 9,600bps). The $\overline{\text{CMD}}$ line tells the module if the data on the UART is for configuration commands (low) or data transmission (high).

The module has a 256 byte buffer for incoming data. The module starts transmitting when the buffer reaches a specified limit or when the time since the last received byte on the UART reaches a specified value. This allows the designer to optimize the module for fixed length and variable length data.

If the buffer gets nearly full (about 224 bytes), the module pulls the $\overline{\text{CTS}}$ line high, indicating that the host should not send any more data. Data sent by the host while the buffer is full is lost, so the $\overline{\text{CTS}}$ line provides a warning and should be monitored. When there is data in the UART receive buffer, the BE line is low; when this buffer is empty, BE is high.

Configuration settings are stored in two types of memory inside the module. Volatile memory is quick to access, but it is lost when power is removed from the module. Non-volatile memory takes longer to access, but is retained when power is removed. When a configuration parameter has both a non-volatile and volatile register, the volatile register controls the operation.

Configuration settings are read from non-volatile memory on power up and saved in volatile memory since it is faster to read and write the volatile memory locations. The volatile and non-volatile registers have different address locations, but the same read and write commands. The two locations can be changed independently.

The general serial command format for the module is:

[FF] [Length] [Command]

The Length byte is the number of bytes in the Command field. The Command field contains the register address that is to be accessed and, in the case of a write command, the value to be written. Neither Length nor Command can contain a 0xFF byte.

Byte values of 128 (0x80) or greater must be changed into a two-byte escape sequence of the format:

0xFE, [value - 0x80]

For example, the value 0x83 becomes 0xFE, 0x03. The Length count includes the added escape bytes.

A response is returned for all valid commands. The first response byte is CMD_ACK (0x06) or CMD_NACK (0x15). Additional bytes may follow, as determined by the specific command.

Writing to Registers

Byte values of 128 (0x80) or greater must be encoded into a two-byte escape sequence of the format 0xFE, [value - 0x80]. This includes register addresses as well as values to be written to the registers. The result is that there are four possible packet structures. These are shown in Figure 29.

HumPRO™ Series Write to Configuration Register Command					
Command for a Register and Value less than 128 (0x80)					
Header	Size	Address	Value		
0xFF	0x02	REG	V1		
Command for a Register less than 128 (0x80) and a Value greater than 128 (0x80)					
Header	Size	Address	Value 1	Value 2	
0xFF	0x03	REG	0xFE	V-0x80	
Command for a Register greater than 128 (0x80) and a Value less than 128 (0x80)					
Header	Size	Addr1	Addr2	Value	
0xFF	0x03	0xFE	REG-0x80	V1	
Command for a Register and Value greater than 128 (0x80)					
Header	Size	Addr1	Addr2	Value 1	Value 2
0xFF	0x04	0xFE	REG-0x80	0xFE	V-0x80

Figure 29: HumPRO™ Series Write to Configuration Register Command

Generally, there are three steps to creating the command.

1. Determine the register address and the value to be written.
2. Encode the address and value as either the number (N) or the encoded number (0xFE, N-0x80) as appropriate.
3. Add the header (0xFF) and the size.

The module responds with an ACK (0x06). If the ACK is not received, the command should be resent. The module responds with a NACK (0x15) if a write is attempted to a read-only or invalid register.

As an example, to write 01 to register 0x83, send

FF 03 FE 03 01

Note: The non-volatile memory has a life expectancy of at least 26,000 write operations.

Reading from Registers

A register read command is constructed by placing an escape character (0xFE) before the register number. The module responds by sending an ACK (0x06) followed by the register number and register value. The register value is sent unmodified, so if the register value is 0x83, 0x83 is returned. If the register number is invalid, the module responds with a NACK (0x15). The command and response are shown in Figure 30.

HumPRO™ Series Read From Configuration Register				
Command				
Header	Size	Escape	Address	
0xFF	0x02	0xFE	REG	
Response				
ACK	Address	Value		
0x06	REG	V1		
Command for an Address greater than 128 (0x80)				
Header	Size	Escape	Addr1	Addr2
0xFF	0x03	0xFE	0xFE	REG-80
Response				
ACK	Address	Value		
0x06	REG	V1		

Figure 30: HumPRO™ Series Read from Configuration Register Command and Response

The Command Data Interface Command Set

The following sections describe the registers.

Note: Values are shown in hexadecimal format unless otherwise stated.

HumPRO™ Series Configuration Registers					
Name	NV Addr	Vol Addr	R/W	Default Value	Description
CRCERRS		0x40	R/W	0x00	CRC Error Count
HOPTABLE	0x00	0x4B	R/W	0x00	Channel Hop Table
TXPWR	0x02	0x4D	R/W	0x03	Transmit Power
UARTBAUD	0x03	0x4E	R/W	0x01	UART data rate
ADDMODE	0x04	0x4F	R/W	0x04	Addressing mode
DATATO	0x05	0x50	R/W	0x10	Data timeout
MAXTXRETRY	0x07	0x52	R/W	0x1A	Maximum Transmit Retries
ENCRC	0x08	0x53	R/W	0x01	Enable CRC checking
BCTRIG	0x09	0x54	R/W	0x40	Byte Count trigger
SHOWVER	0x0A		R/W	0x01	Show version on startup
ENCSMA	0x0B	0x56	R/W	0x01	Enable CSMA
IDLE	0x0D	0x58	R/W	0x00	Idle Mode
WAKEACK	0x0E	0x59	R/W	0x01	UART Acknowledge on Wake
UDESTID3	0x0F	0x5A	R/W	0xFF	Destination Address for User Packet Type, extended
UDESTID2	0x10	0x5B	R/W	0xFF	Destination Address for User Packet Type, extended
UDESTID1	0x11	0x5C	R/W	0xFF	Destination Address for User Packet Type
UDESTID0	0x12	0x5D	R/W	0xFF	Destination Address for User Packet Type
USRCID3	0x13	0x5E	R/W	0xFF	Source Address for User Packet Type, extended
USRCID2	0x14	0x5F	R/W	0xFF	Source Address for User Packet Type, extended
USRCID1	0x15	0x60	R/W	0xFF	Source Address for User Packet Type
USRCID0	0x16	0x61	R/W	0xFF	Source Address for User Packet Type
UMASK3	0x17	0x62	R/W	0xFF	Address Mask for User Packet Type, extended
UMASK2	0x18	0x63	R/W	0xFF	Address Mask for User Packet Type, extended
UMASK1	0x19	0x64	R/W	0xFF	Address Mask for User Packet Type
UMASK0	0x1A	0x65	R/W	0xFF	Address Mask for User Packet Type
DESTDSN3	0x1D	0x68	R/W	0xFF	Destination Device Serial Number

DESTDSN2	0x1E	0x69	R/W	0xFF	Destination Device Serial Number
DESTDSN1	0x1F	0x6A	R/W	0xFF	Destination Device Serial Number
DESTDSN0	0x20	0x6B	R/W	0xFF	Destination Device Serial Number
EXMASK	0x21	0x6C	R/W	0x00	Exception Mask to activate EX
CMDHOLD	0x23	0x6E	R/W	0x00	Hold RF data when nCMD pin is low
COMPAT	0x25	0x70	R/W	0x02	Compatibility
AUTOADDR	0x26	0x71	R/W	0x00	Automatic Reply Address
MYDSN3	0x34		R		Factory programmed Serial Number
MYDSN2	0x35		R		Factory programmed Serial Number
MYDSN1	0x36		R		Factory programmed Serial Number
MYDSN0	0x37		R		Factory programmed Serial Number
CUSTID1	0x39		R	0xFF	Factory programmed customer ID
CUSTID0	0x3A		R	0xFF	Factory programmed customer ID
CRSSI	0x3F		R/W	0xBA	Carrier Sense minimum RSSI
RELEASE	0x78		R		Release number
EXCEPT		0x79	R	0x00	Exception code
PRSSI		0x7B	R	0x00	Packet RSSI
ARSSI		0x7C	R	0x00	Ambient RSSI
FWVER3		0xC0	R		Firmware version, major
FWVER2		0xC1	R		Firmware version, minor
FWVER1		0xC2	R		Firmware version, increment
FWVER0		0xC3	R		Firmware version, suffix
NVCYCLE1		0xC4	R		NV Erase Cycles, MS
NVCYCLE0		0xC5	R		NV Erase Cycles, LS
LSTATUS		0xC6	R		Output line status
CMD		0xC7	W		Command register
EEXFLAG2		0xCD	R/W	0x00	Extended exception flags
EEXFLAG1		0xCE	R/W	0x00	Extended exception flags
EEXFLAG0		0xCF	R/W	0x00	Extended exception flags
EEXMASK2	0x80	0xD0	R/W	0x00	Extended exception mask
EEXMASK1	0x81	0xD1	R/W	0x00	Extended exception mask
EEXMASK0	0x82	0xD2	R/W	0x00	Extended exception mask
PKTOPT	0x83	0xD3	R/W	0x00	Packet options

Figure 31: HumPRO™ Series Configuration Registers

CRCERRS - CRC Error Count

Volatile Address = 0x40

The value in the CRCERRS register is incremented each time a packet is received that fails the CRC check. Overflows are ignored. Writing 0x00 to this register initializes the count. Figure 32 shows the command and response.

HumPRO™ Series CRC Error Count						
Read Command				Read Response		
Header	Size	Escape	Address	ACK	Address	Value
0xFF	0x02	0xFE	0x40	0x06	0x40	V1
Write Command						
Header	Size	Address	Value			
0xFF	0x02	0x40	V1			

Figure 32: HumPRO™ Series CRC Error Count Command and Response

HOPTABLE - Channel Hop Table

Volatile Address = 0x4B; Non-Volatile Address = 0x00

The module supports 6 different hop sequences with minimal correlation. The sequence is set by the value in the HOPTABLE register. Changing the hop sequence changes the band utilization, much the same way that a channel does for a non-hopping transmitter. The hop table selection must match between the transmitter and receiver. Valid values are 0-5. Figure 33 shows the command and response.

HumPRO™ Series Channel Hop Table						
Read Command				Read Response		
Header	Size	Escape	Address	ACK	Address	Value
0xFF	0x02	0xFE	0x4B 0x00	0x06	0x4B 0x00	V1
Write Command						
Header	Size	Address	Value			
0xFF	0x02	0x4B 0x00	V1			

Figure 33: HumPRO™ Series Channel Hop Table Command and Response

Figure 34 shows the RF channels used by the HumPRO™ Series. When the baud rate is set to 9,600 or 19,200 bps, the module uses 50 hopping channels. Figure 35 shows the hop sequences referenced by channel

number. When the baud rate is 38,400bps and higher, the module uses 26 hopping channels. Figure 36 shows the hop sequences referenced by channel number. Only even channels are used. The default hop sequence is 0.

HumPRO™ Series RF Channels			
Channel Number	Frequency (MHz)	Channel Number	Frequency (MHz)
0	902.971	32	915.000
1	903.347	33	915.376
2	903.723	34	915.752
3	904.099	35	916.128
4	904.475	36	916.504
5	904.851	37	916.880
6	905.227	38	917.255
7	905.602	39	917.631
8	905.978	40	918.007
9	906.354	41	918.383
10	906.730	42	918.759
11	907.106	43	919.135
12	907.482	44	919.511
13	907.858	45	919.887
14	908.234	46	920.263
15	908.610	47	920.639
16	908.986	48	921.014
17	909.361	49	921.390
18	909.737	50	921.766
19	910.113	51	922.142
20	910.489	52	922.518
21	910.865	53	922.894
22	911.241	54	923.270
23	911.617	55	923.646
24	911.993	56	924.022
25	912.369	57	924.398
26	912.745	58	924.773
27	913.120	59	925.149
28	913.496	60	925.525
29	913.872	61	925.901
30	914.248	62	926.277
31	914.624	63	926.653

Figure 34: HumPRO™ Series RF Channels

HumPRO™ Series Hop Sequences by Channel Number for 19,200bps and below					
0	1	2	3	4	5
25	30	11	58	52	35
63	60	12	11	10	23
28	59	0	52	54	41
26	14	62	37	62	45
16	16	23	36	21	7
61	32	43	42	33	42
4	4	25	25	44	63
29	47	34	15	51	24
0	26	61	1	61	9
44	43	26	55	36	27
46	1	24	2	34	10
22	25	6	12	2	17
36	36	31	26	57	20
34	15	7	27	50	22
24	57	32	41	12	18
2	10	55	9	29	32
21	48	39	8	6	3
11	21	1	31	8	8
27	8	41	49	46	15
1	17	29	13	48	4
35	37	15	47	11	0
37	45	57	14	39	48
55	44	3	33	4	13
8	13	42	48	45	61
10	33	47	38	22	31
54	0	2	45	56	56
13	46	56	59	18	52
32	62	33	3	43	54
43	34	9	46	60	55
12	7	14	0	31	62
23	24	30	39	47	6
48	22	21	57	0	37
14	58	4	56	20	36
39	42	54	5	37	38
40	50	59	40	59	51
15	12	51	23	35	59
57	20	22	62	7	5
18	39	38	24	15	43
60	27	58	54	25	21
41	2	60	17	16	40
9	35	52	22	23	14
49	5	45	32	42	12
58	28	37	7	24	30
38	49	13	61	32	16
45	29	35	34	28	34
56	18	36	63	26	46
50	38	8	50	13	60
42	3	46	30	3	39
62	52	40	43	5	58
47	40	49	28	49	33

Figure 35: HumPRO™ Series Hop Sequences for UART rate of 9,600bps

HumPRO™ Series Hop Sequences by Channel Number for 38,400bps and Above					
0	1	2	3	4	5
32	30	6	56	44	18
2	60	40	22	14	48
4	58	42	20	16	46
10	52	48	14	22	40
20	42	58	4	32	30
42	20	16	46	54	8
22	40	60	2	34	28
46	16	20	42	58	4
28	34	2	60	40	22
58	4	32	30	6	56
54	8	28	34	2	60
44	18	18	44	56	6
24	38	62	0	36	26
48	14	22	40	60	2
34	28	8	54	46	16
6	56	44	18	18	44
14	48	52	10	26	36
30	32	4	58	42	20
62	0	36	26	10	52
60	2	34	28	8	54
56	6	30	32	4	58
50	12	24	38	62	0
38	24	12	50	50	12
12	50	50	12	24	38
26	36	0	62	38	24
52	10	26	36	0	62

Figure 36: HumPRO™ Series Hop Sequences for UART rates of 19,200bps and above

TXPWR - Transmitter Output Power

Volatile Address = 0x4D; Non-Volatile Address = 0x02

The value in the TXPWR register sets the module's output power. Figure 37 shows the command and response and Figure 38 available power settings and typical power outputs for the module. The default setting is 0x03.

HumPRO™ Series Transmitter Output Power Mode						
Read Command				Read Response		
Header	Size	Escape	Address	ACK	Address	Value
0xFF	0x02	0xFE	0x4D 0x02	0x06	0x4D 0x02	PWR
Write Command						
Header	Size	Address	Value			
0xFF	0x02	0x4D 0x02	PWR			

Figure 37: HumPRO™ Series Transmitter Output Power Mode Command and Response

HumPRO™ Series Transmitter Output Power Mode Register Settings	
PWR	Typical Output Power (dBm)
0x00	-5
0x01	0
0x02	+5
0x03	+9

Figure 38: HumPRO™ Series Transmitter Output Power Mode Settings

UARTBAUD - UART Baud Rate

Volatile Address = 0x4E; Non-Volatile Address = 0x03

The value in UARTBAUD sets the data rate of the UART interface. Changing the non-volatile register changes the data rate on the following power-up or reset. Changing the volatile register changes the data rate immediately following the command acknowledgement. Figure 39 shows the command and response and Figure 40 shows the valid settings.

HumPRO™ Series UART Baud Rate						
Read Command				Read Response		
Header	Size	Escape	Address	ACK	Address	Value
0xFF	0x02	0xFE	0x4E 0x03	0x06	0x4E 0x03	V1
Write Command						
Header	Size	Address	Value			
0xFF	0x02	0x4E 0x03	V1			

Figure 39: HumPRO™ Series UART Baud Rate Command and Response

HumPRO™ Series UART Baud Rate Register Settings		
V1	Baud Rate (bps)	RF Data Rate (bps)
0x01	9,600	19,200
0x02	19,200	19,200
0x03	38,400	153,600
0x04	57,600	153,600
0x05	115,200	153,600
0x06	10,400*	153,600
0x07	31,250*	153,600

* These data rates are not supported by PC serial ports. Selection of these rates may cause the module to fail to respond to a PC, requiring a reset to factory defaults.

Figure 40: HumPRO™ Series UART Baud Rate Settings

If the module's UART baud rate is different than the host processor UART baud rate then the module will not communicate correctly. If mismatched, every rate can be tested until the correct one is found or the module can be reset to factory defaults. The default baud rate is 9,000bps (0x01).

ADDMODE - Addressing Mode

Volatile Address = 0x4F; Non-Volatile Address = 0x04

The module supports three addressing modes: DSN, User, and Extended User, which are configured using bits 0 - 2. For each of these modes, assured delivery (acknowledgement) can be either enabled or disabled.

If bit 3 is set, the module sends an extended preamble. This allows modules that have just awakened or have not yet synchronized to find and temporarily synchronize with the transmitting module. This can be useful in systems that require the endpoints to spend most of their time sleeping. Endpoints can awaken, receive a message from the transmitter, and go back to sleep. This message could contain scheduling information as to when to wake again for a full bi-directional communications session.

Figure 41 shows the command and response and Figure 42 shows the valid settings.

HumPRO™ Series Addressing Mode							
Read Command				Read Response			
Header	Size	Escape	Address	ACK	Address	Value	
0xFF	0x02	0xFE	0x4F 0x04	0x06	0x4F 0x04	V1	
Write Command							
Header	Size	Address	Value				
0xFF	0x02	0x4F 0x04	V1				

Figure 41: HumPRO™ Series Addressing Mode Command and Response

HumPRO™ Series Addressing Mode Register Settings	
Addressing Mode	Meaning
0x04	DSN Addressing Mode
0x06	User Addressing Mode
0x07	Extended User Addressing Mode
0x14	DSN Addressing Mode with Acknowledgement
0x16	User Addressing Mode with Acknowledgement
0x17	Extended User Addressing Mode with Acknowledgement
+0x00	Send normal preamble
+0x08	Send extended preamble

All other addressing modes are reserved and may cause undesired operation.

Figure 42: HumPRO™ Series Addressing Mode Register Settings

DATATO - Transmit Wait Timeout

Volatile Address = 0x50; Non-Volatile Address = 0x05

When a byte is received from the UART, the module starts a timer that counts down every millisecond. The timer is restarted when each byte is received. The value for the DATATO register is the number of milliseconds to wait before transmitting the data in the UART receive buffer. The default setting for this register is 0x10 (~16ms delay).

If the timer reaches zero before the next byte is received from the UART, the module begins transmitting the data in the buffer. This timeout value should be greater than one byte time at the current UART baud rate with a minimum of 0x02. It should not be set any value less than one byte time as unpredictable results could occur.

If the timeout value is set to 0x00, the transmit wait timeout is deactivated. In this case, the transceiver waits until a number of bytes equal to the UART Byte Count Trigger have been received by the UART. All of the bytes are sent once the trigger has been reached. Figure 43 shows examples of the commands. Figure 44 shows the minimum timeout values based on baud rate.

HumPRO™ Series Transmit Wait Timeout							
Read Command				Read Response			
Header	Size	Escape	Address	ACK	Address	Value	
0xFF	0x02	0xFE	0x50 0x05	0x06	0x50 0x05	V1	
Write Command							
Header	Size	Address	Value				
0xFF	0x02	0x50 0x05	V1				

Figure 43: HumPRO™ Series Transmit Wait Timeout Command and Response

HumPRO™ Series Minimum DATATO Values	
Baud Rate	Minimum DATATO
9,600	3ms
19,200	2ms
38,400	2ms
57,600	2ms
115,200	2ms

Figure 44: HumPRO™ Series Transmit Wait Timeout Minimum Values

MAXTXRETRY - Maximum Transmit Retries

Volatile Address = 0x52; Non-Volatile Address = 0x07

The value in the MAXTXRETRY register sets the number of transmission retries if an acknowledgement is not received. If an acknowledgement is not received after the last retry, exception EX_NORFACK is raised. Figure 45 shows examples of the command.

HumPRO™ Series Maximum Transmit Retries							
Read Command				Read Response			
Header	Size	Escape	Address	ACK	Address	Value	
0xFF	0x02	0xFE	0x52 0x07	0x06	0x52 0x07	V1	
Write Command							
Header	Size	Address	Value				
0xFF	0x02	0x52 0x07	V1				

Figure 45: HumPRO™ Series Maximum Transmit Retries Command and Response

The time between retries depends on the current baud rate. Figure 46 shows the time between retries based on baud rate. The elapsed transmit and acknowledgment time is $(\text{retries} + 1) * (\text{PacketTransmitTime} + \text{Timeout})$.

HumPRO™ Series Acknowledgement Timeout Times	
Baud Rate	Timeout Time
9,600	50ms
19,200	50ms
38,400	30ms
57,600	30ms
115,200	30ms

Figure 46: HumPRO™ Series Acknowledgement Timeout Times

ENCRC - CRC Enable

Volatile Address = 0x53; Non-Volatile Address = 0x08

The protocol includes a Cyclic Redundancy Check (CRC) on the received packets to make sure that there are no errors. Any packets with errors are discarded and not output on the UART. This feature can be disabled if it is desired to perform error checking outside the module. Set the ENCRC register to 0x01 to enable CRC checking, or 0x00 to disable it. The default CRC mode setting is enabled. Figure 47 shows examples of the commands and Figure 48 shows the available values.

HumPRO™ Series CRC Enable							
Read Command				Read Response			
Header	Size	Escape	Address	ACK	Address	Value	
0xFF	0x02	0xFE	0x53 0x08	0x06	0x53 0x08	V1	
Write Command							
Header	Size	Address	Value				
0xFF	0x02	0x53 0x08	V1				

Figure 47: HumPRO™ Series CRC Enable Command and Response

HumPRO™ Series CRC Enable Register Settings	
V1	Mode
0x00	CRC Disabled
0x01	CRC Enabled

Figure 48: HumPRO™ Series CRC Enable Register Settings

Although disabling CRC checking allows receiving packets with errors in the payload, errors in the header can still prevent packets from being output by the module.

BCTRIG - UART Byte Count Trigger

Volatile Address = 0x54; Non-Volatile Address = 0x09

The BCTRIG register determines the UART buffer level that triggers the transmission of a packet. The minimum value is decimal 1 and the maximum value is 192. The default value for this register is 64, which provides a good mix of throughput and latency. At the maximum data rate, a value of 128 optimizes throughput. This register does not guarantee a particular transmission unit size; rather, it specifies the minimum desired size. If there is not enough time left in the channel dwell time before the module must hop to the next channel, for instance, the protocol engine sends as many characters as it can to fill the current channel dwell time, and sends the remaining characters on the next channel. Figure 49 shows examples of the commands.

HumPRO™ Series UART Byte Count Trigger						
Read Command				Read Response		
Header	Size	Escape	Address	ACK	Address	Value
0xFF	0x02	0xFE	0x54 0x09	0x06	0x54 0x09	V1
Write Command						
Header	Size	Address	Value			
0xFF	0x02	0x54 0x09	V1			

Figure 49: HumPRO™ Series UART Byte Count Trigger Command and Response

This trigger can be overridden by enabling the TXPKT option (PKTOPT register, bit 0).

SHOWVER - Show Version

Non-Volatile Address = 0x0A

Setting the SHOWVER register to 0x00 suppresses the start-up message, including firmware version, which is sent out of the UART when the module is reset. A value of 0x01 causes the message to be output after reset. By default, the module start-up message is output. Figure 50 shows examples of the commands and Figure 51 shows the available values.

HumPRO™ Series Show Version						
Read Command				Read Response		
Header	Size	Escape	Address	ACK	Address	Value
0xFF	0x02	0xFE	0x0A	0x06	0x0A	V1
Write Command						
Header	Size	Address	Value			
0xFF	0x02	0x0A	V1			

Figure 50: HumPRO™ Series Show Version Command and Response

HumPRO™ Series Show Version Register Settings	
V1	Meaning
0x00	Startup message is NOT output on reset or power-up.
0x01	Startup message is output on reset or power-up. This is a blocking operation, and any incoming UART data is lost during the transmission of this message through the CMD_DATA_OUT line. All UART commands must be sent after this message has completed.
0x02	Startup message is displayed upon reset or power-up. This is a non-blocking operation. Any incoming UART data is buffered, and incoming UART commands are processed. If a change of baud rate is commanded while the startup message is being output, the current byte finishes at the current baud rate, and subsequent bytes are transmitted at the new baud rate.

Figure 51: HumPRO™ Series Show Version Register Settings

Example:

HUM-900-PRO v1.2.3

(C) 2014 Linx Technologies Inc. All rights reserved.

ENCSMA - CSMA Enable

Volatile Address = 0x56; Non-Volatile Address = 0x0B

Carrier-Sense Multiple Access (CSMA) is a best-effort transmission protocol that listens to the channel before transmitting a message. If another HumPRO™ module is already transmitting on the same channel at the same baud rate when a message is ready to send, the module waits before sending its payload. This helps to eliminate RF message corruption at the expense of additional latency. By default, CSMA is enabled. Figure 52 shows examples of the commands and Figure 53 shows the available values.

HumPRO™ Series CSMA Enable							
Read Command				Read Response			
Header	Size	Escape	Address	ACK	Address	Value	
0xFF	0x02	0xFE	0x56 0x0B	0x06	0x56 0x0B	V1	
Write Command							
Header	Size	Address	Value				
0xFF	0x02	0x56 0x0B	V1				

Figure 52: HumPRO™ Series CSMA Enable Command and Response

HumPRO™ Series CSMA Enable Register Settings	
V1	Mode
0x00	Disable CSMA
0x01	Enable CSMA

Figure 53: HumPRO™ Series CSMA Enable Register Settings

The module only checks for other HumPRO™ modules. It does not defer to transmissions from other systems.

IDLE - Idle Mode

Volatile Address = 0x58; Non-Volatile Address = 0x0D

The value in the IDLE register sets the operating mode of the transceiver. If the module remains properly powered, and is awakened from a low power mode properly, the volatile registers retain their values. If the volatile registers become corrupted during low power, a software reset is forced and the module reboots.

Awake is the normal operating setting. This is the only setting in which the RF circuitry is able to receive and transmit RF messages.

Sleep disables all circuitry on-board the module. This is the lowest-power setting available for the module.

Please see the Low Power States section for more details. Figure 54 shows examples of the commands and Figure 55 shows the available values.

HumPRO™ Series Idle Mode							
Read Command				Read Response			
Header	Size	Escape	Address	ACK	Address	Value	
0xFF	0x02	0xFE	0x58 0x0D	0x06	0x58 0x0D	V1	
Write Command							
Header	Size	Address	Value				
0xFF	0x02	0x58 0x0D	V1				

Figure 54: HumPRO™ Series Idle Mode Command and Response

HumPRO™ Series Idle Mode Register Settings	
V1	Mode
0x00	Awake
0x01	Sleep

Figure 55: HumPRO™ Series Idle Mode Register Settings

WAKEACK - ACK on Wake

Volatile Address = 0x59; Non-Volatile Address = 0x0E

When UART Acknowledge on Wake is enabled, the module sends an ACK (0x06) character out of the CMD_DATA_OUT line after the module wakes. If the SHOWVER register is 1, the ACK is sent after the firmware version. This indicates that the module is ready to accept data and commands. A value of 0x01 enables this feature; 0x00 disables it. The default value is 0x01. Figure 56 shows examples of the commands and Figure 57 shows the available values.

HumPRO™ Series ACK on Wake						
Read Command				Read Response		
Header	Size	Escape	Address	ACK	Address	Value
0xFF	0x02	0xFE	0x59 0x0E	0x06	0x59 0x0E	V1
Write Command						
Header	Size	Address	Value			
0xFF	0x02	0x59 0x0E	V1			

Figure 56: HumPRO™ Series ACK on Wake Command and Response

HumPRO™ Series ACK on Wake Register Settings	
V1	Mode
0x00	Disable ACK
0x01	Enable ACK

Figure 57: HumPRO™ Series ACK on Wake Register Settings

UDESTID - User Destination Address

Volatile Address = 0x5A-0x5D; Non-Volatile Address = 0x0F-0x12

These registers contain the address of the destination module when User Addressing mode or Extended User Addressing mode are enabled. User Addressing mode uses bytes 0 and 1 to determine the destination address. Extended User Addressing mode uses all four bytes. When the COMPAT register is 0x02 in User Address mode, bytes 3 and 2 must be 0. These registers are automatically filled with the source address from a received message if AUTOADDR = 1. Please see the Addressing Modes section for more details. Each register byte is read and written separately. Figure 58 shows the User Destination ID registers.

HumPRO™ Series User Destination Address Registers			
Name	Volatile Address	Non-Volatile Address	Description
UDESTID3	0x5A	0x0F	MSB of the extended destination address
UDESTID2	0x5B	0x10	Byte 2 of the extended destination address
UDESTID1	0x5C	0x11	Byte 1 of the extended destination address, MSB of the short destination address
UDESTID0	0x5D	0x12	LSB of the extended destination address and short destination address

Figure 58: HumPRO™ Series User Destination Address Registers

USRCID - User Source Address

Volatile Address = 0x5E-0x61; Non-Volatile Address = 0x13-0x16

These registers contain the address of the module when User Addressing mode or Extended User Addressing mode are enabled. User Addressing mode uses bytes 0 and 1 to determine the source address. Extended User Addressing mode uses all four bytes. Please see the Addressing Modes section for more details. Each register byte is read and written separately. Figure 59 shows the User Source ID registers.

HumPRO™ Series User Source Address Registers			
Name	Volatile Address	Non-Volatile Address	Description
USRCID3	0x5E	0x13	MSB of the extended source address
USRCID2	0x5F	0x14	Byte 2 of the extended source address
USRCID1	0x60	0x15	Byte 1 of the extended source address, MSB of the short source address
USRCID0	0x61	0x16	LSB of the extended source address and short source address

Figure 59: HumPRO™ Series User Source Address Registers

UMASK - User ID Mask

Volatile Address = 0x62-0x65; Non-Volatile Address = 0x17-0x1A

These registers contain the user ID mask when User Addressing mode or Extended User Addressing mode are enabled. Please see the Addressing Modes section for more details. Each register byte is read and written separately.

Figure 60 shows the User ID Mask registers.

HumPRO™ Series User ID Mask Registers			
Name	Volatile Address	Non-Volatile Address	Description
UMASK3	0x62	0x17	MSB of the extended mask
UMASK2	0x63	0x18	Byte 2 of the extended mask
UMASK1	0x64	0x19	Byte 1 of the extended mask MSB of the short mask
UMASK0	0x65	0x1A	LSB of the extended mask and short mask

Figure 60: HumPRO™ Series User ID Mask Registers

DESTDSN - Destination Serial Number

Volatile Address = 0x68-0x6B; Non-Volatile Address = 0x1D-0x20

These registers contain the serial number of the destination module when DSN Addressing Mode is enabled. Please see the Addressing Modes section for more details. Each register byte is read and written separately.

Figure 61 shows the Destination DSN registers.

HumPRO™ Series Destination DSN Registers			
Name	Volatile Address	Non-Volatile Address	Description
DESTDSN3	0x68	0x1D	MSB of the destination DSN
DESTDSN2	0x69	0x1E	Byte 2 of the destination DSN
DESTDSN1	0x6A	0x1F	Byte 1 of the destination DSN MSB of the short destination DSN
DESTDSN0	0x6B	0x20	LSB of the extended and short DSN

Figure 61: HumPRO™ Series Destination DSN Registers

EXMASK - Exception Mask

Volatile Address = 0x6C; Non-Volatile Address = 0x21

The module has a built-in exception engine that can notify the host processor of an unexpected event. When an exception occurs, this register is ANDed with the exception code. A non-zero result causes the EX line to go high. Reading the EXCEPT register clears the exception and resets the EX line. If the ANDed result is zero, the EX line is not asserted but the exception code is stored in the EXCEPT register.

Figure 62 shows examples of the commands and Figure 63 shows the available values.

HumPRO™ Series Exception Mask						
Read Command				Read Response		
Header	Size	Escape	Address	ACK	Address	Value
0xFF	0x02	0xFE	0x6C 0x21	0x06	0x6C 0x21	V1
Write Command						
Header	Size	Address	Value			
0xFF	0x02	0x6C 0x21	V1			

Figure 62: HumPRO™ Series Transceiver Exception Mask Command and Response

HumPRO™ Series Example Exception Masks	
V1	Exception Name
0x08	Allows only EX_BUFOVFL and EX_RFOVFL to trigger the EX line
0x10	Allows only EX_WRITEREGFAILED to trigger the EX line
0x20	Allows only EX_NORFACK to trigger the EX line
0x40	Allows only EX_BADCRC, EX_BADHEADER, EX_BADSEQID and EX_BADFRAMETYPE exceptions to trigger the EX line
0x60	Allows EX_BADCRC, EX_BADHEADER, EX_BADSEQID, EX_BADFRAMETYPE and EX_NORFACK exceptions to trigger the EX line
0xFF	Allows all exceptions to trigger the EX line

Figure 63: HumPRO™ Series Transceiver Example Exception Masks

CMDHOLD - $\overline{\text{CMD}}$ Halts Traffic

Volatile Address = 0x6E; Non-Volatile Address = 0x23

When configuring the module's register settings, it is possible that incoming RF data can intermix with the module's response, making it difficult to separate command responses and data bytes. A CMDHOLD register setting of 0x01 causes the module to store incoming RF traffic (up to the RF buffer size) while the $\overline{\text{CMD}}$ line is low. When the $\overline{\text{CMD}}$ line is returned high, the module outputs all buffered data. A register value of 0 allows received bytes to be output on the UART immediately with $\overline{\text{CRESP}}$ high to indicate that the bytes are received data. The external host processor must distinguish the command response bytes from the received data bytes by using the $\overline{\text{CRESP}}$ line.

Figure 64 shows examples of the commands and Figure 65 shows the available values.

HumPRO™ Series $\overline{\text{CMD}}$ Halts Traffic						
Read Command				Read Response		
Header	Size	Escape	Address	ACK	Address	Value
0xFF	0x02	0xFE	0x6E 0x23	0x06	0x6E 0x23	V1
Write Command						
Header	Size	Address	Value			
0xFF	0x02	0x6E 0x23	V1			

Figure 64: HumPRO™ Series Transceiver $\overline{\text{CMD}}$ Halts Traffic Command and Response

HumPRO™ Series $\overline{\text{CMD}}$ Halts Traffic Register Settings	
V1	Mode
0x00	Disable Halt (received data is sent to the UART immediately)
0x01	Enable Halt (received data is sent when the $\overline{\text{CMD}}$ line is high)

Figure 65: HumPRO™ Series $\overline{\text{CMD}}$ Halts Traffic Register Settings

COMPAT - Compatibility Mode

Volatile Address = 0x70; Non-Volatile Address = 0x25

Compatibility mode allows the HumPRO™ Series modules to communicate with the 250 Series modules. Please see the Compatibility Mode section for more details. Figure 66 shows examples of the commands and Figure 67 shows the available values.

HumPRO™ Series Compatibility Mode						
Read Command				Read Response		
Header	Size	Escape	Address	ACK	Address	Value
0xFF	0x02	0xFE	0x70 0x25	0x06	0x70 0x25	V1
Write Command						
Header	Size	Address	Value			
0xFF	0x02	0x70 0x25	V1			

Figure 66: HumPRO™ Series Transceiver Compatibility Mode Command and Response

HumPRO™ Series Compatibility Mode Register Settings	
V1	Mode
0x00	Enable 250 Series Compatibility Mode
0x02	Enable normal Addressing Operation

Figure 67: HumPRO™ Series Compatibility Mode Register Settings

AUTOADDR - Auto Addressing

Volatile Address = 0x71; Non-Volatile Address = 0x26

When the AUTOADDR feature is enabled, the module reads the Source Address from a received packet and uses it to fill the Destination Address registers (UDESTID or DESTDSN, depending on the addressing mode of the received message). This ensures that a response is sent to the device that transmitted the original message. The response ADDMODE should be the same as ADDMODE used to send the original message.

The non-volatile register only uses the lower 4 bits to configure the automatic addressing. The upper 4 bits are not used.

The volatile register is split in half with the lower 4 bits configuring the automatic addressing, the same as the non-volatile register. The upper 4 bits indicate the type of packet that was last received. This indication is the

same as the Addressing Mode register setting. These bits are not used by the module and are only written by the module after successfully receiving a packet.

As an example, if AUTOADDR is set to 0x0F (Any Auto Address) and a DSN packet is received from another module, then AUTOADDR reads back as 0x4F. The lower 4 bits (0xF) indicate that the module is set to any auto address (0xF). The upper 4 bits (0x4) indicate that the packet that was just received was a DSN Addressing Mode packet.

Figure 68 summarizes the configuration values for the lower 4 bits of the register.

HumPRO™ Series Auto Addressing Register Settings		
Auto Address Value	Meaning	Action
0x00	Auto Addressing disabled	Destination Registers not populated
0x04	DSN Auto Address	Auto-populates DSN Address Destination Register Only
0x06	User Auto Address Mode	Auto-populates User Address Destination Register
0x07	Extended User Auto Address Mode	Auto-populates Extended User Address Destination Register
0x0F	Any Auto Address Mode	Auto-populates any Address Destination Register

Figure 68: HumPRO™ Series Transceiver Auto Addressing Register Settings

Figure 69 shows the Addressing Mode values that the module writes to the upper 4 bits after successfully receiving a packet.

HumPRO™ Series Auto Addressing Mode Indicator	
Addressing Mode	Meaning
0x4	DSN Addressing Mode
0x6	User Addressing Mode
0x7	Extended User Addressing Mode

Figure 69: HumPRO™ Series Transceiver Auto Addressing Mode Indicator

MYDSN - Local Device Serial Number

Non-Volatile Address = 0x34-0x37

These registers contain the factory-programmed read-only Device Serial Number. This address is unique for each module and is used by all packet types as a unique origination address.

Figure 70 shows the Device Serial Number registers.

HumPRO™ Series DSN Registers		
Name	Non-Volatile Address	Description
MYDSN3	0x34	MSB of the serial number
MYDSN2	0x35	Byte 2 of the serial number
MYDSN1	0x36	Byte 1 of the serial number
MYDSN0	0x37	LSB of the serial number

Figure 70: HumPRO™ Series DSN Registers

CUSTID - Customer ID

Non-Volatile Address = 0x39-0x3A

These registers contain the factory-programmed customer ID. A unique value is assigned to a specific customer and that value is programmed into that customer's modules. The User and Extended User Addressing modes use these bytes as part of the addressing. The unique value ensures that the custom modules will not communicate with any other systems. Contact Linx for details. Figure 71 shows the Customer ID registers.

HumPRO™ Series Customer ID Registers		
Name	Non-Volatile Address	Description
CUSTID1	0x39	MSB of the customer ID
CUSTID0	0x3A	LSB of the customer ID

Figure 71: HumPRO™ Series Transceiver Customer ID Registers

CRSSI - Carrier Sense Minimum RSSI

Non-Volatile Address = 0x3F

This value is the minimum RSSI that causes the module to wait for a clear channel when CSMA is enabled. Figure shows examples of the commands.

HumPRO™ Series Carrier Sense Minimum RSSI									
Read Command				Read Response					
Header	Size	Escape	Address	ACK	Address	Value			
0xFF	0x02	0xFE	0x3F	0x06	0x3F	V1			
Write Command									
Header	Size	Address	Value						
0xFF	0x02	0x3F	V1						

Figure 72: HumPRO™ Series Transceiver Carrier Sense Minimum RSSI Command and Response

The value is a negative number in two's complement from -128 (0x80) to -1 (0xff). The default value is -70dBm.

RELEASE - Release Number

Non-Volatile Address = 0x78

This register contains a number designating the firmware version and hardware platform. Figure 73 shows examples of the commands and Figure 74 lists current releases to date.

HumPRO™ Series Release Number									
Read Command				Read Response					
Header	Size	Escape	Address	ACK	Address	Value			
0xFF	0x02	0xFE	0x78	0x06	0x78	V1			

Figure 73: HumPRO™ Series Transceiver Release Number Command and Response

HumPRO™ Series Release Number Register Settings	
V1	Release Number
0x20	HUM-900-PRO

Figure 74: HumPRO™ Series Transceiver Release Number Register Settings

A more detailed firmware version is available for versions 0x20 and above in the FWER register.

EXCEPT - Exception Code

Volatile Address = 0x79

The module has a built-in exception engine that can notify the host processor of an unexpected event. If an exception occurs, the exception code is stored in this register. Reading from this register clears the exception and resets the EX line. If an exception occurs before the previous exception code is read, the previous value is overwritten. Figure 75 shows examples of the commands and Figure 76 shows the available values.

HumPRO™ Series Exception Code									
Read Command				Read Response					
Header	Size	Escape	Address	ACK	Address	Value			
0xFF	0x02	0xFE	0x79	0x06	0x79	V1			

Figure 75: HumPRO™ Series Transceiver Exception Code Command and Response

HumPRO™ Series Transceiver Exception Codes		
V1	Exception Name	Description
0x08	EX_BUFOVFL	Internal UART buffer overflowed.
0x09	EX_RFOVFL	Internal RF packet buffer overflowed.
0x13	EX_WRITEREGFAILED	Attempted write to register failed.
0x20	EX_NOACK	Acknowledgement packet not received after maximum number of retries.
0x40	EX_BADCRC	Bad CRC detected on incoming packet.
0x42	EX_BADHEADER	Bad CRC detected in packet header.
0x43	EX_BADSEQID	Sequence ID was incorrect in ACK packet.
0x44	EX_BADFRAMETYPE	Unsupported frame type specified.

Figure 76: HumPRO™ Series Transceiver Exception Codes

PRSSI - Last Good Packet RSSI

Volatile Address = 0x7B

This register holds the received signal strength in dBm of the last successfully received packet. A successful packet reception is one that causes payload data to be output on the UART interface. The value in this register is overwritten each time a new packet is successfully processed. The register value is an 8-bit signed integer representing the RSSI in dBm. It is accurate to ± 3 dB.

HumPRO™ Series Last Good Packet RSSI							
Read Command				Read Response			
Header	Size	Escape	Address	ACK	Address	Value	
0xFF	0x02	0xFE	0x7B	0x06	0x7B	V1	

Figure 77: HumPRO™ Series Transceiver Last Good Packet RSSI Command and Response

ARSSI - Ambient RSSI

Volatile Address = 0x7C

This register returns the ambient receive signal strength on the current channel in dBm. The signal strength is measured as soon as the command is received. The register value is an 8-bit signed integer representing the RSSI in dBm. It is accurate to ± 3 dB.

HumPRO™ Series Ambient RSSI							
Read Command				Read Response			
Header	Size	Escape	Address	ACK	Address	Value	
0xFF	0x02	0xFE	0x7C	0x06	0x7C	V1	

Figure 78: HumPRO™ Series Transceiver Ambient RSSI Command and Response

FWVER - Firmware Version

Non-Volatile Address = 0xC0 - 0xC3

These read-only registers contain the firmware version number currently on the module. Each byte is a hexadecimal value: 12 03 01 00 indicates version 18.3.1.0. Each register byte is read and written separately. Figure 79 shows the Firmware Version registers.

HumPRO™ Series Firmware Version Registers		
Name	Non-Volatile Address	Description
FWVER3	0xC0	Major version number
FWVER2	0xC1	Minor version number
FWVER1	0xC2	Incremental version number
FWVER0	0xC3	Suffix

Figure 79: HumPRO™ Series Firmware Version Registers

NVCYCLE - Non-Volatile Erase Cycles

Non-Volatile Address = 0xC4-0xC5

These read-only non-volatile registers contain the number of lifetime erase cycles performed for the non-volatile memory. The minimum lifetime erases is 2,000 erase cycles. Beyond this the erases may not be complete and the module's operation can become unpredictable.

HumPRO™ Series Non-Volatile Erase Cycles Registers		
Name	Non-Volatile Address	Description
NVCYCLE1	0xC4	MSB of the number of erase cycles
NVCYCLE0	0xC5	LSB of the number of erase cycles

Figure 80: HumPRO™ Series Non-Volatile Erase Cycles Registers

Between 13 and 158 non-volatile write operations can be made before an erase cycle is necessary. Writing the registers from lowest to highest maximizes the number of write operations.

It is recommended to write the desired default values to non-volatile memory and use the volatile registers for values that change frequently.

These registers show the total number of erase cycles that have occurred. This gives an indication of the remaining life expectancy of the memory. Figure 80 shows the Non-Volatile Erase Cycles registers.

LSTATUS - Output Line Status

Volatile Address = 0xC6

This register contains the logic states of the output indicator lines, providing information to the host processor while using fewer GPIO lines.

HumPRO™ Series Output Line Status								
Read Command					Read Response			
Header	Size	Escape	Escape	Address	ACK	Address	Value	
0xFF	0x03	0xFE	0xFE	0x46	0x06	0xC6	LSTATUS	

Figure 81: HumPRO™ Series Transceiver Output Line Status Command and Response

Each bit in the byte that is returned by the read represents the logic state of one of the output indicator lines. Figure 82 shows which line each bit represents.

HumPRO™ Series Output Line Status LSTATUS Values	
LSTATUS Bit	Line Status
0	EX – Exception, 1 = exception has occurred
1	PA_EN – PA Enable, 1 = the transmitter is active
2	LNA_EN – LNA Enable, 1 = the receiver is active
3	$\overline{\text{CTS}}$ – Clear To Send, 1 = incoming data buffer near full
4	RFACTV – RF Active, 1 = RF data transfer is active (TX or RX)
5	BE – Buffer Empty, 1 = UART buffer is empty
6	Reserved
7	Reserved

Figure 82: HumPRO™ Series Output Line Status LSTATUS Values

CMD - Command Register

Volatile Address = 0xC7

This volatile write-only register is used to issue special commands.

HumPRO™ Series Command Register				
Write Command				
Header	Size	Escape	Address	Value
0xFF	0x03	0xFE	0x47	V1

Figure 83: HumPRO™ Series Transceiver Command Register Command and Response

Value V1 is chosen from among the options in Figure 84.

HumPRO™ Series CMD Values	
CMD Value	Operation
0x1	SENDP – Send Packet
0x2	GETPH – Get Packet Header
0x3	GETPD – Get Packet Data
0x4	GETPHD – Get Packet Header and Data
0x5	CLRRXP – Clear Received Packet
0x6	CLROB – Clear Outbound Buffer
0x20 0xAA 0xBB	NVRESET – Reset non-volatile registers to factory default

Figure 84: HumPRO™ Series Command Register Values

The **Send Packet** command starts data transmission. Operation differs depending on whether option TXPKT is set in the PKTOPT register.

- TXPKT = 0; this command operates the same as a data timeout with DATATO. All waiting data, up to the maximum allowed in the remaining channel time, is transmitted.
- TXPKT = 1; this command marks the end of an explicit packet in the outgoing buffer. All bytes within the packet are transmitted together. Following bytes are transmitted in a following packet. The maximum packet length is 192 bytes. Multiple packets can be queued with this command.

The **Get Packet Header** command returns the received packet header using a received packet transfer cycle (see the Receiving Packets section). The header is discarded after transfer. This command is normally issued after receiving a New Packet exception. The packet data can be read

after completion of the header transfer. If the data is not read before this command is issued a second time, then the data is discarded and the header for the following packet is returned. A NAK response is returned if option RXPKT is disabled in the PKTOPT register or the previous GETPx command was not completed.

The **Get Packet Data** command returns the received packet data using a received packet transfer cycle. If the packet header is not read first, then it is discarded. A NAK response is returned if option RXPKT is disabled in the PKTOPT register or the previous GETPx command was not completed.

The **Get Packet Header and Data** command returns the received packet header, followed by the packet data using a received packet transfer cycle. The packet is discarded after transfer. A NAK response is returned if option RXPKT is disabled in the PKTOPT register or the previous GETPx command was not completed.

The **Clear Received Packet** command removes the next unread packet from the RF incoming queue if RXPKT is enabled in the PKTOPT register.

If the packet header was read but not the data, this command causes the data to be discarded. Although not required before reading the next packet's header, it frees buffer space for more or longer messages.

If a previous GETPx command did not deliver all the associated data, this command removes the undelivered data and terminates the previous GETPx command.

If option RXPKT is disabled this command discards all received data which has not been delivered.

The **Clear Outbound Buffer** command cancels any transmission in progress and clears the buffer of data to be transmitted.

The **Non-volatile Reset** command (FF 07 FE 47 20 FE 2A FE 3B) sets all non-volatile registers to their default values. When the configuration is reset, the following message, shown in quotes, is sent out the UART:

```
"\r\nConfiguration Reset\r\n"
```

This reset can also be done by toggling the PB line as described in the Restore Factory Defaults section.

EEXFLAG - Extended Exception Flags

Volatile Address = 0xCD - 0xCF

These volatile registers contain flags for various events. Similar to the EXCEPT register, they provide a separate bit for each exception.

HumPRO™ Series Extended Exception Flags Registers		
Name	Volatile Address	Description
EEXMASK2	0xCD	Byte 2 of the extended exception flags
EEXMASK1	0xCE	Byte 1 of the extended exception flags
EEXMASK0	0xCF	LSB of the extended exception flags

Figure 85: HumPRO™ Series Transceiver Extended Exception Code Registers

When an exception occurs, the associated bit is set in this register. If the corresponding bit in the EEXMASK is set and EXMASK is zero, the EX status line is set. Reading an EEXFLAG register does not clear the register.

Writing to an EEXFLAG register causes the register to be set to the BIT_AND(current_value, new_value). This provides a way of clearing bits that have been serviced without clearing a bit that has been set since the flag register was read. This prevents a loss of notification of an exception.

Register bits can only be cleared, not set, from the write command though some flags are also cleared internally.

Flag EX_TXDONE is set when a data packet has been transmitted. If the packet was sent with acknowledgement enabled, this flag indicates that the acknowledgment has also been received. It is cleared by writing a zero bit to EX_TXDONE in the register.

Flag EX_RXWAIT is 1 when there are buffered incoming data bytes which have not been sent to the UART. It is cleared by reading or discarding all data bytes.

HumPRO™ Series Transceiver Extended Exception Codes		
Bit	Exception Name	Description
EEXFLAG0 (0xCF)		
0	EX_BUFOVFL	Internal UART buffer overflowed.
1	EX_RFOVFL	Internal RF packet buffer overflowed.
2	EX_WRITEREGFAILED	Attempted write to register failed.
3	EX_NOACK	Acknowledgement packet not received after maximum number of retries.
4	EX_BADCRC	Bad CRC detected on incoming packet.
5	EX_BADHEADER	Bad CRC detected in packet header.
6	EX_BADSEQID	Sequence ID was incorrect in ACK packet.
7	EX_BADFRAMETYPE	Unsupported frame type specified.
EEXFLAG1 (0xCE)		
0	EX_TXDONE	A data packet has been transmitted.
1	EX_RXWAIT	Received data bytes are waiting to be read.
2 - 7	Reserved	
EEXFLAG2 (0xCD)		
0 - 7	Reserved	

Figure 86: HumPRO™ Series Transceiver Extended Exception Codes

PKTOPT - Packet Options

Volatile Address = 0xD3; Non-Volatile Address = 0x83

This register selects options for transferring packet data.

HumPRO™ Series Packet Options						
Read Command				Read Response		
Header	Size	Escape	Address	ACK	Address	Value
0xFF	0x02	0xFE	0xD3 0x83	0x06	0xD3 0x83	V1
Write Command						
Header	Size	Address	Value			
0xFF	0x02	0xD3 0x83	V1			

Figure 87: HumPRO™ Series Transceiver Packet Options Command and Response

Each bit in the register sets an option as shown in Figure 88.

HumPRO™ Series Transceiver Extended Exception Codes		
Bit	Name	Description
0	TXPKT	Packet Transmit
1	TXnCMD	Transmit when nCMD Lowered
2	RXPKT	Packet Receive
3	RXP_CTS	Use CTS for RXPKT Transfer
4 - 7	Reserved	Reserved

Figure 88: HumPRO™ Series Transceiver Extended Exception Codes

The TXPKT option allows the module to transmit data in explicit packets.

- TXPKT = 0 (default); a packet transmission is enabled when the number of waiting bytes reaches BCTRIG bytes, the time since the last received byte exceeds DATATO ms, the number of waiting bytes exceeds the number that can be sent within the remaining slot time, or a Send Packet command is written to the CMD register.
- TXPKT = 1; all bytes written to the module are held until a SENDP command is written to the CMD register or the CMD line is lowered with TXnCMD = 1. The DATATO or BCTRIG conditions are ignored with this option. The transmitted packet consists of the bytes in the buffer at the time a packet is triggered, even if more data bytes are received before the packet can be sent.

Multiple outgoing packets can be buffered. Changing this option clears the incoming buffer, losing untransmitted or unacknowledged data.

When TXnCMD is 1, lowering the $\overline{\text{CMD}}$ line has the same effect as writing the SENDP command to the CMD register, triggering buffered data to be transmitted. Packet grouping is affected by option TXPKT. The minimum low time on the $\overline{\text{CMD}}$ line to terminate the packet is given in the Electrical Specifications.

When RXPKT is 1, incoming packets are held until a GETPH, GETPD, or GETPHD command is written to the CMD register. Transfer uses a Packet Receive transfer. The CMDHOLD setting has no effect.

When RXPKT is 0, incoming UART data is delivered without headers. The data flow is controlled by the CMDHOLD setting.

When RXP_CTS is 1, the $\overline{\text{CTS}}$ line is used for the status line during a Packet Receive transfer and not for controlling data flow into the module. When it is 0, $\overline{\text{CTS}}$ is used for flow control and CRESP is used for the status line.

EEXMASK - Extended Exception Mask

Volatile Address = 0x80-0x82; Non-Volatile Address = 0xD0-0xD2

These registers contain a mask for the events in EEXFLAG, using the same offset and bit number.

HumPRO™ Series Extended Exception Mask Registers			
Name	Volatile Address	Non-Volatile Address	Description
EEXMASK2	0x80	0xD0	Byte 2 of the extended exception mask
EEXMASK1	0x81	0xD1	Byte 1 of the extended exception mask
EEXMASK0	0x82	0xD2	LSB of the extended exception mask

Figure 89: HumPRO™ Series Transceiver Extended Exception Mask Registers

To use this value, register EXMASK must be zero. If EXMASK is non-zero, this register has no effect on the EX line.

When an exception bit is set in EEXFLAG, the corresponding EEXMASK bit is set, and EXMASK is zero, the EX status line is set, otherwise the EX line is reset. Mask bits for unassigned flags should be zero for future compatibility.

Typical Applications

Figure 90 shows a typical circuit using the HumPRO™ Series transceiver.

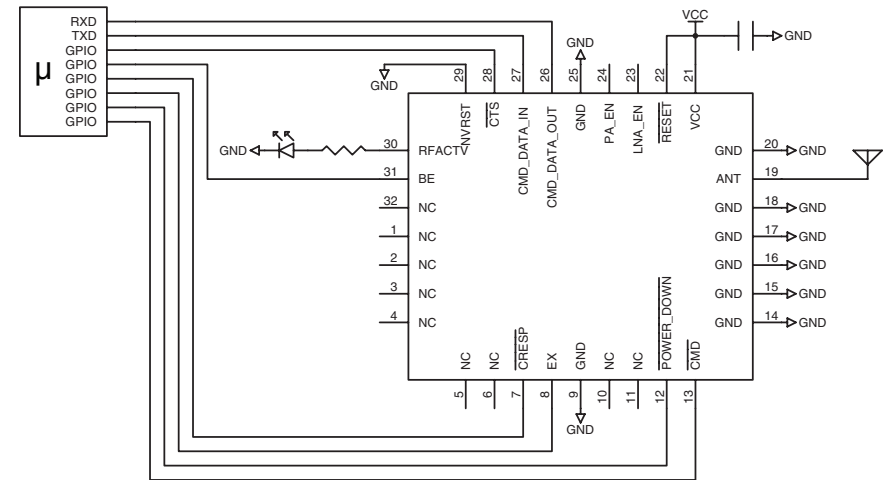

Figure 90: HumPRO™ Series Transceiver Basic Application Circuit

An external microcontroller provides data and configuration commands. Its UART (TXD, RXD) is connected to the module's UART (CMD_DATA_IN, CMD_DATA_OUT). The \overline{CTS} line is monitored for flow control. GPIOs on the microcontroller are connected to lines on the module:

It monitors the \overline{CRESP} line to know when the data coming out of the module is transmitted data or a response to a command.

It monitors the EX line to know if there is an error.

It controls the $\overline{POWER_DOWN}$ line to place the module into a low power state.

It controls the \overline{CMD} line to toggle between configuration commands and data to be transmitted over the air.

The RFACTV line is connected to an LED for visual indication that the module is active.

Usage Guidelines for FCC Compliance

The pre-certified version of the HumPRO™ Series module is provided with an FCC and Industry Canada Modular Certification. This certification shows that the module meets the requirements of FCC Part 15 and Industry Canada license-exempt RSS standards for an intentional radiator. The integrator does not need to conduct any further testing under these rules provided that the following guidelines are met:

- An approved antenna must be directly coupled to the module's U.FL connector through an approved coaxial extension cable.
- Alternate antennas can be used, but may require the integrator to perform certification testing.
- The module must not be modified in any way. Coupling of external circuitry must not bypass the provided connectors.
- End product must be externally labeled with "Contains FCC ID: OJM HUM900PROA / IC: 5840A-HUM900PROA".
- The end product's user's manual must contain an FCC statement equivalent to that listed on page 77 of this data guide.
- The antenna used for this transceiver must not be co-located or operating in conjunction with any other antenna or transmitter.
- The integrator must not provide any information to the end-user on how to install or remove the module from the end-product.

Any changes or modifications not expressly approved by Linx Technologies could void the user's authority to operate the equipment.

Additional Testing Requirements

The modules have been tested for compliance as an intentional radiator, but the integrator is required to perform unintentional radiator testing on the final product per FCC sections 15.107 and 15.109 and Industry Canada license-exempt RSS standards. Additional product-specific testing might be required. Please contact the FCC or Industry Canada regarding regulatory requirements for the application. Ultimately it is the integrator's responsibility to show that their product complies with the regulations applicable to their product.

Information to the user

The following information must be included in the product's user manual.

FCC / IC NOTICES

This product contains FCC ID: OJM HUM900PROA / IC: 5840A-HUM900PROA.

This device complies with Part 15 of the FCC rules and Industry Canada license-exempt RSS standards. Operation of this device is subject to the following two conditions:

1. This device may not cause harmful interference, and
2. this device must accept any interference received, including interference that may cause undesired operation.

This equipment has been tested and found to comply with the limits for a Class B digital device, pursuant to Part 15 of the FCC Rules. These limits are designed to provide reasonable protection against harmful interference in a residential installation. This equipment generates, uses and can radiate radio frequency energy and, if not installed and used in accordance with the instructions, may cause harmful interference to radio communications. However, there is no guarantee that interference will not occur in a particular installation. If this equipment does cause harmful interference to radio or television reception, which can be determined by turning the equipment off and on, the user is encouraged to try to correct the interference by one or more of the following measures:

- Reorient or relocate the receiving antenna.
- Increase the separation between the equipment and receiver.
- Connect the equipment into an outlet on a circuit different from that to which the receiver is connected.
- Consult the dealer or an experienced radio/TV technician for help.

Any modifications could void the user's authority to operate the equipment.

Le présent appareil est conforme aux CNR d'Industrie Canada applicables aux appareils radio exempts de licence. L'exploitation est autorisée aux deux conditions suivantes:

1. l'appareil ne doit pas produire de brouillage, et
2. l'utilisateur de l'appareil doit accepter tout brouillage radioélectrique subi, même si le brouillage est susceptible d'en compromettre le fonctionnement.

Product Labeling

The end product must be labeled to meet the FCC and IC product label requirements. It must have the below or similar text:

Contains FCC ID: OJMHUM900PROA / IC: 5840A-HUM900PROA

The label must be permanently affixed to the product and readily visible to the user. “Permanently affixed” means that the label is etched, engraved, stamped, silkscreened, indelibly printed, or otherwise permanently marked on a permanently attached part of the equipment or on a nameplate of metal, plastic, or other material fastened to the equipment by welding, riveting, or a permanent adhesive. The label must be designed to last the expected lifetime of the equipment in the environment in which the equipment may be operated and must not be readily detachable.

FCC RF Exposure Statement

To satisfy RF exposure requirements, this device and its antenna must operate with a separation distance of at least 20cm from all persons and must not be co-located or operating in conjunction with any other antenna or transmitter.

Antenna Selection

Under FCC and Industry Canada regulations, this radio transmitter may only operate using an antenna of a type and maximum (or lesser) gain approved for the transmitter by the FCC and Industry Canada. To reduce potential radio interference to other users, the antenna type and its gain should be so chosen that the equivalent isotropically radiated power (e.i.r.p.) is not more than that necessary for successful communication.

The HUM-900-PRO-UFL and HUM-900-PRO-CAS radio transmitters have been approved by the FCC and Industry Canada to operate with the antenna types listed in Figure 91 with the maximum permissible gain and required antenna impedance for each antenna type indicated. Antenna types not included in this list, having a gain greater than the maximum gain indicated for that type, are strictly prohibited for use with this device.

Conformément à la réglementation d’Industrie Canada, le présent émetteur radio peut fonctionner avec une antenne d’un type et d’un gain maximal (ou inférieur) approuvé pour l’émetteur par Industrie Canada. Dans le but de réduire les risques de brouillage radioélectrique à l’intention des autres utilisateurs, il faut choisir le type d’antenne et son gain de sorte que la puissance isotrope rayonnée équivalente (p.i.r.e.) ne dépasse pas l’intensité

nécessaire à l’établissement d’une communication satisfaisante.

Le présent émetteur radio (HUM-900-PRO-UFL, HUM-900-PRO-CAS) a été approuvé par Industrie Canada pour fonctionner avec les types d’antenne énumérés la Figure 91 et ayant un gain admissible maximal et l’impédance requise pour chaque type d’antenne. Les types d’antenne non inclus dans cette liste, ou dont le gain est supérieur au gain maximal indiqué, sont strictement interdits pour l’exploitation de l’émetteur.

Antennas / Antennes			
Linx Part Number Référence Linx	Type	Gain	Impedance Impédance
Tested Antennas			
ANT-916-CW-QW	¼ Wave Whip	1.84dBi	50Ω
ANT-916-CW-HW	½ Wave Dipole Helical	1.83dBi	50Ω
ANT-916-PW-LP	¼ Wave Whip	2.44dBi	50Ω
ANT-916-SP	¼ Wave Planar	1.35dBi	50Ω
ANT-916-WRT-RPS	½ Wave Dipole Helical	1.83dBi	50Ω
ANT-916-CHP	¼ Wave Ceramic	1.34dBi	50Ω
Antennas of the same type and same or lesser gain			
ANT-916-CW-HD	¼ Wave Whip	-0.26dBi	50Ω
ANT-916-PW-QW	¼ Wave Whip	1.84dBi	50Ω
ANT-916-CW-RCL	¼ Wave Whip	-2.03dBi	50Ω
ANT-916-CW-RH	¼ Wave Whip	-1.31dBi	50Ω
ANT-916-CW-HWR-RPS	½ Wave Dipole Helical	-1.89dBi	50Ω
ANT-916-PML	½ Wave Dipole Helical	-0.38dBi	50Ω
ANT-916-PW-RA	¼ Wave Whip	0dBi	50Ω
ANT-916-USP	¼ Wave Planar	0.3dBi	50Ω
Cable Assemblies / Assemblages de Câbles			
Linx Part Number Référence Linx	Description		
CSI-RSFB-300-UFFR*	RP-SMA Bulkhead to U.FL with 300mm cable		
CSI-RSFE-300-UFFR*	RP-SMA External Mount Bulkhead to U.FL with 300mm cable		
* Also available in 100mm and 200mm cable length			

Figure 91: HumPRO™ Series Transceiver Approved Antennas

Power Supply Requirements

The module does not have an internal voltage regulator, therefore it requires a clean, well-regulated power source. The power supply noise should be less than 20mV. Power supply noise can significantly affect the module's performance, so providing a clean power supply for the module should be a high priority during design.

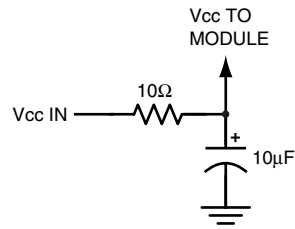

Figure 92: Supply Filter

A 10Ω resistor in series with the supply followed by a 10μF tantalum capacitor from V_{cc} to ground helps in cases where the quality of supply power is poor (Figure 92). This filter should be placed close to the module's supply lines. These values may need to be adjusted depending on the noise present on the supply line.

Antenna Considerations

The choice of antennas is a critical and often overlooked design consideration. The range, performance and legality of an RF link are critically dependent upon the antenna. While adequate antenna performance can often be obtained by trial and error methods, antenna design and matching is a complex task. Professionally designed antennas such as those from Linx (Figure 93) help ensure maximum performance and FCC and other regulatory compliance.



Figure 93: Linx Antennas

Linx transmitter modules typically have an output power that is higher than the legal limits. This allows the designer to use an inefficient antenna such as a loop trace or helical to meet size, cost or cosmetic requirements and still achieve full legal output power for maximum range. If an efficient antenna is used, then some attenuation of the output power will likely be needed.

It is usually best to utilize a basic quarter-wave whip until your prototype product is operating satisfactorily. Other antennas can then be evaluated based on the cost, size and cosmetic requirements of the product. Additional details are in Application Note AN-00500.

Interference Considerations

The RF spectrum is crowded and the potential for conflict with unwanted sources of RF is very real. While all RF products are at risk from interference, its effects can be minimized by better understanding its characteristics.

Interference may come from internal or external sources. The first step is to eliminate interference from noise sources on the board. This means paying careful attention to layout, grounding, filtering and bypassing in order to eliminate all radiated and conducted interference paths. For many products, this is straightforward; however, products containing components such as switching power supplies, motors, crystals and other potential sources of noise must be approached with care. Comparing your own design with a Linx evaluation board can help to determine if and at what level design-specific interference is present.

External interference can manifest itself in a variety of ways. Low-level interference produces noise and hashing on the output and reduces the link's overall range.

High-level interference is caused by nearby products sharing the same frequency or from near-band high-power devices. It can even come from your own products if more than one transmitter is active in the same area. It is important to remember that only one transmitter at a time can occupy a frequency, regardless of the coding of the transmitted signal. This type of interference is less common than those mentioned previously, but in severe cases it can prevent all useful function of the affected device.

Although technically not interference, multipath is also a factor to be understood. Multipath is a term used to refer to the signal cancellation effects that occur when RF waves arrive at the receiver in different phase relationships. This effect is a particularly significant factor in interior environments where objects provide many different signal reflection paths. Multipath cancellation results in lowered signal levels at the receiver and shorter useful distances for the link.

Pad Layout

The pad layout diagrams below are designed to facilitate both hand and automated assembly. Figure 94 shows the footprint for the smaller version and Figure 95 shows the footprint for the pre-certified version.

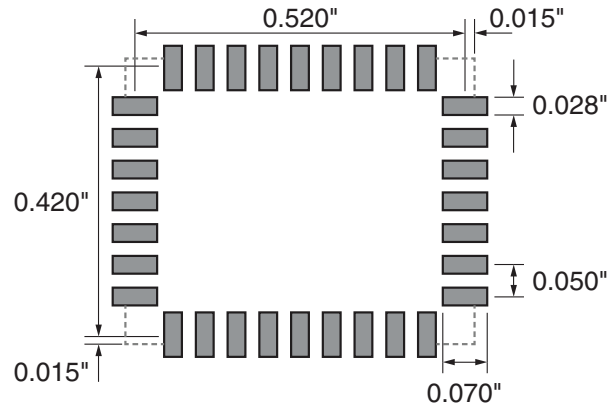

Figure 94: HUM-***-PRO Recommended PCB Layout

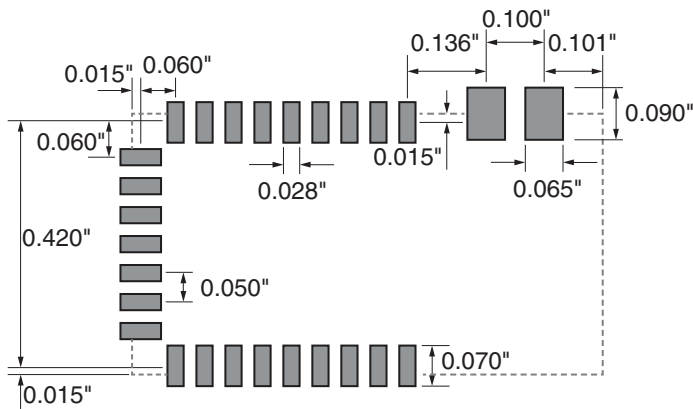

Figure 95: HUM-***-PRO-UFL/CAS Recommended PCB Layout

Microstrip Details

A transmission line is a medium whereby RF energy is transferred from one place to another with minimal loss. This is a critical factor, especially in high-frequency products like Linx RF modules, because the trace leading to the module's antenna can effectively contribute to the length of the antenna, changing its resonant bandwidth. In order to minimize loss and detuning, some form of transmission line between the antenna and the module should be used unless the antenna can be placed very close (<1/8in) to the module. One common form of transmission line is a coax cable and another is the microstrip. This term refers to a PCB trace running over a ground plane that is designed to serve as a transmission line between the module and the antenna. The width is based on the desired characteristic impedance of the line, the thickness of the PCB and the dielectric constant of the board material. For standard 0.062in thick FR-4 board material, the trace width would be 111 mils. The correct trace width can be calculated for other widths and materials using the information in Figure 96 and examples are provided in Figure 97. Software for calculating microstrip lines is also available on the Linx website.

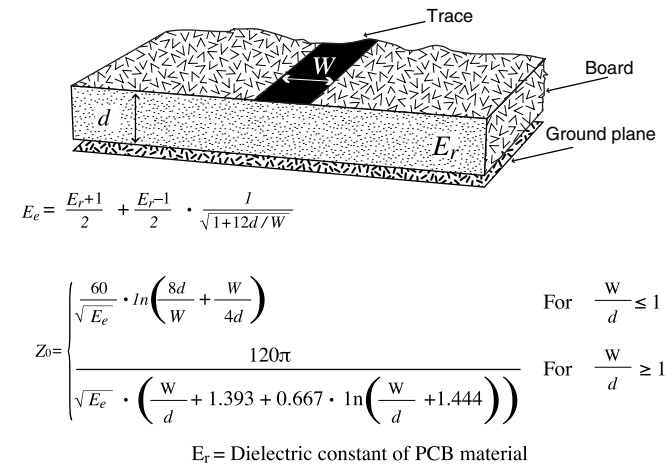

Figure 96: Microstrip Formulas

Example Microstrip Calculations

Dielectric Constant	Width / Height Ratio (W / d)	Effective Dielectric Constant	Characteristic Impedance (Ω)
4.80	1.8	3.59	50.0
4.00	2.0	3.07	51.0
2.55	3.0	2.12	48.8

Figure 97: Example Microstrip Calculations

Board Layout Guidelines

The module's design makes integration straightforward; however, it is still critical to exercise care in PCB layout. Failure to observe good layout techniques can result in a significant degradation of the module's performance. A primary layout goal is to maintain a characteristic 50-ohm impedance throughout the path from the antenna to the module. Grounding, filtering, decoupling, routing and PCB stack-up are also important considerations for any RF design. The following section provides some basic design guidelines.

During prototyping, the module should be soldered to a properly laid-out circuit board. The use of prototyping or "perf" boards results in poor performance and is strongly discouraged. Likewise, the use of sockets can have a negative impact on the performance of the module and is discouraged.

The module should, as much as reasonably possible, be isolated from other components on your PCB, especially high-frequency circuitry such as crystal oscillators, switching power supplies, and high-speed bus lines.

When possible, separate RF and digital circuits into different PCB regions.

Make sure internal wiring is routed away from the module and antenna and is secured to prevent displacement.

Do not route PCB traces directly under the module. There should not be any copper or traces under the module on the same layer as the module, just bare PCB. The underside of the module has traces and vias that could short or couple to traces on the product's circuit board.

The Pad Layout section shows a typical PCB footprint for the module. A ground plane (as large and uninterrupted as possible) should be placed on a lower layer of your PC board opposite the module. This plane is essential for creating a low impedance return for ground and consistent stripline performance.

Use care in routing the RF trace between the module and the antenna or connector. Keep the trace as short as possible. Do not pass it under the module or any other component. Do not route the antenna trace on multiple PCB layers as vias add inductance. Vias are acceptable for tying together ground layers and component grounds and should be used in multiples.

Each of the module's ground pins should have short traces tying immediately to the ground plane through a via.

Bypass caps should be low ESR ceramic types and located directly adjacent to the pin they are serving.

A 50-ohm coax should be used for connection to an external antenna. A 50-ohm transmission line, such as a microstrip, stripline or coplanar waveguide should be used for routing RF on the PCB. The Microstrip Details section provides additional information.

In some instances, a designer may wish to encapsulate or "pot" the product. There are a wide variety of potting compounds with varying dielectric properties. Since such compounds can considerably impact RF performance and the ability to rework or service the product, it is the responsibility of the designer to evaluate and qualify the impact and suitability of such materials.

Helpful Application Notes from Linx

It is not the intention of this manual to address in depth many of the issues that should be considered to ensure that the modules function correctly and deliver the maximum possible performance. We recommend reading the application notes listed in Figure 98 which address in depth key areas of RF design and application of Linx products. These applications notes are available online at www.linxtechnologies.com or by contacting the Linx literature department.

Helpful Application Note Titles	
Note Number	Note Title
AN-00100	RF 101: Information for the RF Challenged
AN-00126	Considerations for Operation Within the 902–928MHz Band
AN-00130	Modulation Techniques for Low-Cost RF Data Links
AN-00140	The FCC Road: Part 15 from Concept to Approval
AN-00500	Antennas: Design, Application, Performance
AN-00501	Understanding Antenna Specifications and Operation

Figure 98: Helpful Application Note Titles

Production Guidelines

The module is housed in a hybrid SMD package that supports hand and automated assembly techniques. Since the modules contain discrete components internally, the assembly procedures are critical to ensuring the reliable function of the modules. The following procedures should be reviewed with and practiced by all assembly personnel.

Hand Assembly

Pads located on the bottom of the module are the primary mounting surface (Figure 99). Since these pads are inaccessible during mounting, castellations that run up the side of the module have been provided to facilitate solder wicking to the module's underside. This allows for very

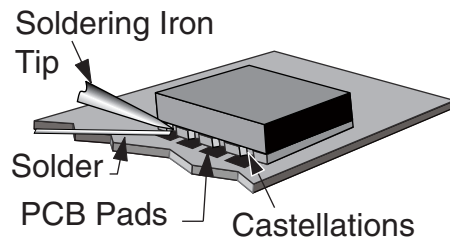

Figure 99: Soldering Technique

quick hand soldering for prototyping and small volume production. If the recommended pad guidelines have been followed, the pads will protrude slightly past the edge of the module. Use a fine soldering tip to heat the board pad and the castellation, then introduce solder to the pad at the module's edge. The solder will wick underneath the module, providing reliable attachment. Tack one module corner first and then work around the device, taking care not to exceed the times in Figure 100.

Warning: Pay attention to the absolute maximum solder times.

Absolute Maximum Solder Times

Hand Solder Temperature: +427°C for 10 seconds for lead-free alloys

Reflow Oven: +255°C max (see Figure 101)

Figure 100: Absolute Maximum Solder Times

Automated Assembly

For high-volume assembly, the modules are generally auto-placed. The modules have been designed to maintain compatibility with reflow processing techniques; however, due to their hybrid nature, certain aspects of the assembly process are far more critical than for other component types. Following are brief discussions of the three primary areas where caution must be observed.

Reflow Temperature Profile

The single most critical stage in the automated assembly process is the reflow stage. The reflow profile in Figure 101 should not be exceeded because excessive temperatures or transport times during reflow will irreparably damage the modules. Assembly personnel need to pay careful attention to the oven's profile to ensure that it meets the requirements necessary to successfully reflow all components while still remaining within the limits mandated by the modules. The figure below shows the recommended reflow oven profile for the modules.

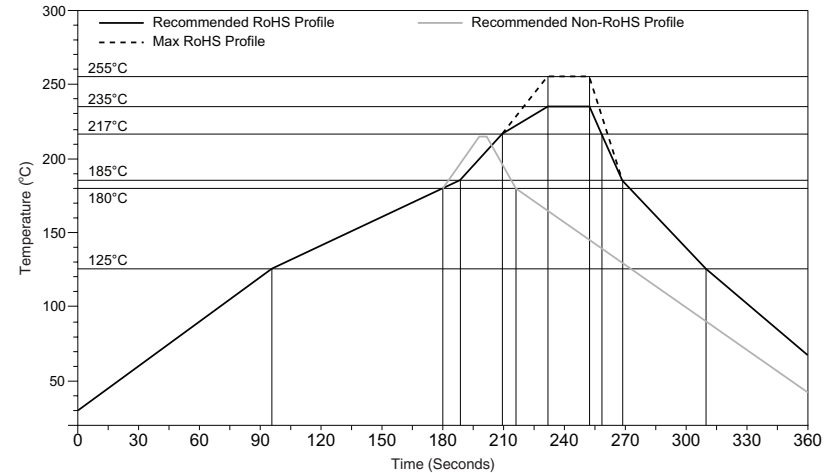

Figure 101: Maximum Reflow Temperature Profile

Shock During Reflow Transport

Since some internal module components may reflow along with the components placed on the board being assembled, it is imperative that the modules not be subjected to shock or vibration during the time solder is liquid. Should a shock be applied, some internal components could be lifted from their pads, causing the module to not function properly.

Washability

The modules are wash-resistant, but are not hermetically sealed. Linx recommends wash-free manufacturing; however, the modules can be subjected to a wash cycle provided that a drying time is allowed prior to applying electrical power to the modules. The drying time should be sufficient to allow any moisture that may have migrated into the module to evaporate, thus eliminating the potential for shorting damage during power-up or testing. If the wash contains contaminants, the performance may be adversely affected, even after drying.

General Antenna Rules

The following general rules should help in maximizing antenna performance.

1. Proximity to objects such as a user's hand, body or metal objects will cause an antenna to detune. For this reason, the antenna shaft and tip should be positioned as far away from such objects as possible.
2. Optimum performance is obtained from a $\frac{1}{4}$ - or $\frac{1}{2}$ -wave straight whip mounted at a right angle to the ground plane (Figure 102). In many cases, this isn't desirable for practical or ergonomic reasons, thus, an alternative antenna style such as a helical, loop or patch may be utilized and the corresponding sacrifice in performance accepted.

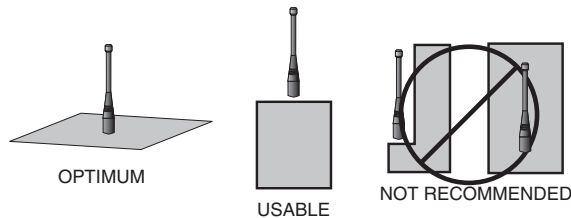

Figure 102: Ground Plane Orientation

3. If an internal antenna is to be used, keep it away from other metal components, particularly large items like transformers, batteries, PCB tracks and ground planes. In many cases, the space around the antenna is as important as the antenna itself. Objects in close proximity to the antenna can cause direct detuning, while those farther away will alter the antenna's symmetry.
4. In many antenna designs, particularly $\frac{1}{4}$ -wave whips, the ground plane acts as a counterpoise, forming, in essence, a $\frac{1}{2}$ -wave dipole (Figure 103). For this reason, adequate ground plane area is essential. The ground plane can be a metal case or ground-fill areas on a circuit board. Ideally, it should have a surface area less than or equal to the overall length of the $\frac{1}{4}$ -wave radiating element. This is often not practical due to size and configuration constraints. In these instances, a designer must make the best use of the area available to create as much ground

VERTICAL $\lambda/4$ GROUNDED ANTENNA (MARCONI)

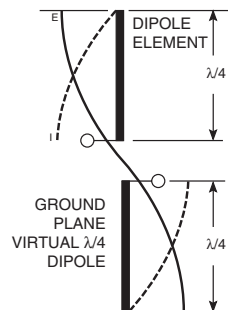

Figure 103: Dipole Antenna

plane as possible in proximity to the base of the antenna. In cases where the antenna is remotely located or the antenna is not in close proximity to a circuit board, ground plane or grounded metal case, a metal plate may be used to maximize the antenna's performance.

5. Remove the antenna as far as possible from potential interference sources. Any frequency of sufficient amplitude to enter the receiver's front end will reduce system range and can even prevent reception entirely. Switching power supplies, oscillators or even relays can also be significant sources of potential interference. The single best weapon against such problems is attention to placement and layout. Filter the module's power supply with a high-frequency bypass capacitor. Place adequate ground plane under potential sources of noise to shunt noise to ground and prevent it from coupling to the RF stage. Shield noisy board areas whenever practical.
6. In some applications, it is advantageous to place the module and antenna away from the main equipment (Figure 104). This can avoid interference problems and allows the antenna to be oriented for optimum performance. Always use 50Ω coax, like RG-174, for the remote feed.

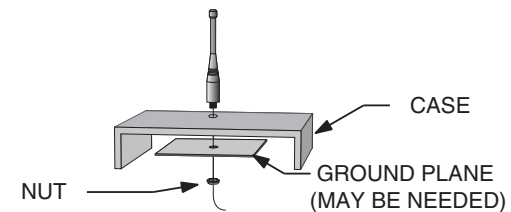

Figure 104: Remote Ground Plane

Common Antenna Styles

There are hundreds of antenna styles and variations that can be employed with Linx RF modules. Following is a brief discussion of the styles most commonly utilized. Additional antenna information can be found in Linx Application Notes AN-00100, AN-00140, AN-00500 and AN-00501. Linx antennas and connectors offer outstanding performance at a low price.

Whip Style

A whip style antenna (Figure 105) provides outstanding overall performance and stability. A low-cost whip can be easily fabricated from a wire or rod, but most designers opt for the consistent performance and cosmetic appeal of a professionally-made model. To meet this need, Linx offers a wide variety of straight and reduced height whip style antennas in permanent and connectorized mounting styles.



Figure 105: Whip Style Antennas

The wavelength of the operational frequency determines an antenna's overall length. Since a full wavelength is often quite long, a partial 1/2- or 1/4-wave antenna is normally employed. Its size and natural radiation resistance make it well matched to Linx modules. The proper length for a straight 1/4-wave can be easily determined using the formula in Figure 106. It is also possible to reduce the overall height of the antenna by using a helical winding. This reduces the antenna's bandwidth but is a great way to minimize the antenna's physical size for compact applications. This also means that the physical appearance is not always an indicator of the antenna's frequency.

$$L = \frac{234}{F_{\text{MHz}}}$$

Figure 106:
L = length in feet of quarter-wave length
F = operating frequency in megahertz

Specialty Styles

Linx offers a wide variety of specialized antenna styles (Figure 107). Many of these styles utilize helical elements to reduce the overall antenna size while maintaining reasonable performance. A helical antenna's bandwidth is often quite narrow and the antenna can detune in proximity to other objects, so care must be exercised in layout and placement.



Figure 107: Specialty Style Antennas

Loop Style

A loop or trace style antenna is normally printed directly on a product's PCB (Figure 108). This makes it the most cost-effective of antenna styles. The element can be made self-resonant or externally resonated with discrete components, but its actual layout is usually product specific. Despite the cost advantages, loop style antennas are generally inefficient and useful only for short range applications. They are also very sensitive to changes in layout and PCB dielectric, which can cause consistency issues during production. In addition, printed styles are difficult to engineer, requiring the use of expensive equipment including a network analyzer. An improperly designed loop will have a high VSWR at the desired frequency which can cause instability in the RF stage.



Figure 108: Loop or Trace Antenna

Linx offers low-cost planar (Figure 109) and chip antennas that mount directly to a product's PCB. These tiny antennas do not require testing and provide excellent performance despite their small size. They offer a preferable alternative to the often problematic "printed" antenna.



Figure 109: SP Series "Splatch" and uSP "MicroSplatch" Antennas

Regulatory Considerations

Note: Linx RF modules are designed as component devices that require external components to function. The purchaser understands that additional approvals may be required prior to the sale or operation of the device, and agrees to utilize the component in keeping with all laws governing its use in the country of operation.

When working with RF, a clear distinction must be made between what is technically possible and what is legally acceptable in the country where operation is intended. Many manufacturers have avoided incorporating RF into their products as a result of uncertainty and even fear of the approval and certification process. Here at Linx, our desire is not only to expedite the design process, but also to assist you in achieving a clear idea of what is involved in obtaining the necessary approvals to legally market a completed product.

For information about regulatory approval, read AN-00142 on the Linx website or call Linx. Linx designs products with worldwide regulatory approval in mind.

In the United States, the approval process is actually quite straightforward. The regulations governing RF devices and the enforcement of them are the responsibility of the Federal Communications Commission (FCC). The regulations are contained in Title 47 of the United States Code of Federal Regulations (CFR). Title 47 is made up of numerous volumes; however, all regulations applicable to this module are contained in Volume 0-19. It is strongly recommended that a copy be obtained from the FCC's website, the Government Printing Office in Washington or from your local government bookstore. Excerpts of applicable sections are included with Linx evaluation kits or may be obtained from the Linx Technologies website, www.linxtechnologies.com. In brief, these rules require that any device that intentionally radiates RF energy be approved, that is, tested for compliance and issued a unique identification number. This is a relatively painless process. Final compliance testing is performed by one of the many independent testing laboratories across the country. Many labs can also provide other certifications that the product may require at the same time, such as UL, CLASS A / B, etc. Once the completed product has passed, an ID number is issued that is to be clearly placed on each product manufactured.

Questions regarding interpretations of the Part 2 and Part 15 rules or the measurement procedures used to test intentional radiators such as Linx RF modules for compliance with the technical standards of Part 15 should be addressed to:

Federal Communications Commission
Equipment Authorization Division
Customer Service Branch, MS 1300F2
7435 Oakland Mills Road
Columbia, MD, US 21046
Phone: + 1 301 725 585 | Fax: + 1 301 344 2050
Email: labinfo@fcc.gov

ETSI Secretaria
650, Route des Lucioles
06921 Sophia-Antipolis Cedex
FRANCE
Phone: +33 (0)4 92 94 42 00
Fax: +33 (0)4 93 65 47 16

International approvals are slightly more complex, although Linx modules are designed to allow all international standards to be met. If the end product is to be exported to other countries, contact Linx to determine the specific suitability of the module to the application.

All Linx modules are designed with the approval process in mind and thus much of the frustration that is typically experienced with a discrete design is eliminated. Approval is still dependent on many factors, such as the choice of antennas, correct use of the frequency selected and physical packaging. While some extra cost and design effort are required to address these issues, the additional usefulness and profitability added to a product by RF makes the effort more than worthwhile.

Notes



Linx Technologies
159 Ort Lane
Merlin, OR, US 97532

Phone: +1 541 471 6256
Fax: +1 541 471 6251

www.linxtechnologies.com

Disclaimer

Linx Technologies is continually striving to improve the quality and function of its products. For this reason, we reserve the right to make changes to our products without notice. The information contained in this Data Guide is believed to be accurate as of the time of publication. Specifications are based on representative lot samples. Values may vary from lot-to-lot and are not guaranteed. "Typical" parameters can and do vary over lots and application. Linx Technologies makes no guarantee, warranty, or representation regarding the suitability of any product for use in any specific application. It is the customer's responsibility to verify the suitability of the part for the intended application. **NO LINX PRODUCT IS INTENDED FOR USE IN ANY APPLICATION WHERE THE SAFETY OF LIFE OR PROPERTY IS AT RISK.**

Linx Technologies **DISCLAIMS ALL WARRANTIES OF MERCHANTABILITY AND FITNESS FOR A PARTICULAR PURPOSE. IN NO EVENT SHALL LINX TECHNOLOGIES BE LIABLE FOR ANY OF CUSTOMER'S INCIDENTAL OR CONSEQUENTIAL DAMAGES ARISING IN ANY WAY FROM ANY DEFECTIVE OR NON-CONFORMING PRODUCTS OR FOR ANY OTHER BREACH OF CONTRACT BY LINX TECHNOLOGIES.** The limitations on Linx Technologies' liability are applicable to any and all claims or theories of recovery asserted by Customer, including, without limitation, breach of contract, breach of warranty, strict liability, or negligence. Customer assumes all liability (including, without limitation, liability for injury to person or property, economic loss, or business interruption) for all claims, including claims from third parties, arising from the use of the Products. The Customer will indemnify, defend, protect, and hold harmless Linx Technologies and its officers, employees, subsidiaries, affiliates, distributors, and representatives from and against all claims, damages, actions, suits, proceedings, demands, assessments, adjustments, costs, and expenses incurred by Linx Technologies as a result of or arising from any Products sold by Linx Technologies to Customer. Under no conditions will Linx Technologies be responsible for losses arising from the use or failure of the device in any application, other than the repair, replacement, or refund limited to the original product purchase price. Devices described in this publication may contain proprietary, patented, or copyrighted techniques, components, or materials. Under no circumstances shall any user be conveyed any license or right to the use or ownership of such items.

©2014 Linx Technologies. All rights reserved.

The stylized Linx logo, Wireless Made Simple, WISE, CipherLinx and the stylized CL logo are trademarks of Linx Technologies.

Компания «Life Electronics» занимается поставками электронных компонентов импортного и отечественного производства от производителей и со складов крупных дистрибьюторов Европы, Америки и Азии.

С конца 2013 года компания активно расширяет линейку поставок компонентов по направлению коаксиальный кабель, кварцевые генераторы и конденсаторы (керамические, пленочные, электролитические), за счёт заключения дистрибьюторских договоров

Мы предлагаем:

- Конкурентоспособные цены и скидки постоянным клиентам.
- Специальные условия для постоянных клиентов.
- Подбор аналогов.
- Поставку компонентов в любых объемах, удовлетворяющих вашим потребностям.
- Приемлемые сроки поставки, возможна ускоренная поставка.
- Доставку товара в любую точку России и стран СНГ.
- Комплексную поставку.
- Работу по проектам и поставку образцов.
- Формирование склада под заказчика.
- Сертификаты соответствия на поставляемую продукцию (по желанию клиента).
- Тестирование поставляемой продукции.
- Поставку компонентов, требующих военную и космическую приемку.
- Входной контроль качества.
- Наличие сертификата ISO.

В составе нашей компании организован Конструкторский отдел, призванный помогать разработчикам, и инженерам.

Конструкторский отдел помогает осуществить:

- Регистрацию проекта у производителя компонентов.
- Техническую поддержку проекта.
- Защиту от снятия компонента с производства.
- Оценку стоимости проекта по компонентам.
- Изготовление тестовой платы монтаж и пусконаладочные работы.



Тел: +7 (812) 336 43 04 (многоканальный)

Email: org@lifeelectronics.ru