



□ IP67 [E] CE CB

### ■ Features

- Constant current design
- Universal AC input/full range
- Withstand 300VAC surge input for 5 seconds
- High efficiency up to 90%
- Protections: Short circuit / Over voltage
- Cooling by free air convection
- Fully encapsulated with IP67 level (Note.6)
- Fully isolated plastic case
- Class II power unit, no FG
- 100% full load burn-in test
- Low cost, high reliability
- 2 years warranty (Note.4)

### ■ Applications

- Suitable for LED related fixture or appliance (such as LED Decoration or Advertisement devices)

### ■ Description

LPC-100 series is one 100W single output AC/DC LED switching power supply. It features the constant current design, providing various models with the output current ranging from 350mA through 2100mA the LED lighting applications employ the most frequently.

LPC-100 operates for the range 90~264VAC so it can perfectly work for most of the countries in the world. The whole series is based on class II (without FG pin) design, housed with a 94V-0 flame retardant plastic case. With the working efficiency up to 90%, LPC-100 can work at the ambient temperature between -25°C~+50°C under air convection.

### ■ Model Encoding

LPC - 100 - 700

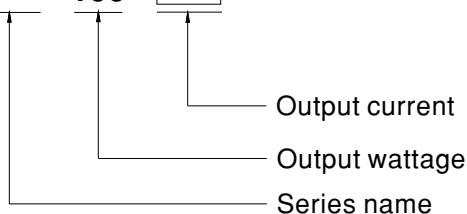



**SPECIFICATION**

MODEL		LPC-100-350	LPC-100-500	LPC-100-700	LPC-100-1050	LPC-100-1400	LPC-100-1750	LPC-100-2100	
OUTPUT	RATED CURRENT	350mA	500mA	700mA	1050mA	1400mA	1750mA	2100mA	
	CURRENT ACCURACY	±5.0%							
	CONSTANT CURRENT REGION <small>Note.5</small>	143 ~ 286V	100 ~ 200V	72 ~ 143V	48 ~ 96V	36 ~ 72V	29 ~ 58V	24 ~ 48V	
	RATED POWER	100.1W	100W	100.1W	100.8W	100.8W	101.5W	100.8W	
	RIPPLE CURRENT	±5%							
	RIPPLE & NOISE	1.5Vp-p	1.5Vp-p	1Vp-p	1Vp-p	1Vp-p	1Vp-p	1Vp-p	
	LINE REGULATION	±1%							
	VOLTAGE TOLERANCE	±1.5%							
	SETUP, RISE TIME	1000ms, 80ms / 230VAC    2000ms,80ms/115VAC at full load							
HOLD UP TIME (Typ.)	16ms/230VAC    10ms/115vac at full load								
INPUT	VOLTAGE RANGE <small>Note.2</small>	90 ~ 264VAC	127VDC ~ 370VDC						
	FREQUENCY RANGE	47 ~ 63Hz							
	EFFICIENCY (Typ.)	90%					89.5%		89%
	AC CURRENT (Typ.)	2.2A / 115VAC		1.2A / 230VAC					
	INRUSH CURRENT (Typ.)	COLD START 75A(twidth=980µs measured at 50% Ipeak) at 230VAC							
	MAX. No. of PSUs on 16A CIRCUIT BREAKER	1 units (circuit breaker of type B) / 2 units (circuit breaker of type C) at 230VAC							
	LEAKAGE CURRENT	<0.25mA / 240VAC							
PROTECTION	SHORT CIRCUIT	Hiccup mode, recovers automatically after fault condition is removed							
	OVER VOLTAGE	315 ~ 345V	220 ~ 240V	160 ~ 172V	108 ~ 120V	80 ~ 97V	65 ~ 80V	58 ~ 68V	
		Protection type : Shut down and latch off o/p voltage re-power on to recovery							
ENVIRONMENT	WORKING TEMP.	-25 ~ +50°C (Refer to "Derating Curve")							
	WORKING HUMIDITY	10 ~ 95% RH non-condensing							
	STORAGE TEMP., HUMIDITY	-40 ~ +80°C, 10 ~ 95% RH							
	TEMP. COEFFICIENT	±0.03%/°C (0 ~ 50°C)							
	VIBRATION	10 ~ 500Hz, 2G 10min./1cycle, period for 60min. each along X, Y, Z axes							
SAFETY & EMC	SAFETY STANDARDS	IEC/EN 62368-1;EAC TP TC 004, IP67 approved,							
	WITHSTAND VOLTAGE	I/P-O/P:3KVAC							
	ISOLATION RESISTANCE	I/P-O/P:100M Ohms / 500VDC / 25°C / 70% RH							
	EMC EMISSION	Compliance to EN55032(CISPR32) Class B; EN61000-3-2 Class A(≦80% load); EN61000-3-3, EAC TP TC 020							
	EMC IMMUNITY	Compliance to EN61000-4-2,3,4,5,6,8,11, EN55024, light industry level , criteria A, EAC TP TC 020							
OTHERS	MTBF	511Khrs min. MIL-HDBK-217F (25°C)							
	DIMENSION	190*52*37mm (L*W*H)							
	PACKING	0.61Kg;20pcs/13.2Kg/0.55CUFT							
NOTE	<p>1. All parameters NOT specially mentioned are measured at 230VAC input, rated load and 25°C of ambient temperature.</p> <p>2. Derating may be needed under low input voltages. Please check the static characteristics for more details.</p> <p>3. The power supply is considered as a component that will be operated in combination with final equipment. Since EMC performance will be affected by the complete installation, the final equipment manufacturers must re-qualify EMC Directive on the complete installation again.</p> <p>4. Refer to warranty statement.</p> <p>5. Constant current operation region is within 50% ~100% rated output voltage. This is the suitable operation region for LED related applications, but please reconfirm special electrical requirements for some specific system design.</p> <p>6. Suitable for indoor use or outdoor use without direct sunlight exposure, please avoid immerse in the water over 30minutes.</p> <p>7. The ambient temperature derating of 3.5°C/1000m with fanless models and of 5°C/1000m with fan models for operating altitude higher than 2000m(6500ft).</p> <p>8. For any application note and IP water proof function installation caution, please refer our user manual before using.  <a href="https://www.meanwell.com/Upload/PDF/LED_EN.pdf">https://www.meanwell.com/Upload/PDF/LED_EN.pdf</a></p> <p>9. This product is not intended for LED applications in the EU.(In the EU NPF/LPF/XLG series are recommended.)</p> <p>10. To fulfill requirements of latest ErP regulation for lighting luminaires, this LED Driver can only be used behind a switch without permanently connected to mains.</p>								

■ Mechanical Specification

Case No. LPC-100 Unit:mm

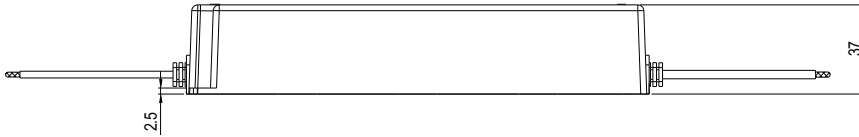
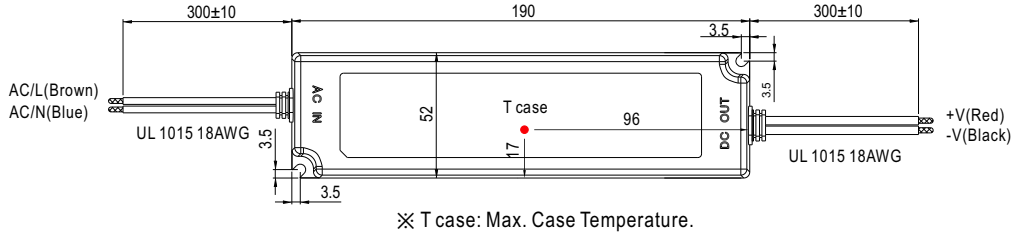

■ Recommend Mounting Direction

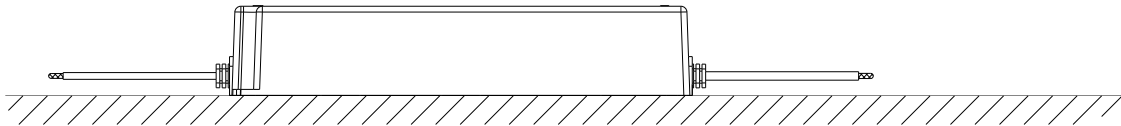

■ Block Diagram

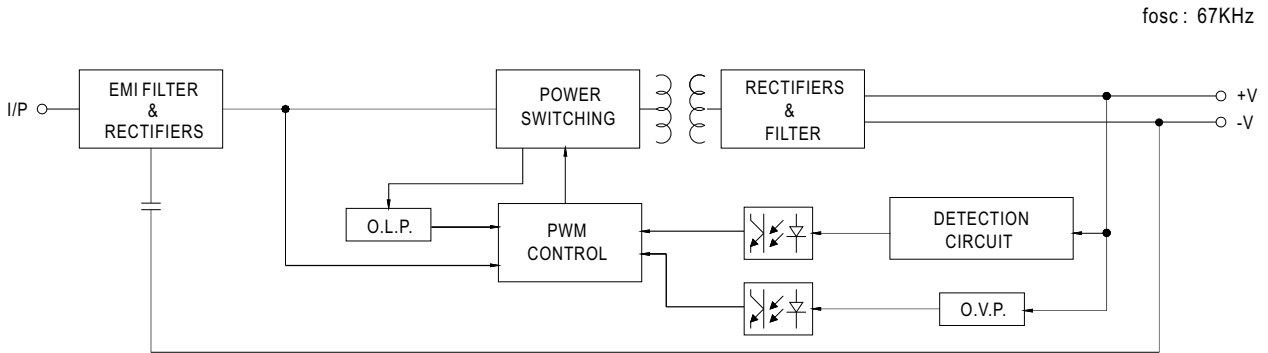

■ Derating Curve

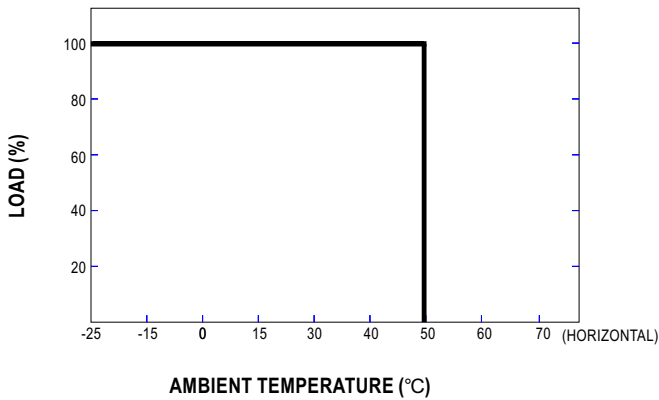

■ Static Characteristics

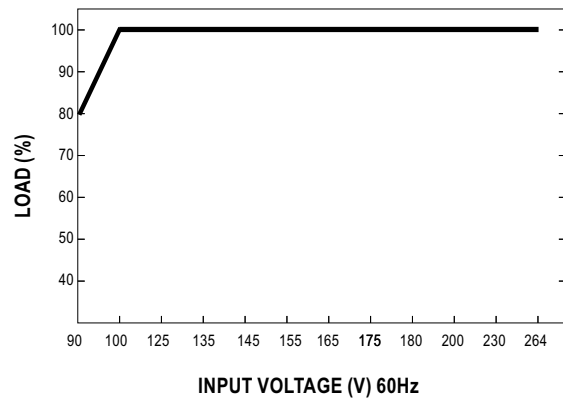

Компания «Life Electronics» занимается поставками электронных компонентов импортного и отечественного производства от производителей и со складов крупных дистрибьюторов Европы, Америки и Азии.

С конца 2013 года компания активно расширяет линейку поставок компонентов по направлению коаксиальный кабель, кварцевые генераторы и конденсаторы (керамические, пленочные, электролитические), за счёт заключения дистрибьюторских договоров

Мы предлагаем:

- Конкурентоспособные цены и скидки постоянным клиентам.
- Специальные условия для постоянных клиентов.
- Подбор аналогов.
- Поставку компонентов в любых объемах, удовлетворяющих вашим потребностям.
- Приемлемые сроки поставки, возможна ускоренная поставка.
- Доставку товара в любую точку России и стран СНГ.
- Комплексную поставку.
- Работу по проектам и поставку образцов.
- Формирование склада под заказчика.
- Сертификаты соответствия на поставляемую продукцию (по желанию клиента).
- Тестирование поставляемой продукции.
- Поставку компонентов, требующих военную и космическую приемку.
- Входной контроль качества.
- Наличие сертификата ISO.

В составе нашей компании организован Конструкторский отдел, призванный помогать разработчикам, и инженерам.

Конструкторский отдел помогает осуществить:

- Регистрацию проекта у производителя компонентов.
- Техническую поддержку проекта.
- Защиту от снятия компонента с производства.
- Оценку стоимости проекта по компонентам.
- Изготовление тестовой платы монтаж и пусконаладочные работы.



Тел: +7 (812) 336 43 04 (многоканальный)

Email: [org@lifeelectronics.ru](mailto:org@lifeelectronics.ru)