

Pushbutton Switch A16

Mounting Aperture of 16 mm

- Modular construction (Pushbutton + Case + Lamp + Switch)
- Wide Variety of Control and Signal Devices: Lighted, Non-Lighted, and Buzzer
- UL and cUL approved.
- Conforms to EN60947-5-1, IEC947-5-1
- Quick and easy assembly, snap-in Switch.
- Wide range of switching capacity from standard to microload
- High reliability, IP65
- Short mounting depth, less than 28.5 mm below panel

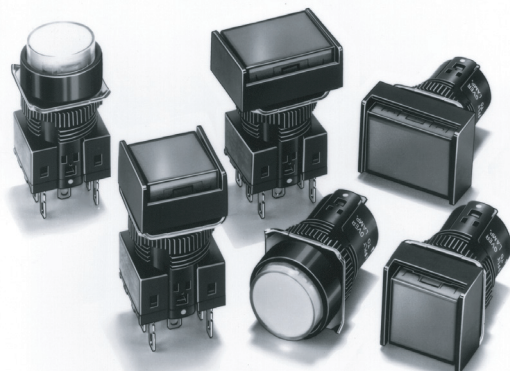

Model Number Structure

Model Number Legend

Completely Assembled

The model numbers used to order sets of Units are illustrated below. One set comprises the Pushbutton, Lamp (lighted models only), Case, and Switch.

A
1
6
5
L
-
J
R
M
-
24
D
-
2

(1) Degree of Protection

Symbol	Protection
No symbol	IP40
5	IP65 oil-resistant

(2) Lighted/Non-lighted

Symbol	Type
No symbol	Non-lighted
L	Lighted

(3) Shape of Pushbutton

Symbol	Shape
J	Rectangular 2-way guard
A	Square 2-way guard
T	Round Projecting model
3J	Rectangular 3-way guard
BA	Square 24-mm square

(4) Color of Pushbutton

Symbol	Color
R	Red
Y	Yellow
PY	Pure yellow
G	Green
W	White
A	Blue
B	Black (non-lighted models only)

"Colored-illumination" models operate in the way shown below:

Unlit	Lit
White	Color

The built-in LED is colored.

(5) Switch Operation

Symbol	Operation
M	Momentary
A	Alternate

Momentary-action: Self-resetting
Alternate-action: Self-holding

(6) Light Source

Symbol	Type	Operating voltage	Rated voltage
No symbol	Non-lighted		
5	Incandescent lamp	5 VAC/VDC	6 VAC/VDC
12		12 VAC/VDC	14 VAC/VDC
24		24 VAC/VDC	28 VAC/VDC
5D	LED	5 ±5% VDC	5 VDC
12D		12 ±5% VDC	12 VDC
24D		24 ±5% VDC	24 VDC

Voltage Reduction Unit (24-V Built-in LED)







Symbol	Type	Operating voltage	Rated voltage
T1	LED	90 to 121 VAC/VDC	110 VAC
T2		180 to 242 VAC/VDC	220 VAC

(7) Contact Configuration

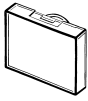
Symbol	Type	Terminal
1	SPDT	Solder Terminal
2	DPDT	Solder Terminal
1P	SPDT	PCB Terminal
2P	DPDT	PCB Terminal
2S	DPDT	Screw-Less Clamp

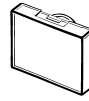
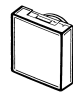
Only DPDT contacts are available with Screw-Less Clamp.

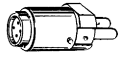
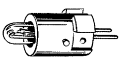
Neon lamps are not available with models that are ordered as a set. They must be ordered individually if required. Refer to page 13.

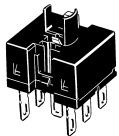
Model	Lighted Pushbutton Switches	Non-lighted Pushbutton Switches
Pushbutton	<p>Rectangular </p> <p>Square </p> <p>Round </p>	<p>Rectangular </p> <p>Square </p> <p>Round </p>
Lamp	<p>LED lamp  Incandescent lamp  Neon lamp </p>	
Case		
Switch	<p>Solder Terminals (Without Voltage Reduction Unit)</p> 	

Note: There is no Lamp with non-lighted models.

Subassembled

1. Pushbutton

Non-lighted/Lighted

A16□L-□□
1 2 3

1. Degree of Protection

None: IP40

5: IP65

2. Flange Shape

J: Rectangular

T: Round

A: Square

3. Illumination Color for Non-lighted Models

R: Red

G: Green

Y: Yellow

W: White

A: Blue

B: Black

Illumination Color for Lighted Models

LED/Incandescent Lamp

R: Red

Y: Yellow

PY: Pure yellow

W: White

A: Blue

LED

GY: Green

Incandescent Lamp

G: Green

Neon Lamp

RN: Red

GN: Green

2. Lamp

A16-□□
1 2

1. Operating Voltage (Rated Voltage)

Incandescent Lamp

- 5: 5 VAC/VDC (6 VAC/VDC)
- 12: 12 VAC/VDC (14 VAC/VDC)
- 24: 24 VAC/VDC (28 VAC/VDC)

LED

- 5DS: 5 VDC (5 VDC)
- 12DS: 12 VDC (12 VDC)
- 24DS: 24 VDC (24 VDC)

Neon Lamp

- 1N: 100 VAC (110 VAC)
- 2N: 200 VAC (220 VAC)

2. Illumination Color

- None: Incandescent Lamp
- R: Red (LED)
- G: Green (LED)
- Y: Yellow (LED)
- W: White (LED)
- A: Blue (LED)
- RN: Red (Neon Lamp)
- GN: Green (Neon Lamp)

3. Case

A16□-□□□
1 2 3

1. Degree of Protection

- None: IP40
- 5: IP65 Oil-resistant

2. Flange Shape

- CJ: Rectangular
- CT: Round
- CA: Square

3. Switch Action

- M: Momentary
- A: Alternate

4. Switch (Solder Terminals)

A16-□-□
1 2

1. Voltage Reduction Circuit

(Operating Voltage/Rated Voltage)

- None: Without Voltage Reduction Unit
- T1: 100 VAC/110 VAC

2. Contacts

- 1: SPDT
- 2: DPDT

5. Socket (Solder Terminals Only)

M16-□
1

1. Voltage Reduction Circuit

(Operating Voltage/Rated Voltage)

- 0: Without Voltage Reduction Unit
- T1: 100 VAC/110 VAC

Ordering Information

List of Models

Ordering as a Set

The model numbers used to order sets of Units are given in the following tables. One set comprises the Pushbutton, Lamp (lighted models only), Case, and Switch.

A16□-J (Rectangular) Models

Solder Terminal Models

IP40

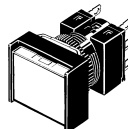

Output	Lighting	Operating voltage	Momentary operation (Self-resetting)	Alternate operation (Self-holding)	Pushbutton color symbol (See note 1.)			
SPDT	LED without Voltage Reduction Unit	5 VDC	A16L-J□M-5D-1	A16L-J□A-5D-1	R: red Y: yellow PY: pure yellow G: green A: blue W: white			
		12 VDC	A16L-J□M-12D-1	A16L-J□A-12D-1				
		24 VDC	A16L-J□M-24D-1	A16L-J□A-24D-1				
	Incandescent lamp	5 VDC/VAC	A16L-J□M-5-1	A16L-J□A-5-1		R: red Y: yellow PY: pure yellow G: green W: white A: blue B: black (See note 2.)		
		12 VDC/VAC	A16L-J□M-12-1	A16L-J□A-12-1				
		24 VDC/VAC	A16L-J□M-24-1	A16L-J□A-24-1				
	Non-lighted		A16-J□M-1	A16-J□A-1				
	DPDT	LED without Voltage Reduction Unit	5 VDC	A16L-J□M-5D-2			A16L-J□A-5D-2	R: red Y: yellow PY: pure yellow G: green A: blue W: white
			12 VDC	A16L-J□M-12D-2			A16L-J□A-12D-2	
24 VDC			A16L-J□M-24D-2	A16L-J□A-24D-2				
Incandescent lamp		5 VDC/VAC	A16L-J□M-5-2	A16L-J□A-5-2	R: red Y: yellow PY: pure yellow G: green W: white A: blue B: black (See note 2.)			
		12 VDC/VAC	A16L-J□M-12-2	A16L-J□A-12-2				
		24 VDC/VAC	A16L-J□M-24-2	A16L-J□A-24-2				
Non-lighted		A16-J□M-2	A16-J□A-2					

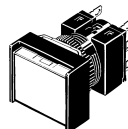

IP65 Oil-resistant

Output	Lighting	Operating voltage	Momentary operation (Self-resetting)	Alternate operation (Self-holding)	Pushbutton color symbol (See note 1.)			
SPDT	LED without Voltage Reduction Unit	5 VDC	A165L-J□M-5D-1	A165L-J□A-5D-1	R: red Y: yellow PY: pure yellow G: green A: blue W: white			
		12 VDC	A165L-J□M-12D-1	A165L-J□A-12D-1				
		24 VDC	A165L-J□M-24D-1	A165L-J□A-24D-1				
	Incandescent lamp	5 VDC/VAC	A165L-J□M-5-1	A165L-J□A-5-1		R: red Y: yellow PY: pure yellow G: green W: white A: blue B: black (See note 2.)		
		12 VDC/VAC	A165L-J□M-12-1	A165L-J□A-12-1				
		24 VDC/VAC	A165L-J□M-24-1	A165L-J□A-24-1				
	Non-lighted		A165-J□M-1	A165-J□A-1				
	DPDT	LED without Voltage Reduction Unit	5 VDC	A165L-J□M-5D-2			A165L-J□A-5D-2	R: red Y: yellow PY: pure yellow G: green A: blue W: white
			12 VDC	A165L-J□M-12D-2			A165L-J□A-12D-2	
24 VDC			A165L-J□M-24D-2	A165L-J□A-24D-2				
Incandescent lamp		5 VDC/VAC	A165L-J□M-5-2	A165L-J□A-5-2	R: red Y: yellow PY: pure yellow G: green W: white A: blue B: black (See note 2.)			
		12 VDC/VAC	A165L-J□M-12-2	A165L-J□A-12-2				
		24 VDC/VAC	A165L-J□M-24-2	A165L-J□A-24-2				
Non-lighted		A165-J□M-2	A165-J□A-2					

Note: 1. Enter the desired color symbol for the Pushbutton in the □.

2. Black ("B") Pushbuttons are only available for non-lighted models.

A16□-A (Square) Models

Solder Terminal Models

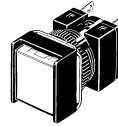

IP40

Output	Lighting	Operating voltage	Momentary operation (Self-resetting)	Alternate operation (Self-holding)	Pushbutton color symbol (See note 1.)			
SPDT	LED without Voltage Reduction Unit	5 VDC	A16L-A□M-5D-1	A16L-A□A-5D-1	R: red Y: yellow PY: pure yellow G: green A: blue W: white			
		12 VDC	A16L-A□M-12D-1	A16L-A□A-12D-1				
		24 VDC	A16L-A□M-24D-1	A16L-A□A-24D-1				
	Incandescent lamp	5 VDC/VAC	A16L-A□M-5-1	A16L-A□A-5-1		R: red Y: yellow PY: pure yellow G: green W: white A: blue B: black (See note 2.)		
		12 VDC/VAC	A16L-A□M-12-1	A16L-A□A-12-1				
		24 VDC/VAC	A16L-A□M-24-1	A16L-A□A-24-1				
	Non-lighted		A16-A□M-1	A16-A□A-1				
	DPDT	LED without Voltage Reduction Unit	5 VDC	A16L-A□M-5D-2			A16L-A□A-5D-2	R: red Y: yellow PY: pure yellow G: green A: blue W: white
			12 VDC	A16L-A□M-12D-2			A16L-A□A-12D-2	
24 VDC			A16L-A□M-24D-2	A16L-A□A-24D-2				
Incandescent lamp		5 VDC/VAC	A16L-A□M-5-2	A16L-A□A-5-2	R: red Y: yellow PY: pure yellow G: green W: white A: blue B: black (See note 2.)			
		12 VDC/VAC	A16L-A□M-12-2	A16L-A□A-12-2				
		24 VDC/VAC	A16L-A□M-24-2	A16L-A□A-24-2				
Non-lighted		A16-A□M-2	A16-A□A-2					

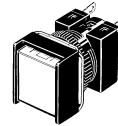

IP65 Oil-resistant

Output	Lighting	Operating voltage	Momentary operation (Self-resetting)	Alternate operation (Self-holding)	Pushbutton color symbol (See note 1.)			
SPDT	LED without Voltage Reduction Unit	5 VDC	A165L-A□M-5D-1	A165L-A□A-5D-1	R: red Y: yellow PY: pure yellow G: green A: blue W: white			
		12 VDC	A165L-A□M-12D-1	A165L-A□A-12D-1				
		24 VDC	A165L-A□M-24D-1	A165L-A□A-24D-1				
	Incandescent lamp	5 VDC/VAC	A165L-A□M-5-1	A165L-A□A-5-1		R: red Y: yellow PY: pure yellow G: green W: white A: blue B: black (See note 2.)		
		12 VDC/VAC	A165L-A□M-12-1	A165L-A□A-12-1				
		24 VDC/VAC	A165L-A□M-24-1	A165L-A□A-24-1				
	Non-lighted		A165-A□M-1	A165-A□A-1				
	DPDT	LED without Voltage Reduction Unit	5 VDC	A165L-A□M-5D-2			A165L-A□A-5D-2	R: red Y: yellow PY: pure yellow G: green A: blue W: white
			12 VDC	A165L-A□M-12D-2			A165L-A□A-12D-2	
24 VDC			A165L-A□M-24D-2	A165L-A□A-24D-2				
Incandescent lamp		5 VDC/VAC	A165L-A□M-5-2	A165L-A□A-5-2	R: red Y: yellow PY: pure yellow G: green W: white A: blue B: black (See note 2.)			
		12 VDC/VAC	A165L-A□M-12-2	A165L-A□A-12-2				
		24 VDC/VAC	A165L-A□M-24-2	A165L-A□A-24-2				
Non-lighted		A165-A□M-2	A165-A□A-2					

- Note:**
1. Enter the desired color symbol for the Pushbutton in the □.
 2. Black ("B") Pushbuttons are only available for non-lighted models.

A16□-T (Round) Models

Solder Terminals



IP40

Output	Lighting	Operating voltage	Momentary operation (Self-resetting)	Alternate operation (Self-holding)	Pushbutton color symbol (See note 1.)	
SPDT	LED without Voltage Reduction Unit	5 VDC	A16L-T□M-5D-1	A16L-T□A-5D-1	R: red Y: yellow PY: pure yellow G: green A: blue W: white	
		12 VDC	A16L-T□M-12D-1	A16L-T□A-12D-1		
		24 VDC	A16L-T□M-24D-1	A16L-T□A-24D-1		
	Incandescent lamp	5 VDC/VAC	A16L-T□M-5-1	A16L-T□A-5-1	R: red Y: yellow PY: pure yellow G: green W: white A: blue B: black (See note 2.)	
		12 VDC/VAC	A16L-T□M-12-1	A16L-T□A-12-1		
		24 VDC/VAC	A16L-T□M-24-1	A16L-T□A-24-1		
	Non-lighted			A16-T□M-1	A16-T□A-1	
	DPDT	LED without Voltage Reduction Unit	5 VDC	A16L-T□M-5D-2	A16L-T□A-5D-2	R: red Y: yellow PY: pure yellow G: green A: blue W: white
			12 VDC	A16L-T□M-12D-2	A16L-T□A-12D-2	
24 VDC			A16L-T□M-24D-2	A16L-T□A-24D-2		
Incandescent lamp		5 VDC/VAC	A16L-T□M-5-2	A16L-T□A-5-2	R: red Y: yellow PY: pure yellow G: green W: white A: blue B: black (See note 2.)	
		12 VDC/VAC	A16L-T□M-12-2	A16L-T□A-12-2		
		24 VDC/VAC	A16L-T□M-24-2	A16L-T□A-24-2		
Non-lighted			A16-T□M-2	A16-T□A-2		



IP65 Oil-resistant

Output	Lighting	Operating voltage	Momentary operation (Self-resetting)	Alternate operation (Self-holding)	Pushbutton color symbol (See note 1.)	
SPDT	LED without Voltage Reduction Unit	5 VDC	A165L-T□M-5D-1	A165L-T□A-5D-1	R: red Y: yellow PY: pure yellow G: green A: blue W: white	
		12 VDC	A165L-T□M-12D-1	A165L-T□A-12D-1		
		24 VDC	A165L-T□M-24D-1	A165L-T□A-24D-1		
	Incandescent lamp	5 VDC/VAC	A165L-T□M-5-1	A165L-T□A-5-1	R: red Y: yellow PY: pure yellow G: green W: white A: blue B: black (See note 2.)	
		12 VDC/VAC	A165L-T□M-12-1	A165L-T□A-12-1		
		24 VDC/VAC	A165L-T□M-24-1	A165L-T□A-24-1		
	Non-lighted			A165-T□M-1	A165-T□A-1	
	DPDT	LED without Voltage Reduction Unit	5 VDC	A165L-T□M-5D-2	A165L-T□A-5D-2	R: red Y: yellow PY: pure yellow G: green A: blue W: white
			12 VDC	A165L-T□M-12D-2	A165L-T□A-12D-2	
24 VDC			A165L-T□M-24D-2	A165L-T□A-24D-2		
Incandescent lamp		5 VDC/VAC	A165L-T□M-5-2	A165L-T□A-5-2	R: red Y: yellow PY: pure yellow G: green W: white A: blue B: black (See note 2.)	
		12 VDC/VAC	A165L-T□M-12-2	A165L-T□A-12-2		
		24 VDC/VAC	A165L-T□M-24-2	A165L-T□A-24-2		
Non-lighted			A165-T□M-2	A165-T□A-2		

- Note:** 1. Enter the desired color symbol for the Pushbutton in the □.
 2. Black ("B") Pushbuttons are only available for non-lighted models.

Other Models

Models with Reduced-voltage Lighting and Solder Terminals

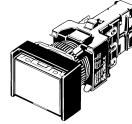

IP40

Output	Lighting	Operating voltage	Momentary operation (Self-resetting)	Alternate operation (Self-holding)	Pushbutton color symbol (See note 1.)
SPDT	LED (with built-in reduced-voltage lighting function)	100/110 VAC/VDC	A16L-Δ□M-T1-1	A16L-Δ□A-T1-1	R: red Y: yellow PY: pure yellow G: green W: white A: blue
DPDT		100/110 VAC/VDC	A16L-Δ□M-T1-2	A16L-Δ□A-T1-2	

IP65

Output	Lighting	Operating voltage	Momentary operation (Self-resetting)	Alternate operation (Self-holding)	Pushbutton color symbol (See note 1.)
SPDT	LED (with built-in reduced-voltage lighting function)	100/110 VAC/VDC	A165L-Δ□M-T1-1	A165L-Δ□A-T1-1	R: red Y: yellow PY: pure yellow G: green W: white A: blue
DPDT		100/110 VAC/VDC	A165L-Δ□M-T1-2	A165L-Δ□A-T1-2	

- Note:** 1. Enter the desired shape for the Pushbutton in Δ: J (rectangular), A (square), or T (round). Enter the desired color symbol for the Pushbutton in the □.
 2. Models with rated voltage 200 to 220 VAC/VDC (T2 models) are only available with Screw-Less Clamps.

Screw-Less Clamp Models

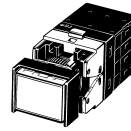

IP40

Output	Lighting	Operating voltage	Momentary operation (Self-resetting)	Alternate operation (Self-holding)	Pushbutton color symbol (See note 1.)
DPDT	LED	5 VDC	A16L-Δ□M-5D-2S	A16L-Δ□A-5D-2S	R: red Y: yellow PY: pure yellow G: green W: white A: blue B: black (See note 2.)
		12 VDC	A16L-Δ□M-12D-2S	A16L-Δ□A-12D-2S	
		24 VDC	A16L-Δ□M-24D-2S	A16L-Δ□A-24D-2S	
	LED (with built-in reduced-voltage lighting function)	100/110 VAC/VDC	A16L-Δ□M-T1-2S	A16L-Δ□A-T1-2S	
		200/220 VAC/VDC	A16L-Δ□M-T2-2S	A16L-Δ□A-T2-2S	
	Non-lighted		A16L-Δ□M-2S	A16L-Δ□A-2S	

IP65

Output	Lighting	Operating voltage	Momentary operation (Self-resetting)	Alternate operation (Self-holding)	Pushbutton color symbol (See note 1.)
DPDT	LED	5 VDC	A165L-Δ□M-5D-2S	A165L-Δ□A-5D-2S	R: red Y: yellow PY: pure yellow G: green W: white A: blue B: black (See note 2.)
		12 VDC	A165L-Δ□M-12D-2S	A165L-Δ□A-12D-2S	
		24 VDC	A165L-Δ□M-24D-2S	A165L-Δ□A-24D-2S	
	LED (with built-in reduced-voltage lighting function)	100/110 VAC/VDC	A165L-Δ□M-T1-2S	A165L-Δ□A-T1-2S	
		200/220 VAC/VDC	A165L-Δ□M-T2-2S	A165L-Δ□A-T2-2S	
	Non-lighted		A165L-Δ□M-2S	A165L-Δ□A-2S	

- Note:** 1. Enter the desired shape for the Pushbutton in Δ: J (rectangular), A (square), or T (round). Enter the desired color symbol for the Pushbutton in the □.
 2. Black ("B") Pushbuttons are only available for non-lighted models.

A165□-BA (24-mm Square) Models

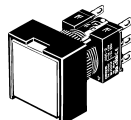

Solder Terminals

IP65

Output	Lighting	Operating voltage	Momentary operation (Self-resetting)	Alternate operation (Self-holding)	Pushbutton color symbol (See note 1.)
SPDT	LED	5 VDC	A165L-BA□M-5D-1	A165L-BA□A-5D-1	R: red Y: yellow PY: pure yellow G: green W: white A: blue B: black (See note 2.)
	LED	12 VDC	A165L-BA□M-12D-1	A165L-BA□A-12D-1	
	LED	24 VDC	A165L-BA□M-24D-1	A165L-BA□A-24D-1	
	Non-lighted		A165-BA□M-1	A165-BA□A-1	
DPDT	LED	5 VDC	A165L-BA□M-5D-2	A165L-BA□A-5D-2	
	LED	12 VDC	A165L-BA□M-12D-2	A165L-BA□A-12D-2	
	LED	24 VDC	A165L-BA□M-24D-2	A165L-BA□A-24D-2	
	Non-lighted		A165-BA□M-2	A165-BA□A-2	

- Note:**
1. Enter the desired color symbol for the Pushbutton in the □.
 2. Black ("B") Pushbuttons are only available for non-lighted models.

Ordering Individually

Pushbuttons, Lamps, Cases, and Switches (Sockets) can be ordered separately. Combinations that are not available as sets can be created using individual Units. Also, store the parts as spares for maintenance and repairs.

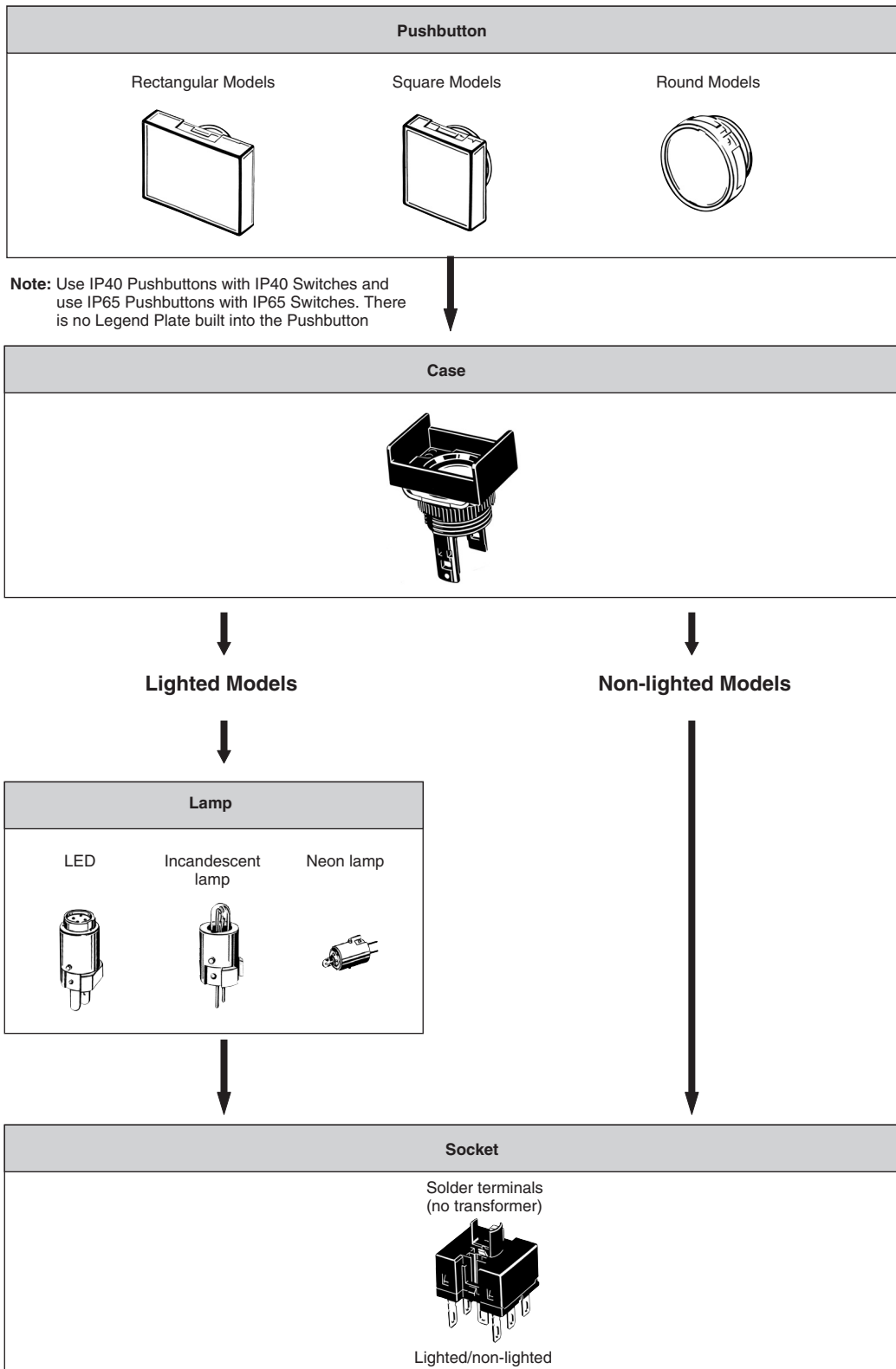







Pushbutton Switches







Pushbuttons

Illumination: red, yellow, and white use either LED or incandescent lamps.







LED

Degree of protection	IP40			Oil-resistant IP65		
	Rectangular 	Square 	Round 	Rectangular 	Square 	Round 
Red	A16L-JR	A16L-AR	A16L-TR	A165L-JR	A165L-AR	A165L-TR
Yellow	A16L-JY	A16L-AY	A16L-TY	A165L-JY	A165L-AY	A165L-TY
Pure yellow	A16L-JPY	A16L-APY	A16L-TPY	A165L-JPY	A165L-APY	A165L-TPY
Green	A16L-JGY	A16L-AGY	A16L-TGY	A165L-JGY	A165L-AGY	A165L-TGY
White	A16L-JW	A16L-AW	A16L-TW	A165L-JW	A165L-AW	A165L-TW
Blue	A16L-JA	A16L-AA	A16L-TA	A165L-JA	A165L-AA	A165L-TA







Incandescent Lamps (With the exception of green, the Units are the same as for LEDs.)

Degree of protection	IP40			Oil-resistant IP65		
	Rectangular 	Square 	Round 	Rectangular 	Square 	Round 
Red	A16L-JR	A16L-AR	A16L-TR	A165L-JR	A165L-AR	A165L-TR
Yellow	A16L-JY	A16L-AY	A16L-TY	A165L-JY	A165L-AY	A165L-TY
Pure yellow	A16L-JPY	A16L-APY	A16L-TPY	A165L-JPY	A165L-APY	A165L-TPY
Green	A16L-JG	A16L-AG	A16L-TG	A165L-JG	A165L-AG	A165L-TG
White	A16L-JW	A16L-AW	A16L-TW	A165L-JW	A165L-AW	A165L-TW
Blue	A16L-JA	A16L-AA	A16L-TA	A165L-JA	A165L-AA	A165L-TA



Non-lighted (Same as Units for incandescent lamps.)

Degree of protection	IP40			Oil-resistant IP65		
	Rectangular 	Square 	Round 	Rectangular 	Square 	Round 
Red	A16L-JR	A16L-AR	A16L-TR	A165L-JR	A165L-AR	A165L-TR
Yellow	A16L-JY	A16L-AY	A16L-TY	A165L-JY	A165L-AY	A165L-TY
Pure yellow	A16L-JPY	A16L-APY	A16L-TPY	A165L-JPY	A165L-APY	A165L-TPY
Green	A16L-JG	A16L-AG	A16L-TG	A165L-JG	A165L-AG	A165L-TG
White	A16L-JW	A16L-AW	A16L-TW	A165L-JW	A165L-AW	A165L-TW
Blue	A16L-JA	A16L-AA	A16L-TA	A165L-JA	A165L-AA	A165L-TA
Black	A16L-JB	A16L-AB	A16L-TB	A165L-JB	A165L-AB	A165L-TB

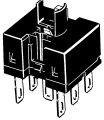
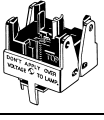

Neon Lamps

Degree of protection	IP40			Oil-resistant IP65		
	Rectangular 	Square 	Round 	Rectangular 	Square 	Round 
Red	A16L-JRN	A16L-ARN	A16L-TRN	A165L-JRN	A165L-ARN	A165L-TRN
Green	A16L-JGN	A16L-AGN	A16L-TGN	A165L-JGN	A165L-AGN	A165L-TGN
White	A16L-JWN	A16L-AWN	A16L-TWN	A165L-JWN	A165L-AWN	A165L-TWN

Switches

Appearance	Classification			Model	
	Lighted/non-lighted (common use)	Standard load/microload (common use)	SPDT	Solder terminal	A16-1
			DPDT		A16-2
			SPDT	PCB terminal	A16-1P
			DPDT		A16-2P
			DPDT	Screw-Less Clamp	A16-2S

Switches with Reduced-voltage Lighting

Appearance	Classification			Model	
	100 V	Standard load/microload (common use)	SPDT	Solder terminal	A16-T1-1
			DPDT		A16-T1-2
	100 V 200 V		DPDT	Screw-less clamp	A16-T1-2S A16-T2-2S

Lamps

LED

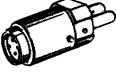
Operating voltage	5 VDC	12 VDC	24 VDC
 Light color			
Red	A16-5DSR	A16-12DSR	A16-24DSR
Yellow	A16-5DSY	A16-12DSY	A16-24DSY
Green	A16-5DSG	A16-12DSG	A16-24DSG
White (See note.)	A16-5DSW	A16-12DSW	A16-24DSW
Blue	A16-5DA	A16-12DA	A16-24DA

Note: Use the white LED together with white or pure yellow Pushbuttons.

Incandescent Lamp

Operating voltage	5 VAC/VDC	12 VAC/VDC	24 VAC/VDC
			
Model	A16-5	A16-12	A16-24

Neon Lamp

Operating voltage	100 VAC	200 VAC
		
Red (See note.)	A16-1NRN	A16-2NRN
Green	A16-1NGN	A16-2NGN



Note: Use the red neon lamp with red or white Pushbuttons.

Cases





Appearance	Classification			Model
	IP40	Momentary operation	Rectangular (2-way guard)	A16-CJM
			Rectangular (3-way guard)	A16-C3JM
			Square	A16-CAM
			Round	A16-CTM
		Alternate operation	Rectangular (2-way guard)	A16-CJA
			Rectangular (3-way guard)	A16-C3JA
			Square	A16-CAA
			Round	A16-CTA
	Oil-resistant IP65	Momentary operation	Rectangular (2-way guard)	A165-CJM
			Rectangular (3-way guard)	A165-C3JM
			Square	A165-CAM
		Alternate operation	Round	A165-CTM
			Rectangular (2-way guard)	A165-CJA
			Rectangular (3-way guard)	A165-C3JA
	Square	A165-CAA		
	Round	A165-CTA		

Accessories (Order Separately)

Accessories



Name	Appearance	Classification	Model	Remarks
Switch Guards		For rectangular models	A16ZJ-5050	Cannot be used with the Dust Cover.
		For square and round models	A16ZA-5050	
Dust Covers		For rectangular models	A16ZJ-5060	Cannot be used with the Switch Guard.
		For square models	A16ZA-5060	
		For round models	A16ZT-5060	
Panel Plugs		For rectangular models	A16ZJ-3003	Used for covering the panel cutouts for future panel expansion.
		For square models	A16ZA-3003	
		For round models	A16ZT-3003	

Replacements

Name	Appearance	Classification		Model	Remarks		
Legend Plates		Rectangular	IP40	Milky	A16ZJ-5204	A single Legend Plate (transparent) is included with a standard model. The milky Legend Plate can be used with the IP40 and oil-resistant IP65.	
				Transparent	A16ZJ-5202		
			Oil-resistant IP65	Milky	A16ZJ-5204		
				Transparent	A16ZJ-5203		
			Square	IP40	Milky		A16ZA-5204
					Transparent		A16ZA-5202
		Oil-resistant IP65		Milky	A16ZA-5204		
				Transparent	A16ZA-5203		
		Round	IP40	Milky	A16ZT-5204		
				Transparent	A16ZT-5202		
			Oil-resistant IP65	Milky	A16ZT-5204		
				Transparent	A16ZT-5203		
Color Caps (for IP40)	Rectangular 	LED indicator/incandescent lamp/non-lighted	White	A16Z□-5001W	Insert one of the following letters into the box (□). J: Rectangular A: Square T: Round The Color Cap is usually supplied. Replace the Cap if the color is to be changed. When using an LED indicator, be sure to use a Color Cap that matches the luminescent color of the LED. The materials used for the IP40 and oil-resistant IP65 are different so be sure to use a Color Cap that matches the specifications of the Switch.		
			Red	A16Z□-5001R			
			Yellow	A16Z□-5001Y			
		LED indicator	Pure yellow	A16Z□-5001PY			
			Green	A16Z□-5001GY			
			Incandescent lamp/non-lighted	Blue		A16Z□-5001A	
	Green	A16Z□-5001G					
	Square 	Non-lighted	Black	A16Z□-5011B			
			LED indicator/incandescent lamp/non-lighted	White		A16Z□-5101W	
		Red		A16Z□-5101R			
Yellow		A16Z□-5101Y					
Round 	LED indicator	Pure yellow	A16Z□-5101PY				
		Green	A16Z□-5101GY				
	Incandescent lamp/non-lighted	Blue	A16Z□-5101A				
		Green	A16Z□-5101G				
Non-lighted	Black	A16Z□-5111B					

Pushbutton Switches

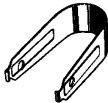
Tools

Name	Appearance	Model	Applicable types					Remarks
			Pushbutton Switch	Knob-type Selector Switch	Key-type Selector Switch	Emergency Stop Switch	Indicator	
Extractor		A3PJ-5080	Yes	No	No	No	Yes	Convenient for extracting Pushbutton Switches
Screw Fitting		A16Z-3004	Yes	Yes	Yes	Yes	Yes	Convenient for ganged installation. Tighten to a torque of 0.39 N · m min.
Extractor		A16Z-5080	Yes	Yes	Yes	Yes	Yes	Convenient for extracting the Switch and Lamps.

Specifications

■ Approved Standards

Agency	Standards	File No.
UL, cUL (See note.)	UL508	E41515
---	EN60947-5-1	---

Note: cUL: CSA, C22.2 No. 14

■ Approved Standard Ratings

UL, cUL (File No. E41515)

5 A at 125 VAC, 3 A at 250 VAC (general use)
3 A at 30 VDC (resistive)

EN60947-5-1 (Low Voltage Directive)

3 A at 250 VAC (AC12), 3 A at 30 VDC (DC12)

■ Ratings

Contacts

AC resistive load	DC resistive load
3 A at 250 VAC 5 A at 125 VAC	3 A at 30 VDC

Minimum applicable load: 1 mA at 5 VDC

Rated values are obtained from tests conducted under the following conditions.

1. Load: Resistive load
2. Mounting conditions: No vibration and no shock
3. Temperature: 20±2°C
4. Operating frequency: 20 operations/min

Super-bright LED

Rated voltage	Rated current	Operating voltage	Internal limiting resistor
5 VDC	30 mA (15 mA)	5 VDC±5%	33 Ω (68 Ω)
12 VDC	15 mA	12 VDC±5%	270 Ω (560 Ω)
24 VDC	10 mA	24 VDC±5%	1600 Ω (2,000 Ω)

Note: The values in parentheses are for models with blue Pushbuttons.

Incandescent Lamp

Rated voltage	Rated current	Operating voltage
6 VAC/VDC	60 mA	5 VAC/VDC
14 VAC/VDC	40 mA	12 VAC/VDC
28 VAC/VDC	24 mA	24 VAC/VDC

■ Characteristics

Item		Pushbutton Switch
Allowable operating frequency	Mechanical	Momentary operation: 120 operations/minute max. (See note 1.) Alternate operation: 60 operations/minute max. (See note 1.)
	Electrical	20 operations/minute max. (See note 1.)
Insulation resistance		100 MΩ min. (at 500 VDC)
Dielectric strength		1,000 VAC, 50/60 Hz for 1 min between terminals of same polarity 2,000 VAC, 50/60 Hz for 1 min between terminals of different polarity and also between each terminal and ground 1,000 VAC, 50/60 Hz for 1 min between lamp terminals (See note 2.)
Vibration resistance	Malfunction	10 to 55 Hz, 1.5-mm double amplitude (malfunction within 1 ms)
Shock resistance	Mechanical	500 m/s ²
	Malfunction	150 m/s ² max. (malfunction within 1 ms)
Durability	Mechanical	Momentary operation: 2,000,000 operations min. Alternate operation: 200,000 operations min. (See note 1.)
	Electrical	100,000 operations min. (See note 1.)
Ambient temperature		Operating: -10°C to 55°C (with no icing or condensation) Storage: -25°C to 65°C (with no icing or condensation)
Ambient humidity		Operating: 35% to 85%
Electric shock protection class		Class II
PTI (tracking characteristic)		175
Degree of contamination		3 (IEC947-5-1)
Weight		Approx. 10 g (in the case of a lighted DPDT switch with solder terminals)

- Note: 1. Set and reset constitute one operation.
2. With LED and incandescent lamp not mounted.

Screw-Less Clamp

Item		Screw-Less Clamp			
Recommended wire size		0.5 mm ² twisted wire or 0.8 mm-dia. solid wire			
Usable wires and tensile strength	Twisted wire	0.3 mm ²	0.5 mm ²	0.75 mm ²	1.25 mm ²
	Solid wire	0.5 mm dia.	0.8 mm dia.	1.0 mm dia.	---
	Tensile strength	10 N	20 N	30 N	40 N
Length of exposed wire		10 ±1 mm			

■ Operating Characteristics

Features	Type	Pushbutton Switch			
		IP40		Oil-resistant IP65	
		SPDT	DPDT	SPDT	DPDT
Operating force (OF) max.		2.45 N	4.41 N	2.94 N	4.91 N
Releasing force (RF) min.		0.29 N			
Total travel (TT)		Approx. 3 mm			
Pretravel (PT) max.		2.5 mm			
Lock stroke (LTA) min. (See note.)		0.5 mm			

Note: Lock stroke is only for alternate operation.

■ Contact Form

Name	Contact
DPDT	

Nomenclature

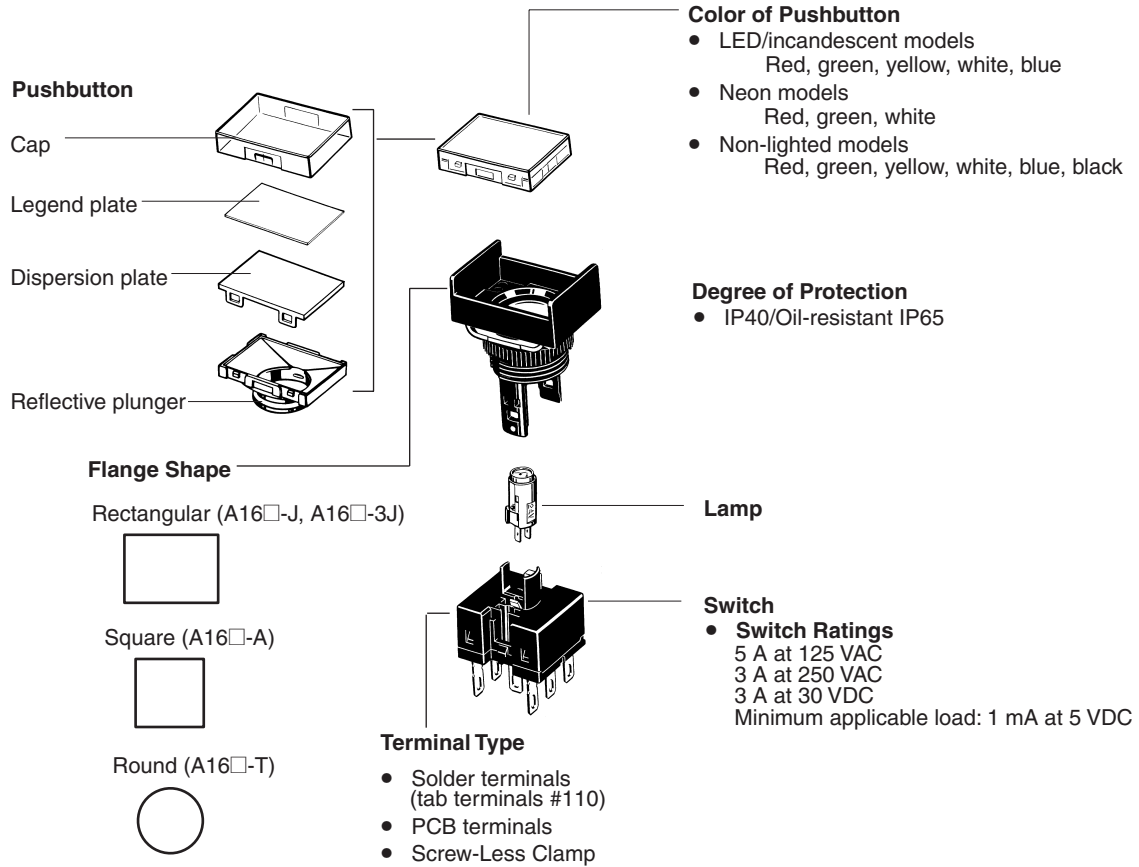

Dimensions

Note: All units are in millimeters unless otherwise indicated.

Lighted/Non-lighted Pushbutton Switches without Voltage Reduction Unit

The lamp terminal is also provided with non-lighted models.

Solder terminals and tab terminals (#110) can be both used with Lighted and Non-lighted Pushbutton Switches.

Rectangular

A16□-J

Solder terminals (tab terminals #110)

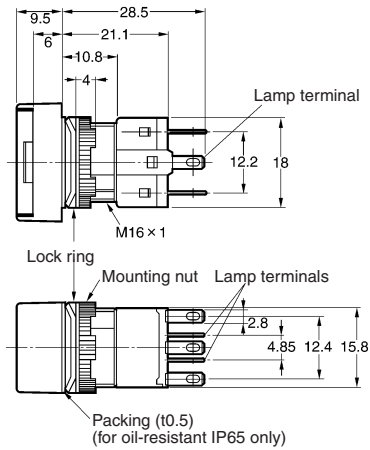
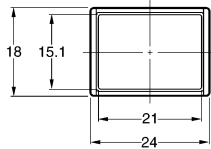
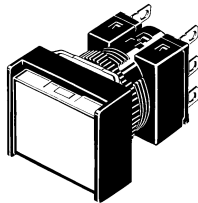

Panel Cutouts

See page 25 for panel cutouts

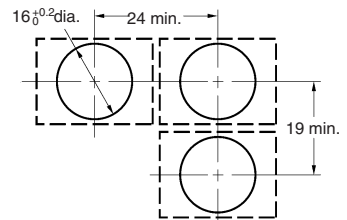

Square

A16□-A

Solder terminals (tab terminals #110)

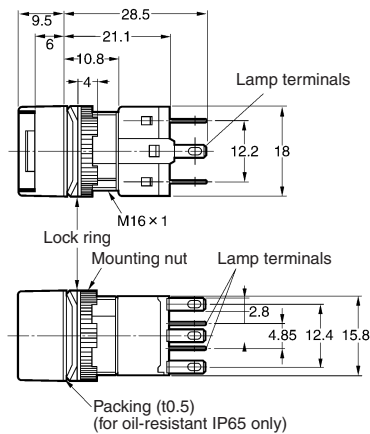
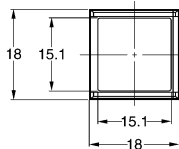
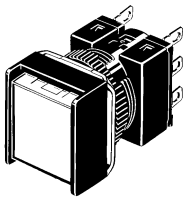

Panel Cutouts

See page 25 for panel cutouts

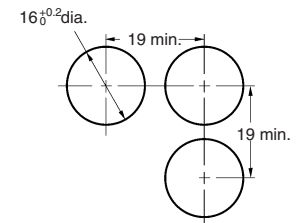

Rectangular

A16□-3J

Solder terminals (tab terminals #110)

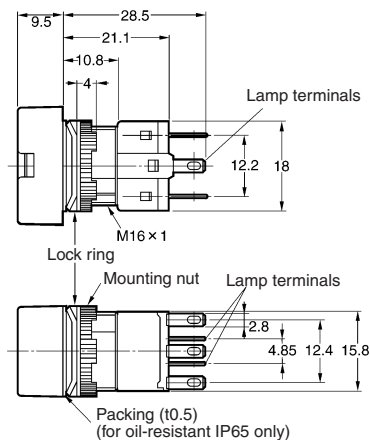
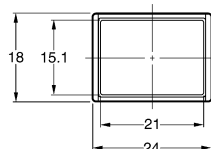
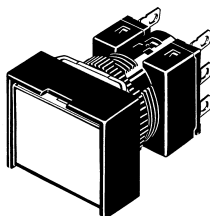

Panel Cutouts

See page 25 for panel cutouts

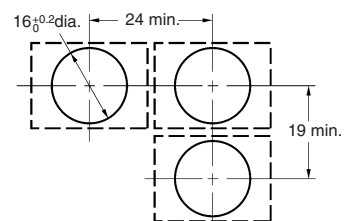

Pushbutton Switches

**Round
A16□-T**

Solder terminals (tab terminals #110)

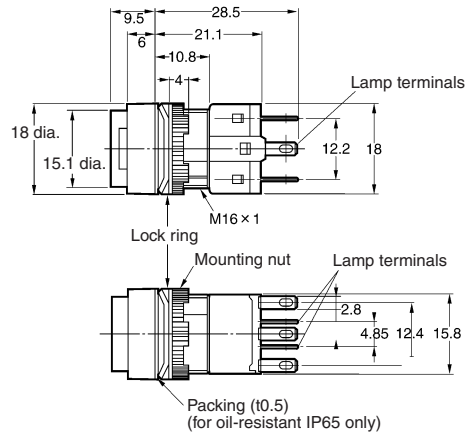
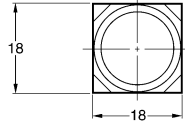
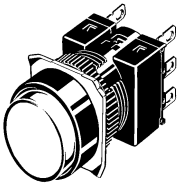

Panel Cutouts

See page 25 for panel cutouts

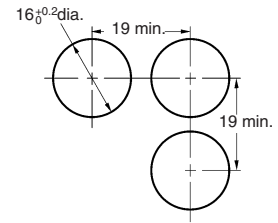

The following diagrams show the rectangular model as a representative example.

**Rectangular
A16□-J**
PCB terminals

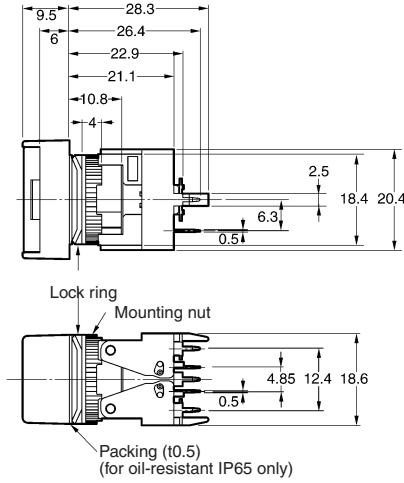
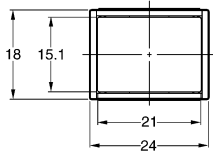
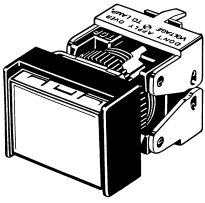

Panel Cutouts

See page 25 for panel cutouts

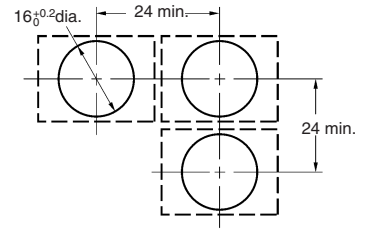

**Rectangular
A16□-T1, T2**
Voltage-reduction lighting,
solder terminals
(tab terminals #110)

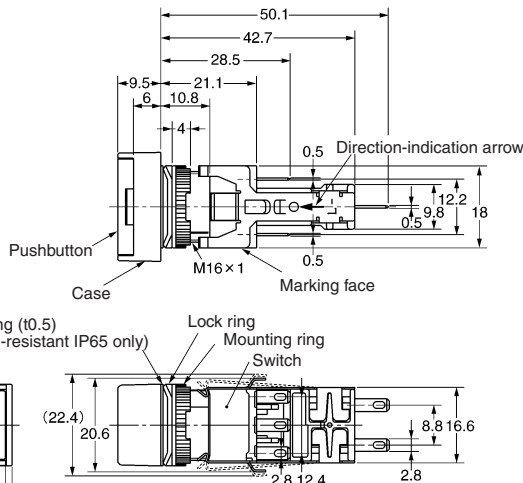
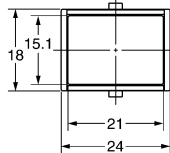
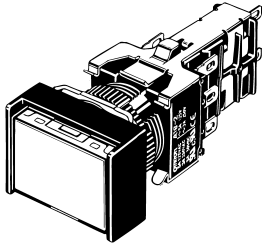

Panel Cutouts

See page 25 for panel cutouts

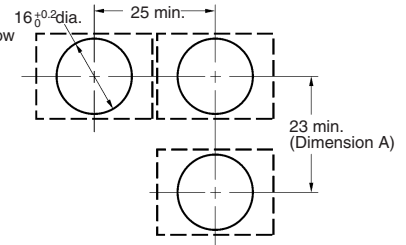

Recommended panel thickness: 0.5 to 3.2 mm

**Rectangular
A16□-2S**
Screw-Less Clamp

Screw-Less Clamp

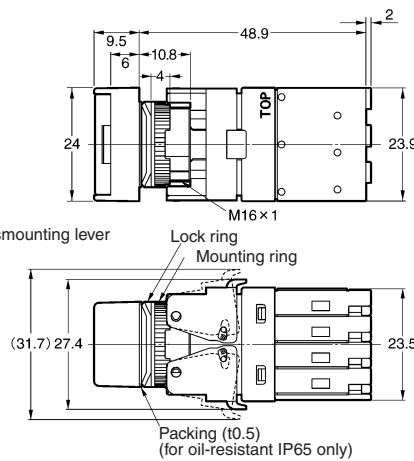
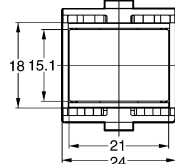
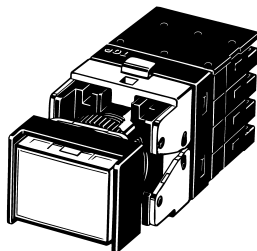

Panel Cutouts

See page 25 for panel cutouts

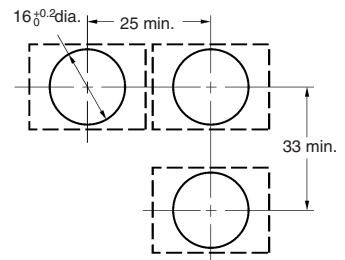

■ Lamps

LED
A16-5DS□/-12DS□/-24DS□

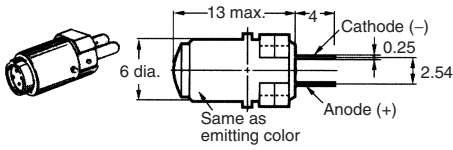

Incandescent Lamp
A16-5/-12/-24

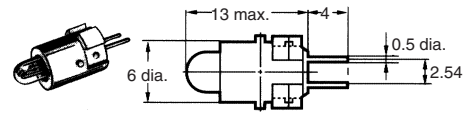

Neon Lamp
A16-1N/-2N

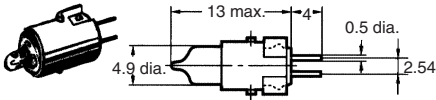

■ Accessories, Tools, and Components

Extractor
A3PJ-5080

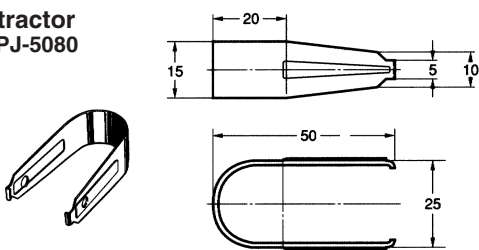

Legend Plates
A16ZJ-520□

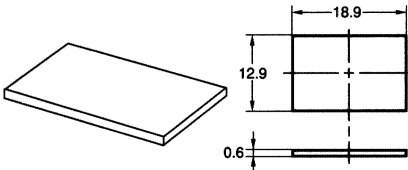

A16ZA-520□

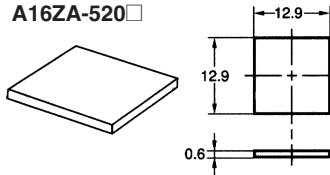

A16ZT-520□

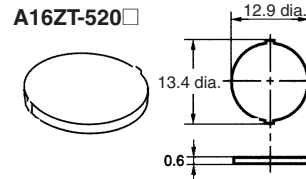

Note: 1. The panel is 0.6 mm thick.
2. The panel is made of the materials listed in the following table.

Color	Degree of protection	Materials
Milky	IP40	Polyacrylate resin
	IP65	
Transparent	IP40	Polycarbonate resin
	IP65	Polyacrylate resin

Note: The standard model is transparent.

Screw Fitting
A16Z-3004

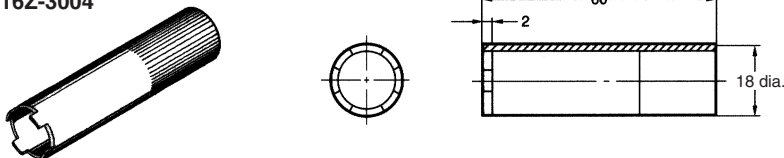

Panel Plugs (Black Resin)

Select the Plug that fits the panel design and mount from the front of the Panel. Panel cutouts are the same as those for Switches.

**Rectangular
A16ZJ-3003**

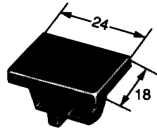

**Square
A16ZA-3003**

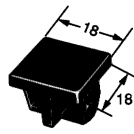

**Round
A16ZT-3003**

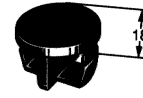

Lock Ring

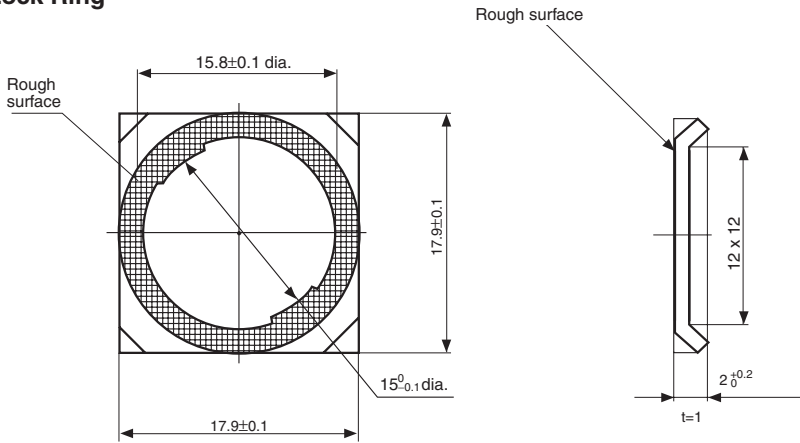

**Extractor
A16Z-5080**

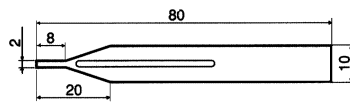
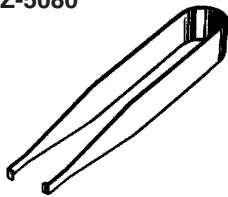

■ Dimensions with Accessories

Switch Guards

Rectangular A16ZJ-5050

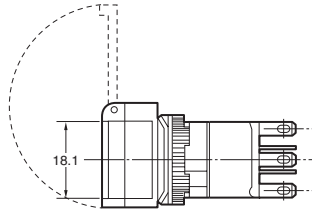
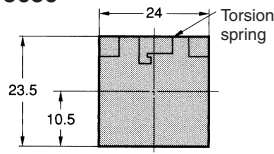

Panel Cutouts (Top View)

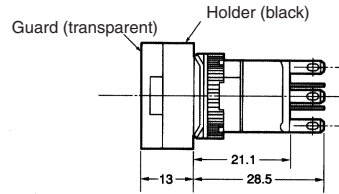
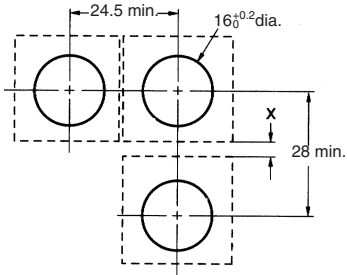

Note: The above illustration shows the case where 4.5 mm is provided for the distance "x." If no clearance is required for the "x" section, the vertical mounting dimension can be as small as 24 mm. Set this distance according to operating conditions.

Square A16ZA-5050

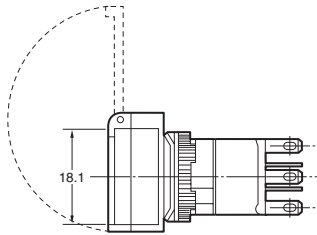
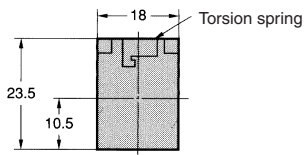

Panel Cutouts (Top View)

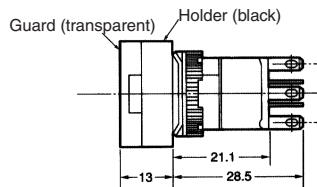
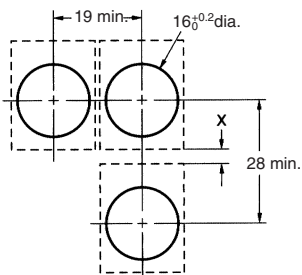

Note: The above illustration shows the case where 4.5 mm is provided for the distance "x." If no clearance is required for the "x" section, the vertical mounting dimension can be as small as 24 mm. Set this distance according to operating conditions. For models with PCB terminals, the horizontal mounting dimension is 24 mm min.

Dust Covers

**Rectangular
A16ZJ-5060**

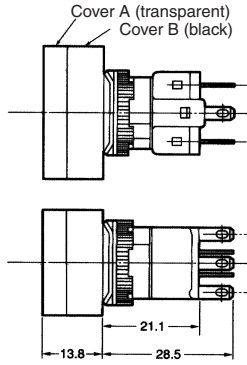
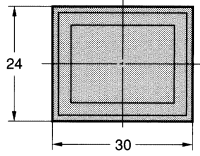

Panel Cutouts

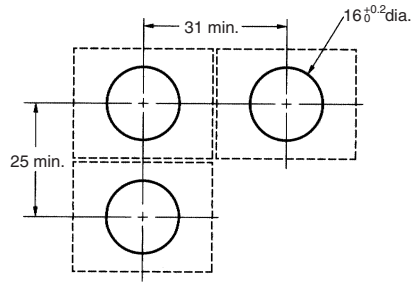

**Square
A16ZA-5060**

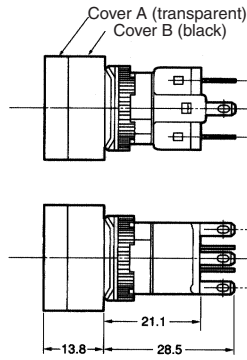
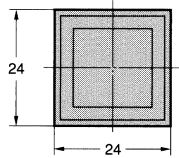

Panel Cutouts

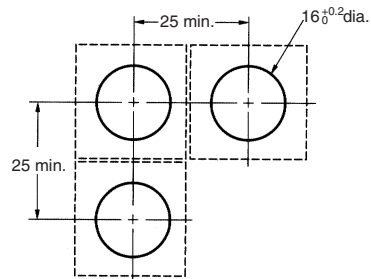

**Round
A16ZT-5050**

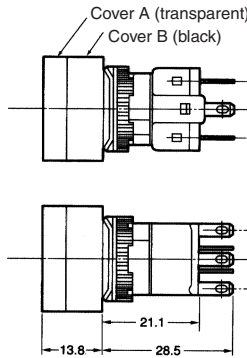
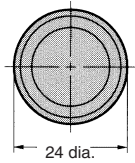

Panel Cutouts

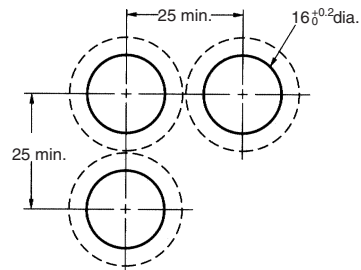

Terminal Arrangement

Models without Reduced-voltage Lighting

Non-lighted Pushbutton Switches are also provided with lamp terminals.

Solder Terminals

Lighted SPDT Switches

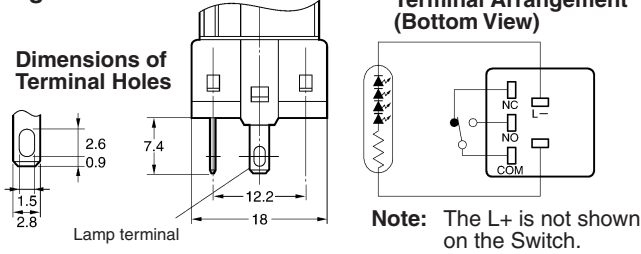

Lighted DPDT Switches

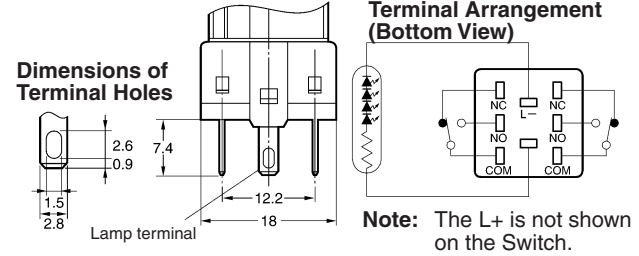

PCB Terminals

Lighted SPDT Switches

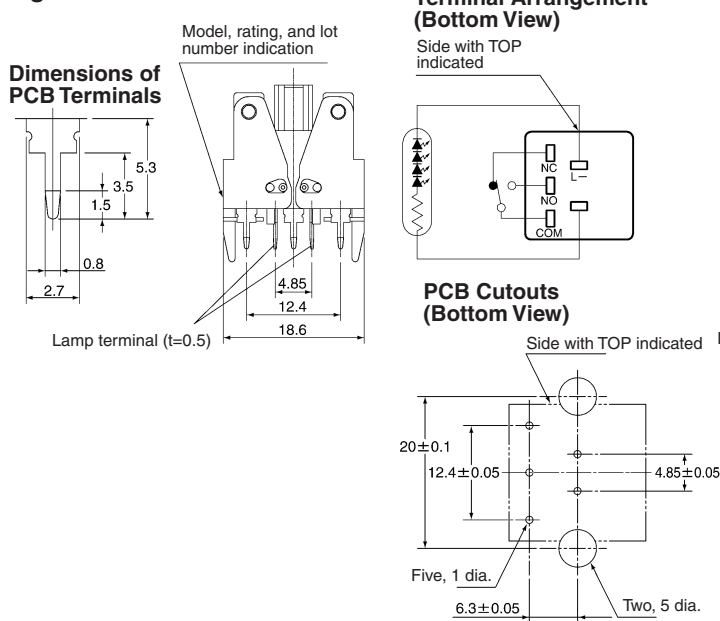

Lighted DPDT Switches

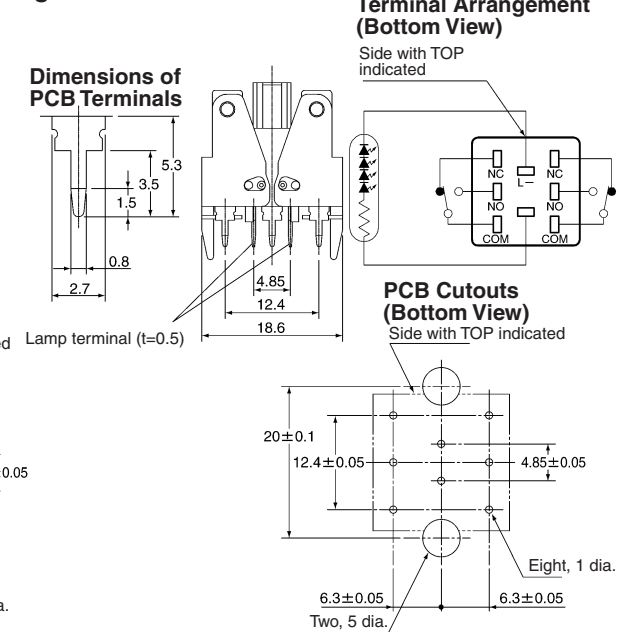

Voltage Reduction Units

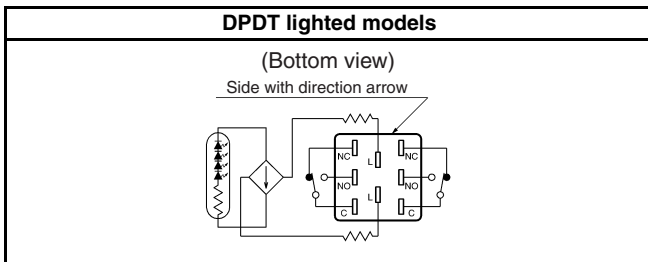

Screw-Less Clamps

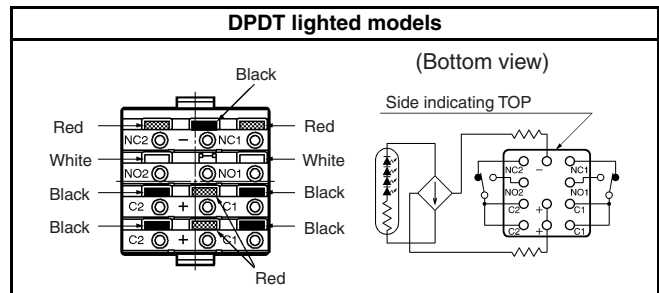

- Voltage-reduction lighting models with Screw-Less Clamps (A16L-□T1-2S, A16L-□T2-2S) incorporate voltage-reduction circuits.

■ Panel Cutouts

Solder Terminals

Rectangular A16□-J/M16□-□J
(Top View)

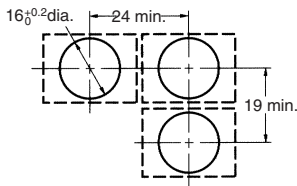

Square A16□-A/M16□-A
Round A16□-T/M16□-T
(Top View)

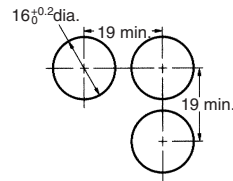

- Note:**
1. Make sure the thickness of the mounting panel is between 0.5 and 3.2 mm. If, however, a Switch Guard or Dust Cover is used, the thickness of the mounting panel must be between 0.5 and 2 mm.
 2. If the panel is to be finished with coating, etc., make sure that the panel meets the specified dimensions after coating.

PCB Terminals

Rectangular A16□-J/M16□-J
(Top View)

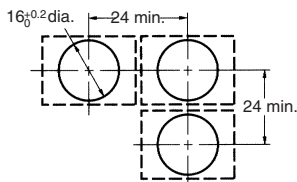

Square A16□-A/M16□-A, A165□-BA, M165-BA
Round A16□-T/M16□-T
(Top View)

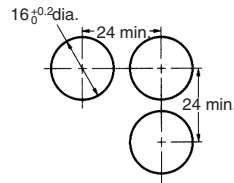

- Note:**
1. Ensure that the variation in the distance between the centers of neighboring mounting holes is less than ± 0.1 mm.
 2. Make sure the thickness of the mounting panel is between 0.5 and 3.2 mm. If, however, a Switch Guard or Dust Cover is used, the thickness of the mounting panel must be between 0.5 and 2 mm.
 3. If the panel is to be finished with coating, etc., make sure that the panel meets the specified dimensions after coating.

Installation

■ Panel Mounting

After mounting the Pushbutton Unit (i.e., the Pushbutton and the Case) to the panel, snap in the Switch Unit (i.e., the Switch and the Lamp) from the back of the panel.

Mounting to the Panel

Insert the Pushbutton Unit into the front of the panel, and fix the lock ring and mounting nut from the terminal side.

Make sure that the lock ring is aligned with the thread of the Case and the edge of the lock ring is touching the panel.

Tighten the mounting nuts to a torque of 0.29 to 0.49 N·m.

The maximum tightening torque is 0.49 N·m.

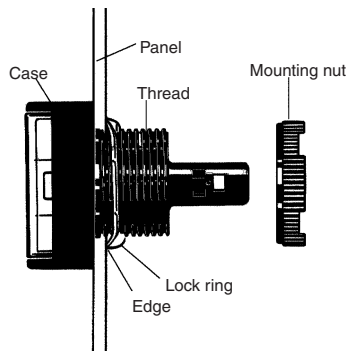

Mounting the Switch Unit

Snap on the Switch Unit to the Pushbutton Unit.

Make sure that the Switch Unit has the correct orientation when snapping it onto the Case. Align the • mark on the Case with the groove between the case guards on the NC terminal side of the Switch Unit in the way shown below, and push the Switch Unit into the Case until it clicks into place. Confirm that the Switch Unit is securely in place before using.

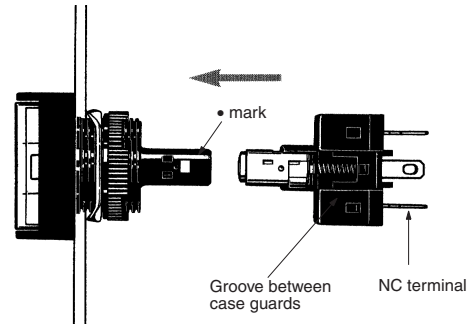

Mounting the Switch Unit for Voltage Reduction Types

1. The mounting panel thickness must be 0.5 to 3.2 mm.
2. The mounting ring must be tightened to a torque 0.29 to 0.49 N·m.
3. The mounting hole must be cut out in the way described previously. The dimension A is the length required for removing the Switch when it is in the mounted state. If Switches are mounted side-by-side separated by less than the specified distance, it may not be possible to remove the Switch.
4. Be sure to mount the Case to the Switch with the correct orientation. Mount with the • mark on the Case facing in the same direction as the side of the Switch with the direction arrow or the word TOP.

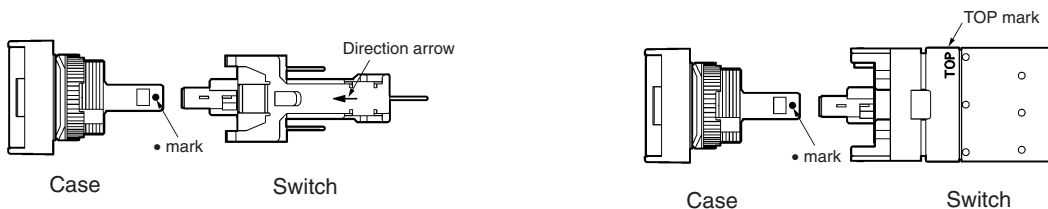

Removing the Switch Unit

Grip the part between the Switch holder of the Case and the Switch Unit using the A16Z-5080 Extractor, and pull to remove the Switch Unit.

- 16-mm Models

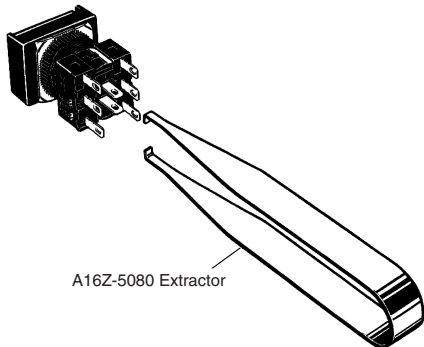

- A16-P Models (with PCB Terminals)

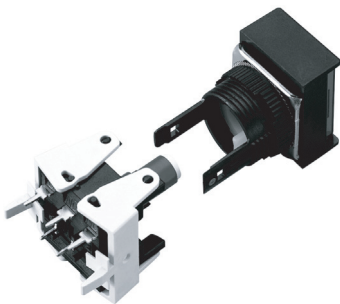

The Switch Unit can be mounted or dismounted by simply opening or closing the lever.

Mounting and Replacing the Pushbutton

Removing and Mounting the Pushbutton

1. Remove the Pushbutton as shown in the following diagram. If the Pushbutton cannot be removed by hand, use the A3PJ-5080 Extractor.

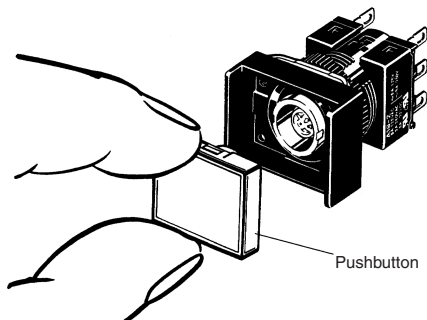

2. To attach the Pushbutton, push until it clicks into place.

Removing the Lamp

Removing from the Pushbutton End

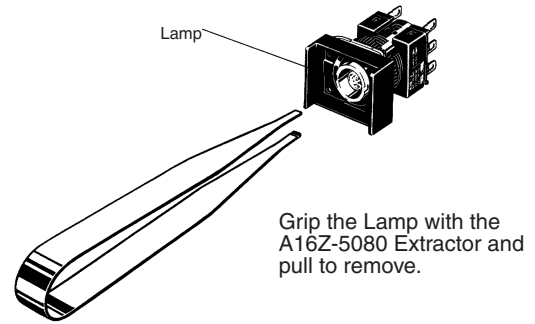

Removing from the Switch End

The Lamp can be removed by hand once the Switch is removed using the A16Z-5080 Extractor.

Installing the Lamp

When mounting the Lamp, make sure it is facing the direction shown in the following diagram. Insert the Lamp while matching the protruding part of the Lamp and the small guides on the outer surface of the Case.

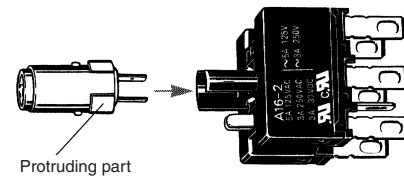

The Lamp can be mounted from the Pushbutton end by using the A16Z-5080 Extractor. The lamp can be mounted by following the opposite procedure for removing the Lamp.

■ Mounting the A16Z Dust Cover

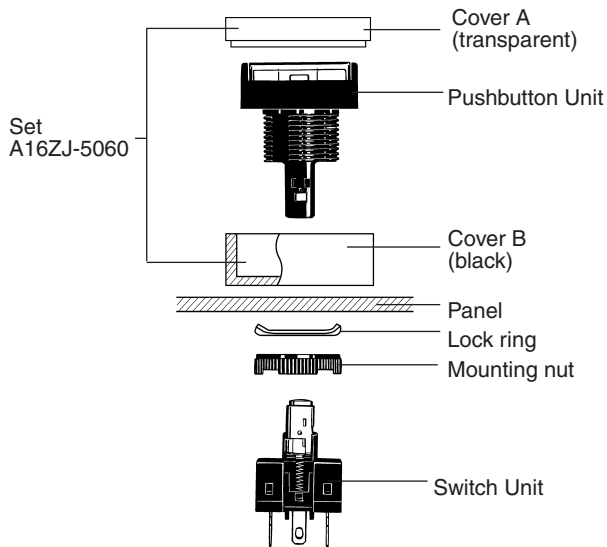

1. Separate the Dust Cover into 2 parts: cover A and cover B.
2. Insert the Case into cover B.
3. Mount these parts together onto the panel.
4. From the back of the panel, mount the lock ring and secure with the mounting nut.
5. Insert cover A into cover B. Ensure that the entire perimeter of cover A is securely attached to cover B by pressing in different directions.
6. Mount the Switch Unit to the Case.

Note: Recommended panel thickness: 0.5 to 2 mm.

■ Mounting the A16Z Switch Guard

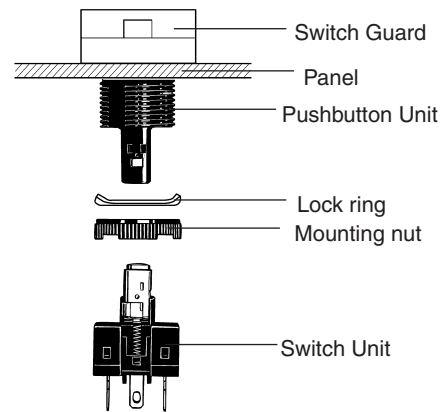

1. Insert the Case into the Switch Guard.
2. Mount these parts together onto the panel.
3. From the back of the panel, mount the lock ring and secure with the mounting nut.
4. Attach the Switch Unit to the Case.

Note: Recommended panel thickness: 0.5 to 2 mm.

Precautions

Refer to the *Technical Information for Pushbutton Switches* (Cat. No. A143).

⚠ WARNING

Do not apply a voltage between the incandescent lamp and the terminal that is greater than the rated voltage. If the incandescent lamp is broken, the operating part may pop out.

Always turn OFF the power and wait for 10 minutes before replacing the incandescent lamp. If the lamp is replaced immediately after the power is turned OFF, the remaining heat may cause burns.

Correct Use

Mounting

Always make sure that the power is turned OFF before mounting, removing, or wiring the Switch, or performing maintenance.

Do not tighten the mounting nut more than necessary using tools such as pointed-nose pliers. Doing so will damage the mounting nut. The tightening torque is 0.29 to 0.49 N·m.

Wiring

Solder Terminal

Solder terminals and quick-connect terminals (#110) are commonly used for terminals.

Be sure to use electrical wires that are a size appropriate for the applied voltage and carry current (conductor size is 0.5 to 0.75 mm²). Perform soldering according to the conditions provided below. If the soldering is not properly performed, the lead wires will become detached, resulting in short-circuits.

1. Hand soldering: 30 W, within 5 s
2. Dip soldering: 240°C, within 3 s

Wait for one minute after soldering before exerting any external force on the solder.

Use non-corrosive resin fluid as the flux.

Make sure that the electric cord is wired so that it does not touch the Unit. If the electric cord touches the Unit, then electric wires with a heat resistance of 100°C min. must be used.

After wiring the Switch, maintain an appropriate clearance and creepage distance.

Screw-Less Clamps

Mounting Procedure

1. Strip a length of 10 mm off the end of the wire (allowable range: 10±1 mm).
2. Bunch wire strands together and straighten them.
3. Insert the wire into the insertion hole while pressing the release button at the side of the hole. (Using a precision screwdriver is recommended.)
4. Let go of the release button to lock the wire into place.
5. After locking, pull on the wire gently to confirm that it is securely locked.

Removing Procedure

Remove wires by pulling them while pressing the release button.

Note: When reusing wires that have already been locked, cut off the end of the wire and strip the wire again before using.

Operating Environment

The IP65 model is designed with a degree of protection so that it will not sustain damage if it is subjected to water from any direction to the front of the panel.

Using the Microload

Insert a contact protection circuit, if necessary, to prevent the reduction of life expectancy due to extreme wear on the contacts caused by loads where inrush current occurs when the contact is opened and closed.

The A16 allows both a standard load (125 V at 5A, 250 V at 3 A) and a microload. If a standard load is applied, however, the microload area cannot be used. If the microload area is used with a standard load, the contact surface will become rough, and the opening and closing of the contact for a microload may become unreliable.

The minimum applicable load is the N-level reference value. This value indicates the malfunction reference level for the reliability level of 60% (λ 60) (conforming to JIS C5003).

The equation, λ 60 = 0.5×10^{-4} /operations indicates that the estimated malfunction rate is less than 1/2,000,000 operations with a reliability level of 60%.

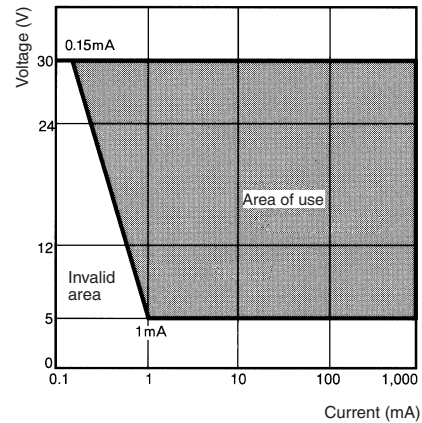

LED

The LED current-limiting resistor is built-in, so internal resistance is not required.

Rated voltage	Internal limiting resistor
5 VDC	33 Ω (82 Ω)
12 VDC	270 Ω (470 Ω)
24 VDC	1600 Ω (2400 Ω)

Note: The values in parentheses are for models with blue Pushbutton Units.

Others

The oil-resistant IP65 uses NBR rubber and is resistant to general cutting oil and cooling oil. Some particular oils cannot be used with the oil-resistant IP65, however, so contact your OMRON representative for details.

Pushbutton Switches

If the panel is to be finished with coating, etc., make sure that the panel meets the specified dimensions after the coating.

Do not subject the Switch to extreme shock or vibration. Doing so will cause malfunctions and damage to the Switch.

Do not let sharp objects come into contact with the Switches that are made of resin. Doing so will damage the Switches, causing scratches on the outside of the operating parts, and malfunction.

When handling the Switches, do not throw or drop them.

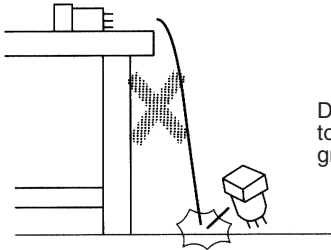

Do not allow the Switch to drop and hit the ground.

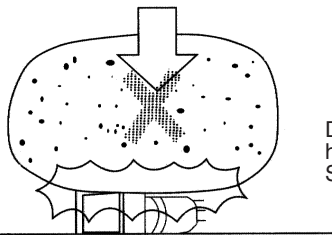

Do not place or drop heavy objects on the Switch.

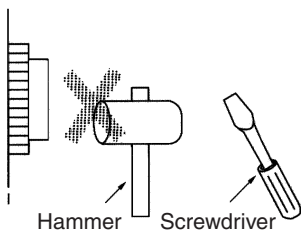

Do not operate the Switch with hard or sharp objects.

ALL DIMENSIONS SHOWN ARE IN MILLIMETERS.

To convert millimeters into inches, multiply by 0.03937. To convert grams into ounces, multiply by 0.03527.

Компания «Life Electronics» занимается поставками электронных компонентов импортного и отечественного производства от производителей и со складов крупных дистрибьюторов Европы, Америки и Азии.

С конца 2013 года компания активно расширяет линейку поставок компонентов по направлению коаксиальный кабель, кварцевые генераторы и конденсаторы (керамические, пленочные, электролитические), за счёт заключения дистрибьюторских договоров

Мы предлагаем:

- Конкурентоспособные цены и скидки постоянным клиентам.
- Специальные условия для постоянных клиентов.
- Подбор аналогов.
- Поставку компонентов в любых объемах, удовлетворяющих вашим потребностям.
- Приемлемые сроки поставки, возможна ускоренная поставка.
- Доставку товара в любую точку России и стран СНГ.
- Комплексную поставку.
- Работу по проектам и поставку образцов.
- Формирование склада под заказчика.
- Сертификаты соответствия на поставляемую продукцию (по желанию клиента).
- Тестирование поставляемой продукции.
- Поставку компонентов, требующих военную и космическую приемку.
- Входной контроль качества.
- Наличие сертификата ISO.

В составе нашей компании организован Конструкторский отдел, призванный помогать разработчикам, и инженерам.

Конструкторский отдел помогает осуществить:

- Регистрацию проекта у производителя компонентов.
- Техническую поддержку проекта.
- Защиту от снятия компонента с производства.
- Оценку стоимости проекта по компонентам.
- Изготовление тестовой платы монтаж и пусконаладочные работы.



Тел: +7 (812) 336 43 04 (многоканальный)

Email: org@lifeelectronics.ru