

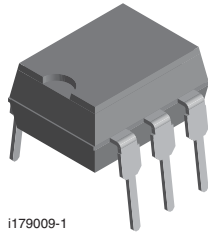

Optocoupler, Phototransistor Output, no Base Connection

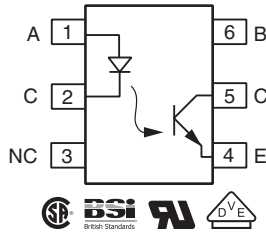

i179009-1



FEATURES

- Isolation test voltage, 5300 V_{RMS}
- No base terminal connection for improved common mode interface immunity
- Long term stability
- Industry standard dual in line package
- Compliant to RoHS Directive 2002/95/EC and in accordance to WEEE 2002/96/EC



RoHS COMPLIANT

DESCRIPTION

The MOC8101, MOC8102, MOC8103, MOC8104, MOC8105 family optocoupler consisting of a gallium arsenide infrared emitting diode optically coupled to a silicon planar phototransistor detector in a plastic plug-in DIP-6 package.

The coupling device is suitable for signal transmission between two electrically separated circuits. The potential difference between the circuits to be coupled should not exceed the maximum permissible reference voltages.

The base terminal of the MOC8101, MOC8102, MOC8103, MOC8104, MOC8105 is not connected, resulting in a substantially improved common mode interference immunity.

AGENCY APPROVALS

- UL1577, file no. E52744 system code H or J, double protection
- CSA 93751
- BSI IEC 60950; IEC 60065
- DIN EN 60747-5-5 (VDE 0884) available with option 1

ORDERING INFORMATION														
M	O	C	8	1	0	#	-	#	X	0	#	#	T	
PART NUMBER							CTR BIN		PACKAGE OPTION			TAPE AND REEL		
AGENCY CERTIFIED/PACKAGE		CTR (%)												
		10 mA												
UL, CSA, BSI		50 to 80	73 to 117	108 to 173	160 to 256	65 to 133								
DIP-6		MOC8101	MOC8102	MOC8103	MOC8104	MOC8105								
DIP-6, 400 mil, option 6		-	MOC8102-X006	-	-	-								
SMD-6, option 9		MOC8101-X009	MOC8102-X009	-	-	-								
VDE, UL, CSA, BSI		50 to 80	73 to 117	108 to 173	160 to 256	65 to 133								
DIP-6		MOC8101-X001	-	MOC8103-X001	-	-								
DIP-6, 400 mil		-	MOC8102-X016	-	MOC8104-X016	-								
SMD-6, option 7		MOC8101-X017T	MOC8102-X017T	-	-	-								
SMD-6, option 9		-	-	-	MOC8104-X019T	-								

Note

- Additional options may be possible, please contact sales office.



ABSOLUTE MAXIMUM RATINGS (T _{amb} = 25 °C, unless otherwise specified)				
PARAMETER	TEST CONDITION	SYMBOL	VALUE	UNIT
INPUT				
Reverse voltage		V _R	6.0	V
Forward continuous current		I _F	60	mA
Surge forward current	t ≤ 10 μs	I _{FSM}	2.5	A
Power dissipation		P _{diss}	100	mW
Derate linearly from 25°C			1.33	mW/°C
OUTPUT				
Collector emitter breakdown voltage		BV _{CEO}	30	V
Emitter collector breakdown voltage		BV _{ECO}	7.0	V
Collector current		I _C	50	mA
Derate linearly from 25°C			2.0	mW/°C
Power dissipation		P _{diss}	150	mW
COUPLER				
Isolation test voltage		V _{ISO}	5300	V _{RMS}
Creepage distance			≥ 7.0	mm
			8.0 ⁽²⁾	mm
Clearance distance			≥ 7.0	mm
			8.0 ⁽²⁾	mm
Isolation thickness between emitter and detector			≥ 0.4	mm
Comparative tracking index per DIN IEC 112/VDE 0303, part 1		CTI	175	
Isolation resistance	V _{IO} = 500 V	R _{IO}	10 ¹²	Ω
Derate linearly from 25 °C			3.33	mW/°C
Total power dissipation		P _{tot}	250	mW
Storage temperature		T _{stg}	- 55 to + 150	°C
Operating temperature		T _{amb}	- 55 to + 100	°C
Junction temperature		T _j	100	°C
Soldering temperature ⁽¹⁾	max. 10 s, dip soldering; distance to seating plane ≥ 1.5 mm	T _{slid}	260	°C

Notes

- Stresses in excess of the absolute maximum ratings can cause permanent damage to the device. Functional operation of the device is not implied at these or any other conditions in excess of those given in the operational sections of this document. Exposure to absolute maximum ratings for extended periods of the time can adversely affect reliability.
- (1) Refer to reflow profile for soldering conditions for surface mounted devices (SMD). Refer to wave profile for soldering conditions for through hole devices (DIP).
- (2) Applies to wide bending option 6.

ELECTRICAL CHARACTERISTICS (T _{amb} = 25 °C, unless otherwise specified)							
PARAMETER	TEST CONDITION	PART	SYMBOL	MIN.	TYP.	MAX.	UNIT
INPUT							
Forward voltage	I _F = 10 mA		V _F		1.25	1.5	V
Breakdown voltage	I _R = 10 μA		V _{BR}	6.0			V
Reverse current	V _R = 6.0 V		I _R		0.01	10	μA
Capacitance	V _R = 0 V, f = 1.0 MHz		C _O		25		pF
Thermal resistance			R _{thja}		750		K/W
OUTPUT							
Collector emitter capacitance	V _{CE} = 5.0 V, f = 1.0 MHz		C _{CE}		5.2		pF
Collector emitter dark current	V _{CE} = 10 V, T _{amp} = 25 °C	MOC8101	I _{CEO1}		1.0	50	nA
	V _{CE} = 10 V, T _{amp} = 100 °C	MOC8102	I _{CEO1}		1.0		μA
Collector emitter breakdown voltage	I _C = 1.0 mA		BV _{CEO}	30			V
Emitter collector breakdown voltage	I _E = 100 μA		BV _{ECO}	7.0			V
Thermal resistance			R _{thja}		500		K/W
COUPLER							
Saturation voltage collector emitter	I _F = 5.0 mA		V _{CEsat}		0.25	0.4	V
Coupling capacitance			C _C		0.6		pF

Note

- Minimum and maximum values are testing requirements. Typical values are characteristics of the device and are the result of engineering evaluation. Typical values are for information only and are not part of the testing requirements.



CURRENT TRANSFER RATIO ($T_{amb} = 25\text{ }^{\circ}\text{C}$, unless otherwise specified)							
PARAMETER	TEST CONDITION	PART	SYMBOL	MIN.	TYP.	MAX.	UNIT
Current transfer ratio	$V_{CE} = 10\text{ V}$, $I_F = 10\text{ mA}$	MOC8101	CTR	50		80	%
		MOC8102	CTR	73		117	%
		MOC8103	CTR	108		173	%
		MOC8104	CTR	160		256	%
		MOC8105	CTR	65		133	%

SWITCHING CHARACTERISTICS ($T_{amb} = 25\text{ }^{\circ}\text{C}$, unless otherwise specified)							
PARAMETER	TEST CONDITION	SYMBOL	MIN.	TYP.	MAX.	UNIT	
Turn-on time	$V_{CC} = 10\text{ V}$, $I_C = 2.0\text{ mA}$, $R_L = 100\text{ }\Omega$	t_{on}		3.0		μs	
Turn-off time	$V_{CC} = 10\text{ V}$, $I_C = 2.0\text{ mA}$, $R_L = 100\text{ }\Omega$	t_{off}		2.3		μs	
Rise time	$V_{CC} = 10\text{ V}$, $I_C = 2.0\text{ mA}$, $R_L = 100\text{ }\Omega$	t_r		2.0		μs	
Fall time	$V_{CC} = 10\text{ V}$, $I_C = 2.0\text{ mA}$, $R_L = 100\text{ }\Omega$	t_f		2.0		μs	
Cut off frequency		f_{co}		250		kHz	

TYPICAL CHARACTERISTICS ($T_{amb} = 25\text{ }^{\circ}\text{C}$, unless otherwise specified)

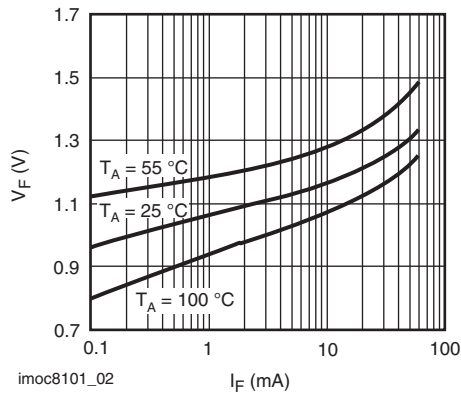

imoc8101_02

Fig. 1 - Forward Voltage vs. Forward Current

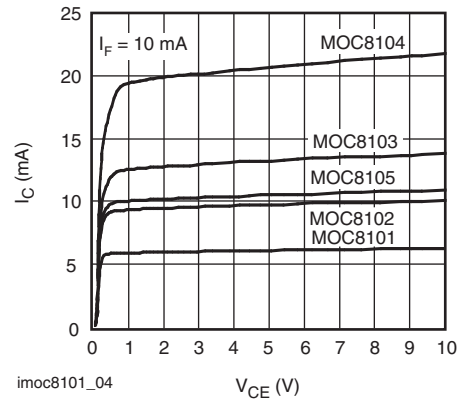

imoc8101_04

Fig. 3 - Collector Current vs. Collector Emitter Voltage

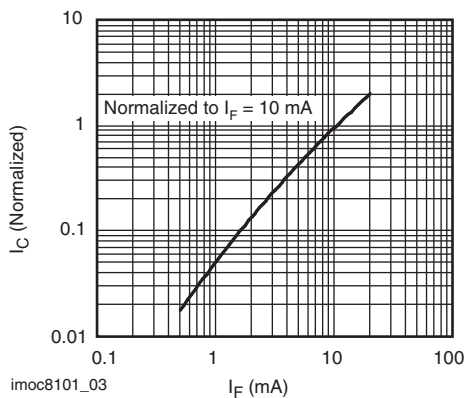

imoc8101_03

Fig. 2 - Collector Current vs. LED Forward Current

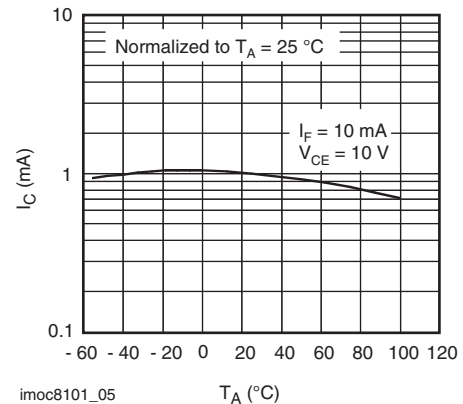

imoc8101_05

Fig. 4 - Collector Current vs. Ambient Temperature

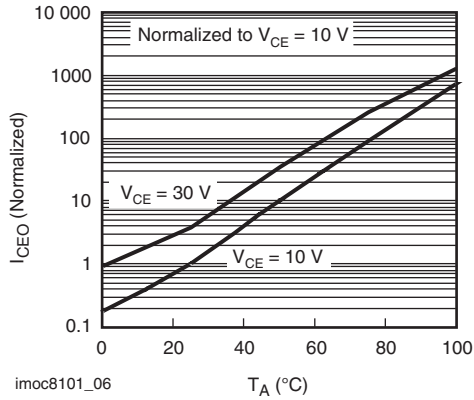

Fig. 5 - Collector Emitter Dark Current vs. Ambient Temperature

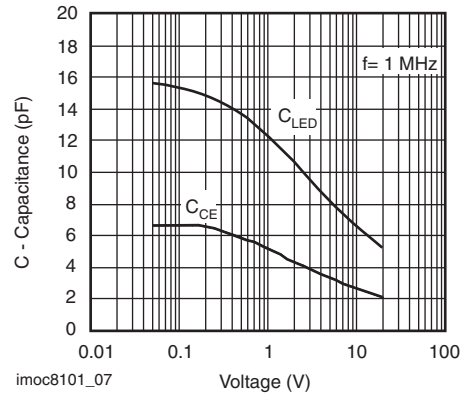
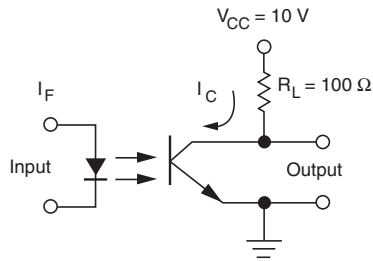
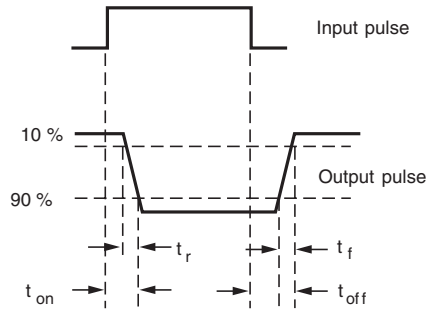

Fig. 6 - Capacitance vs. Voltage



Test circuit

imoc81010_01



Waveforms

Fig. 7 - Switching Time Test Circuit and Waveforms



DIP-6A

Package Dimensions in Inches (mm)

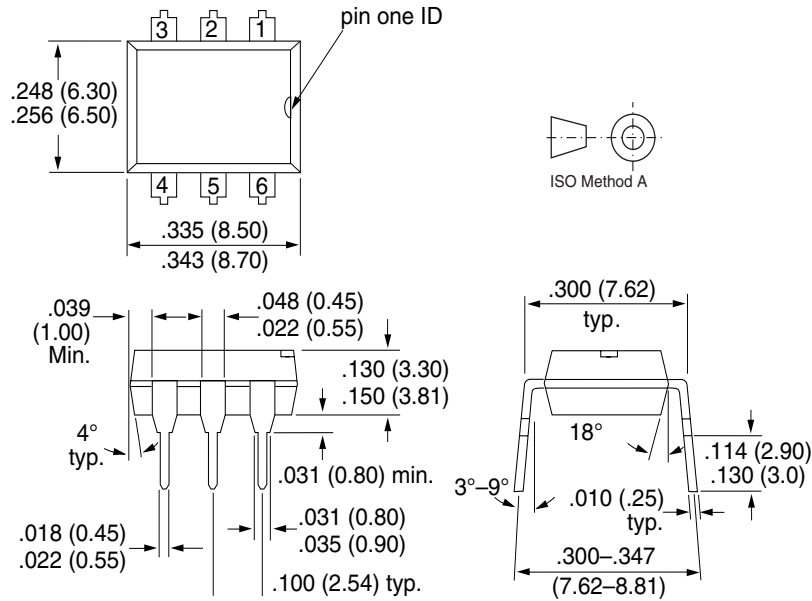

i178004

Ozone Depleting Substances Policy Statement

It is the policy of **Vishay Semiconductor GmbH** to

1. Meet all present and future national and international statutory requirements.
2. Regularly and continuously improve the performance of our products, processes, distribution and operating systems with respect to their impact on the health and safety of our employees and the public, as well as their impact on the environment.

It is particular concern to control or eliminate releases of those substances into the atmosphere which are known as ozone depleting substances (ODSs).

The Montreal Protocol (1987) and its London Amendments (1990) intend to severely restrict the use of ODSs and forbid their use within the next ten years. Various national and international initiatives are pressing for an earlier ban on these substances.

Vishay Semiconductor GmbH has been able to use its policy of continuous improvements to eliminate the use of ODSs listed in the following documents.

1. Annex A, B and list of transitional substances of the Montreal Protocol and the London Amendments respectively
2. Class I and II ozone depleting substances in the Clean Air Act Amendments of 1990 by the Environmental Protection Agency (EPA) in the USA
3. Council Decision 88/540/EEC and 91/690/EEC Annex A, B and C (transitional substances) respectively.

Vishay Semiconductor GmbH can certify that our semiconductors are not manufactured with ozone depleting substances and do not contain such substances.

**We reserve the right to make changes to improve technical design
and may do so without further notice.**

Parameters can vary in different applications. All operating parameters must be validated for each customer application by the customer. Should the buyer use Vishay Semiconductors products for any unintended or unauthorized application, the buyer shall indemnify Vishay Semiconductors against all claims, costs, damages, and expenses, arising out of, directly or indirectly, any claim of personal damage, injury or death associated with such unintended or unauthorized use.

Vishay Semiconductor GmbH, P.O.B. 3535, D-74025 Heilbronn, Germany
Telephone: 49 (0)7131 67 2831, Fax number: 49 (0)7131 67 2423



Disclaimer

ALL PRODUCT, PRODUCT SPECIFICATIONS AND DATA ARE SUBJECT TO CHANGE WITHOUT NOTICE TO IMPROVE RELIABILITY, FUNCTION OR DESIGN OR OTHERWISE.

Vishay Intertechnology, Inc., its affiliates, agents, and employees, and all persons acting on its or their behalf (collectively, "Vishay"), disclaim any and all liability for any errors, inaccuracies or incompleteness contained in any datasheet or in any other disclosure relating to any product.

Vishay makes no warranty, representation or guarantee regarding the suitability of the products for any particular purpose or the continuing production of any product. To the maximum extent permitted by applicable law, Vishay disclaims (i) any and all liability arising out of the application or use of any product, (ii) any and all liability, including without limitation special, consequential or incidental damages, and (iii) any and all implied warranties, including warranties of fitness for particular purpose, non-infringement and merchantability.

Statements regarding the suitability of products for certain types of applications are based on Vishay's knowledge of typical requirements that are often placed on Vishay products in generic applications. Such statements are not binding statements about the suitability of products for a particular application. It is the customer's responsibility to validate that a particular product with the properties described in the product specification is suitable for use in a particular application. Parameters provided in datasheets and/or specifications may vary in different applications and performance may vary over time. All operating parameters, including typical parameters, must be validated for each customer application by the customer's technical experts. Product specifications do not expand or otherwise modify Vishay's terms and conditions of purchase, including but not limited to the warranty expressed therein.

Except as expressly indicated in writing, Vishay products are not designed for use in medical, life-saving, or life-sustaining applications or for any other application in which the failure of the Vishay product could result in personal injury or death. Customers using or selling Vishay products not expressly indicated for use in such applications do so at their own risk. Please contact authorized Vishay personnel to obtain written terms and conditions regarding products designed for such applications.

No license, express or implied, by estoppel or otherwise, to any intellectual property rights is granted by this document or by any conduct of Vishay. Product names and markings noted herein may be trademarks of their respective owners.

Material Category Policy

Vishay Intertechnology, Inc. hereby certifies that all its products that are identified as RoHS-Compliant fulfill the definitions and restrictions defined under Directive 2011/65/EU of The European Parliament and of the Council of June 8, 2011 on the restriction of the use of certain hazardous substances in electrical and electronic equipment (EEE) - recast, unless otherwise specified as non-compliant.

Please note that some Vishay documentation may still make reference to RoHS Directive 2002/95/EC. We confirm that all the products identified as being compliant to Directive 2002/95/EC conform to Directive 2011/65/EU.

Vishay Intertechnology, Inc. hereby certifies that all its products that are identified as Halogen-Free follow Halogen-Free requirements as per JEDEC JS709A standards. Please note that some Vishay documentation may still make reference to the IEC 61249-2-21 definition. We confirm that all the products identified as being compliant to IEC 61249-2-21 conform to JEDEC JS709A standards.

Компания «Life Electronics» занимается поставками электронных компонентов импортного и отечественного производства от производителей и со складов крупных дистрибьюторов Европы, Америки и Азии.

С конца 2013 года компания активно расширяет линейку поставок компонентов по направлению коаксиальный кабель, кварцевые генераторы и конденсаторы (керамические, пленочные, электролитические), за счёт заключения дистрибьюторских договоров

Мы предлагаем:

- Конкурентоспособные цены и скидки постоянным клиентам.
- Специальные условия для постоянных клиентов.
- Подбор аналогов.
- Поставку компонентов в любых объемах, удовлетворяющих вашим потребностям.
- Приемлемые сроки поставки, возможна ускоренная поставка.
- Доставку товара в любую точку России и стран СНГ.
- Комплексную поставку.
- Работу по проектам и поставку образцов.
- Формирование склада под заказчика.
- Сертификаты соответствия на поставляемую продукцию (по желанию клиента).
- Тестирование поставляемой продукции.
- Поставку компонентов, требующих военную и космическую приемку.
- Входной контроль качества.
- Наличие сертификата ISO.

В составе нашей компании организован Конструкторский отдел, призванный помогать разработчикам, и инженерам.

Конструкторский отдел помогает осуществить:

- Регистрацию проекта у производителя компонентов.
- Техническую поддержку проекта.
- Защиту от снятия компонента с производства.
- Оценку стоимости проекта по компонентам.
- Изготовление тестовой платы монтаж и пусконаладочные работы.



Тел: +7 (812) 336 43 04 (многоканальный)

Email: org@lifeelectronics.ru