

7 6 5 4 3 2 1

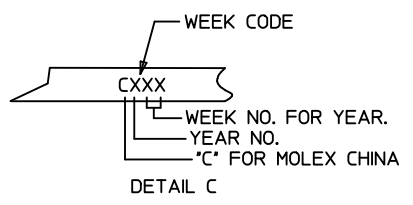
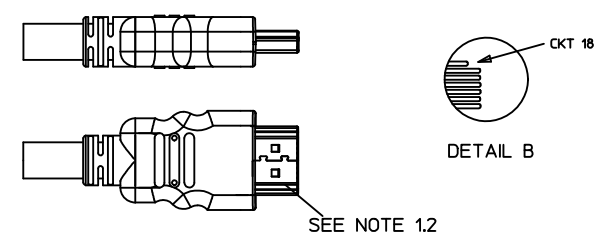
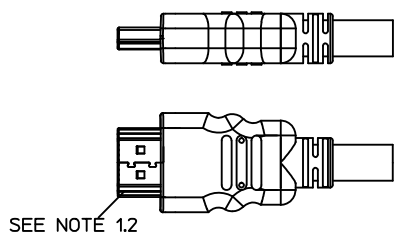
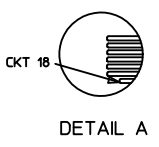
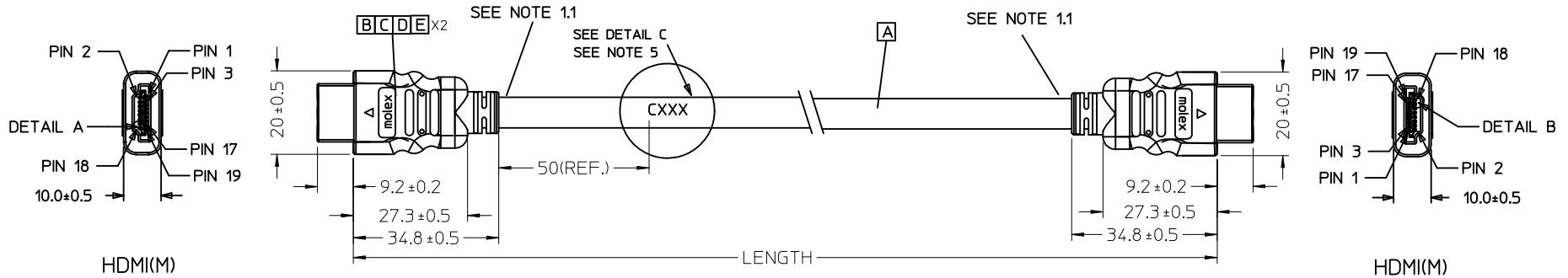

887689830	HDMI TO HDMI CABLE ASS'Y,5M	5000 ± 100	BLACK	7.3MM(TMDS - AWG#28)	172005984
887689820	HDMI TO HDMI CABLE ASS'Y,3M	3000 ± 80	BLACK	7.3MM(TMDS - AWG#28)	172005984
887689810	HDMI TO HDMI CABLE ASS'Y,2M	2000 ± 60	BLACK	7.3MM(TMDS - AWG#28)	172005984
887689800	HDMI TO HDMI CABLE ASS'Y,1M	1000 ± 30	BLACK	7.3MM(TMDS - AWG#28)	172005984
MX P/N	DESCRIPTION	LENGTH	CABLE COLOR	CABLE OD	CABLE P/N

ENTER DESCRIPTION EC NO: DG2011-0439 DRWN: FZHANG01 CHKD: JLU13 APPR: ZXDENG G	2011/05/04 2011/05/04 2011/05/11	DESCRIPTION REV	QUALITY SYMBOLS ▽=0 ◻=0	GENERAL TOLERANCES (UNLESS SPECIFIED) mm INCH 4 PLACES ± --- ± --- 3 PLACES ± --- ± --- 2 PLACES ± --- ± --- 1 PLACE ± --- ± --- ANGULAR ± ---°	DIMENSION STYLE MM ONLY DRAWN BY: FZHANG01 DATE: 2011/05/04 CHECKED BY: LPNING DATE: 2011/05/04 APPROVED BY: ZXDENG DATE: 2011/05/11	SCALE ---	DESIGN UNITS METRIC	THIRD ANGLE PROJECTION		
			DRAFT WHERE APPLICABLE MUST REMAIN WITHIN DIMENSIONS				MATERIAL NO. SEE TABLE	TITLE HDMI(M) TO HDMI(M) CABLE ASS'Y		
							MOLEX INCORPORATED	SHEET NO. 1 OF 2		
							DOCUMENT NO. SD-88768-9800			
							THIS DRAWING CONTAINS INFORMATION THAT IS PROPRIETARY TO MOLEX INCORPORATED AND SHOULD NOT BE USED WITHOUT WRITTEN PERMISSION			

6 5 4 3 2 1

NOTE:

1. OVERMOLD SPECIFICATION:
 - 1.1 HDMI OUTER MOLDED WITH PVC RESIN
HDMI INNER MOLDED WITH PVC RESIN
 - 1.2 DUST COVER MOLDED WITH PE
2. PRODUCT ELECTRICAL SPECIFICATION REFER TO HDMI SPEC.
3. THE CODE PLEASE BE PRINTED ON THE SPACE
4. THIS PRODUCT MUST MEET EU CHEMICAL SUBSTANCE SPECIFICATION FOR PRODUCTS. (EU 2002/95/EC)

WIRE DIAGRAM:

SHIELD	SHIELD	OVERALL SHIELD	GROUND
PIN 19	PIN 19	PINK	HOT PLUG DETECT
PIN 18	PIN 18	ORANGE	+5V POWER
PIN 17	PIN 17	YELLOW	DDC/CEC GROUND
PIN 16	PIN 16	WHITE	SDA
PIN 15	PIN 15	RED	SCL
PIN 14	PIN 14	VIOLET	RESERVED
PIN 13	PIN 13	GRAY	CEC
PIN 12	PIN 12	WHITE	TMDS CLOCK-
PIN 11	PIN 11	BRAID	TMDS CLOCK SHIELD
PIN 10	PIN 10	BLACK	TMDS CLOCK+
PIN 9	PIN 9	WHITE	TMDS DATA 0-
PIN 8	PIN 8	BRAID	TMDS DATA 0 SHIELD
PIN 7	PIN 7	BLUE	TMDS DATA 0+
PIN 6	PIN 6	WHITE	TMDS DATA 1-
PIN 5	PIN 5	BRAID	TMDS DATA 1 SHIELD
PIN 4	PIN 4	GREEN	TMDS DATA 1+
PIN 3	PIN 3	WHITE	TMDS DATA 2-
PIN 2	PIN 2	BRAID	TMDS DATA 2 SHIELD
PIN 1	PIN 1	RED	TMDS DATA 2+
HDMI	HDMI	COLOR	CABLE FUNCTION

E	PRE-CUT C.Foil 47X23mm T=25U		2
D	COPPER FOIL		2
C	HDMI 19P MALE,30U"Au Solder Type		2
B	Metal Shell For HDMI 19P Male		2
A	(4P+1P)X28+5CX28,ALSH,PVC,BK,7.3,UL20276 (SEE TABLE)		1
ITEM	DESCRIPTION	L	QTY.

ENTER DESCRIPTION EC NO: DG2011-0439 DRWN:FZHANG01 CHKD:JLU13 APPR:ZXDENG	DESCRIPTION REV	QUALITY SYMBOLS	GENERAL TOLERANCES (UNLESS SPECIFIED)	DIMENSION STYLE	SCALE	DESIGN UNITS	THIRD ANGLE PROJECTION
		▼=0 ▽=0	mm INCH	MM ONLY	---	METRIC	
		4 PLACES ± --- ± ---	DRAWN BY DATE	TITLE			
		3 PLACES ± --- ± ---	FZHANG01 2011/05/04	HDMI(M) TO HDMI(M) CABLE ASS'Y			
		2 PLACES ± --- ± ---	CHECKED BY DATE				
1 PLACE ± --- ± ---	LPNING 2011/05/04						
ANGULAR ± ---°		APPROVED BY DATE	MOLEX INCORPORATED				
DRAFT WHERE APPLICABLE MUST REMAIN WITHIN DIMENSIONS		ZXDENG 2011/05/11	MATERIAL NO.	DOCUMENT NO.	SHEET NO.		
		SEE TABLE	SD-88768-9800		2 OF 2		
		SIZE A 4	THIS DRAWING CONTAINS INFORMATION THAT IS PROPRIETARY TO MOLEX INCORPORATED AND SHOULD NOT BE USED WITHOUT WRITTEN PERMISSION				

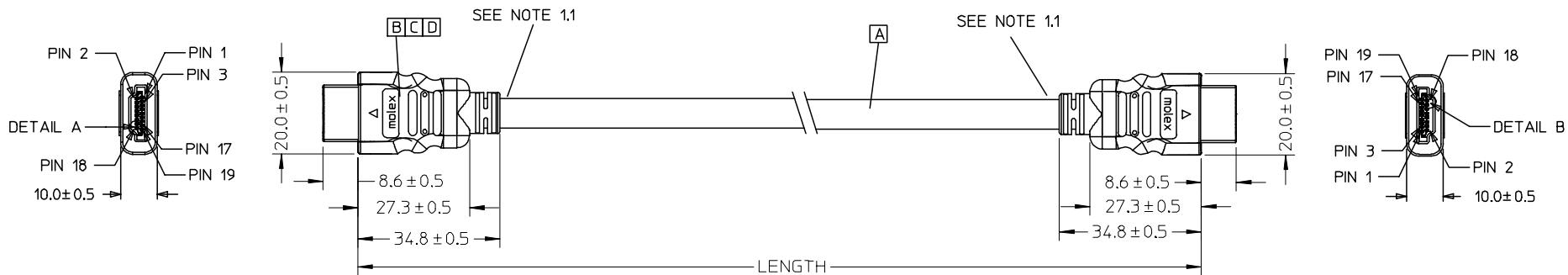

HDMI(M)

HDMI(M)

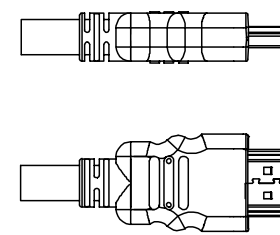
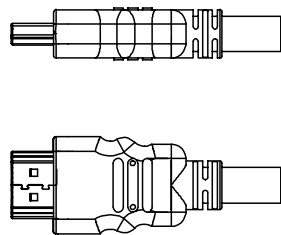
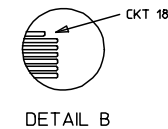
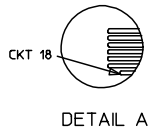

88768-9830	HDMI TO HDMI CABLE ASS'Y,5M	5000 ± 100	BLACK	7.3MM(TMDS - AWG#28)	887808610
88768-9820	HDMI TO HDMI CABLE ASS'Y,3M	3000 ± 80	BLACK	7.3MM(TMDS - AWG#28)	887808610
88768-9810	HDMI TO HDMI CABLE ASS'Y,2M	2000 ± 60	BLACK	7.3MM(TMDS - AWG#28)	887808610
88768-9800	HDMI TO HDMI CABLE ASS'Y,1M	1000 ± 30	BLACK	7.3MM(TMDS - AWG#28)	887808610
MX P/N	DESCRIPTION	LENGTH	CABLE COLOR	CABLE OD	CABLE P/N

ENTER DESCRIPTION EC NO: DG2006-0144 TDRWN: JFZHENG 2005/12/27 CHKD: 2005/12/30 APPR: DQLUO 2006/01/16	QUALITY SYMBOLS =0 =0	GENERAL TOLERANCES (UNLESS SPECIFIED)		DIMENSION STYLE MM ONLY		SCALE ---	DESIGN UNITS METRIC	THIRD ANGLE PROJECTION	
			mm	INCH	DRAWN BY JFZHENG	DATE 2005/12/26	TITLE AWG28 HDMI TO HDMI CABLE ASS'Y		
		4 PLACES	± ---	± ---	CHECKED BY JFZHENG	DATE 2005/12/26			
		3 PLACES	± ---	± ---	APPROVED BY DQLUO	DATE 2005/12/26	MOLEX INCORPORATED		
2 PLACES	± ---	± ---	DRAFT WHERE APPLICABLE MUST REMAIN WITHIN DIMENSIONS		MATERIAL NO. ENTER PART	DOCUMENT NO. SD-887689800	SHEET NO. 1 OF 00		
1 PLACE	± ---	± ---			SIZE A 4	THIS DRAWING CONTAINS INFORMATION THAT IS PROPRIETARY TO MOLEX INCORPORATED AND SHOULD NOT BE USED WITHOUT WRITTEN PERMISSION			
ANGULAR ± ---°									

NOTE:

1. OVMOLD SPECIFICATION:

- 1.1 HDMI INNERMOLD WITH BK PVC 887800019.
- 1.2 HDMI OVERMOLD WITH PVC 887800150.

2. MECHANICAL SPECIFICATION:

CABLE SHOULD STAND THE PULL FORCE 89-111N FOR 30 SECONDS WITH NO VISIBLE TERMINATION DAMAGE.

3. PRODUCT ELECTRICAL SPECIFICATION:

- 3.1 DIELECTRIC STRENGTH.
- 3.2 INSULATION RESISTANCE
- 3.3 CONDUCTIVE RESISTANCE.
- 3.4 TMDS Signals Time Domain Impedence
- 3.5 TMDS Signals Time Domain Crosstalk:FEXT
- 3.6 TMDS Signals Skew
- 3.7 Attenuation(

REFER TO ES-002 ELECTRICAL SPECIFICATION FOR DETAILS.

4.CABLE CONSTRUCTION



(AWG#28*1P+D)*4 + AWG#28*1P + AWG#28*5C, 7.3MMOD

5. THIS PRODUCT MUST MEET ROHS COMPLIANCE.

WIRE DIAGRAM:

SHIELD	SHIELD	OVERALL SHIELD	GROUND
PIN 19	PIN 19	PINK	HOT PLUG DETECT
PIN 18	PIN 18	ORANGE	+5V POWER
PIN 17	PIN 17	YELLOW	DDC/CEC GROUND
PIN 16	PIN 16	WHITE	SDA
PIN 15	PIN 15	RED	SCL
PIN 14	PIN 14	VIOLET	RESERVED
PIN 13	PIN 13	GRAY	CEC
PIN 12	PIN 12	WHITE	TMDS CLOCK-
PIN 11	PIN 11	BRAID	TMDS CLOCK SHIELD
PIN 10	PIN 10	WHITE/BLACK	TMDS CLOCK+
PIN 9	PIN 9	WHITE	TMDS DATA 0-
PIN 8	PIN 8	BRAID	TMDS DATA 0 SHIELD
PIN 7	PIN 7	WHITE/BLUE	TMDS DATA 0+
PIN 6	PIN 6	WHITE	TMDS DATA 1-
PIN 5	PIN 5	BRAID	TMDS DATA 1 SHIELD
PIN 4	PIN 4	WHITE/GREEN	TMDS DATA 1+
PIN 3	PIN 3	WHITE	TMDS DATA 2-
PIN 2	PIN 2	BRAID	TMDS DATA 2 SHIELD
PIN 1	PIN 1	WHITE/RED	TMDS DATA 2+
HDMI	HDMI	COLOR	CABLE FUNCTION

D	SMALL METAL PLATE 47152-6009		2
C	HDMI METAL CAN 47152-4001		2
B	HDMI HOUSING ASSY' 47152-1100		2
A	HDMI SINGLE LINK CABLE (SEE TABLE)		1
ITEM	DESCRIPTION	L	QTY.

ENTER DESCRIPTION EC NO: DG2006-0144 TDRWN: JFZHENG 2005/12/27 CHKD: 2005/12/30 APPR: DQLUO 2006/01/16	QUALITY SYMBOLS  = 0  = 0	GENERAL TOLERANCES (UNLESS SPECIFIED)		DIMENSION STYLE		SCALE	DESIGN UNITS	THIRD ANGLE PROJECTION		
				MM ONLY		---	METRIC			
		4 PLACES	±---	±---	DRAWN BY	DATE	TITLE AWG28 HDMI TO HDMI CABLE ASS'Y			
		3 PLACES	±---	±---	JFZHENG	2005/12/26				
2 PLACES	±---	±---	CHECKED BY	DATE	MATERIAL NO. DOCUMENT NO. SHEET NO. ENTER PART SD-887689800 2 OF 00					
1 PLACE	±---	±---	JFZHENG	2005/12/26						
ANGULAR ±---°		APPROVED BY		DATE	THIS DRAWING CONTAINS INFORMATION THAT IS PROPRIETARY TO MOLEX INCORPORATED AND SHOULD NOT BE USED WITHOUT WRITTEN PERMISSION					
		DQLUO		2005/12/26						
DRAFT WHERE APPLICABLE MUST REMAIN WITHIN DIMENSIONS		SIZE								
		A/4								

Компания «Life Electronics» занимается поставками электронных компонентов импортного и отечественного производства от производителей и со складов крупных дистрибьюторов Европы, Америки и Азии.

С конца 2013 года компания активно расширяет линейку поставок компонентов по направлению коаксиальный кабель, кварцевые генераторы и конденсаторы (керамические, пленочные, электролитические), за счёт заключения дистрибьюторских договоров

Мы предлагаем:

- Конкурентоспособные цены и скидки постоянным клиентам.
- Специальные условия для постоянных клиентов.
- Подбор аналогов.
- Поставку компонентов в любых объемах, удовлетворяющих вашим потребностям.
- Приемлемые сроки поставки, возможна ускоренная поставка.
- Доставку товара в любую точку России и стран СНГ.
- Комплексную поставку.
- Работу по проектам и поставку образцов.
- Формирование склада под заказчика.
- Сертификаты соответствия на поставляемую продукцию (по желанию клиента).
- Тестирование поставляемой продукции.
- Поставку компонентов, требующих военную и космическую приемку.
- Входной контроль качества.
- Наличие сертификата ISO.

В составе нашей компании организован Конструкторский отдел, призванный помогать разработчикам, и инженерам.

Конструкторский отдел помогает осуществить:

- Регистрацию проекта у производителя компонентов.
- Техническую поддержку проекта.
- Защиту от снятия компонента с производства.
- Оценку стоимости проекта по компонентам.
- Изготовление тестовой платы монтаж и пусконаладочные работы.



Тел: +7 (812) 336 43 04 (многоканальный)
Email: org@lifeelectronics.ru