

# Distinctive Characteristics

Slide type and piano type actuators available.

Twin sliding contact mechanism with self-cleaning action (JS01) provides smooth actuation and produces high contact reliability.

Gold plated contacts prevent oxidation and sulfide effect and provide stable contact resistance.

Use of self-extinguishing UL94V-0 certified material in cover and base provides high arc resistance and high insulation resistance.

Slanted terminals ensure secure PCB mounting and prevent dislodging during wave soldering.

Terminal spacing conforms to standard .100" (2.54mm) PCB grid.

End-to-end stackable.

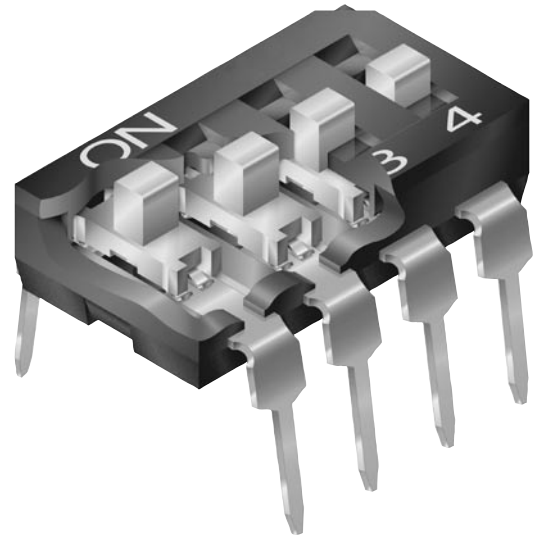

Actual Sizes

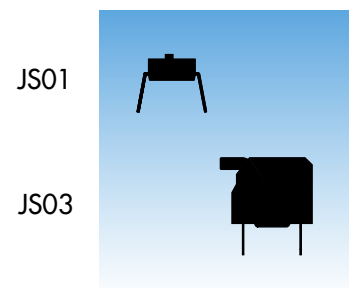

# General Specifications

## Electrical Capacity (Resistive Load)

**Switching Rating:** 25mA @ 24V DC  
**Nonswitching Rating:** 0.1A @ 50V DC

## Other Ratings

**Contact Resistance:** 50 milliohms maximum  
**Insulation Resistance:** 100 megohms minimum @ 500V DC  
**Dielectric Strength:** 500V AC minimum for 1 minute minimum  
**Mechanical Life:** 2,000 operations minimum  
**Electrical Life:** 2,000 operations minimum  
**Total Travel:** For slide actuator: .031" (0.8mm); for piano actuator: .114" (2.9mm)

## Materials & Finishes

	<b>JS01 Slide DIP</b>	<b>JS03 Piano DIP</b>
<b>Actuator:</b>	Glass fiber reinforced polyamide	Glass fiber reinforced PBT
<b>Cover:</b>	Glass fiber reinforced polyamide (UL94V-0)	Glass fiber reinforced PBT (UL94V-0)
<b>Base:</b>	Glass fiber reinforced polyamide (UL94V-0)	Glass fiber reinforced PBT (UL94V-0)
<b>Contacts:</b>	Beryllium copper with gold plating	Phosphor bronze with gold plating
<b>Terminals:</b>	Brass with gold plating	Phosphor bronze with gold plating

## Environmental Data

**Operating Temp Range:** -25°C through +70°C (-13°F through +158°F)  
**Humidity:** 90 ~ 95% humidity for 96 hours @ 40°C (104°F)  
**Vibration:** 10 ~ 55Hz with peak-to-peak amplitude of 1.5mm traversing the frequency range & returning in 1 minute; 3 right angled directions for 2 hours  
**Shock:** 50G (490m/s<sup>2</sup>) acceleration (tested in 6 right angled directions, with 5 shocks in each direction)

## PCB Processing

**Soldering:** Wave Soldering Recommended. See Profile A in Supplement section.  
 Manual Soldering: See Profile A in Supplement section.  
 Note: Switches are packaged in OFF position and should be soldered in OFF position.  
**Cleaning:** These devices are not process sealed. Hand clean locally using alcohol based solution.

## Standards & Certifications

**Flammability Standards:** UL 94V-0 rated cover & base  
**UL Recognition or CSA Certification:** The JS series devices have not been tested for UL recognition and CSA certification. These switches are designed for use in a low-voltage, low-current circuit. When used as intended in a low-voltage, low-current circuit, the results do not produce hazardous energy.

### TYPICAL SWITCH ORDERING EXAMPLE

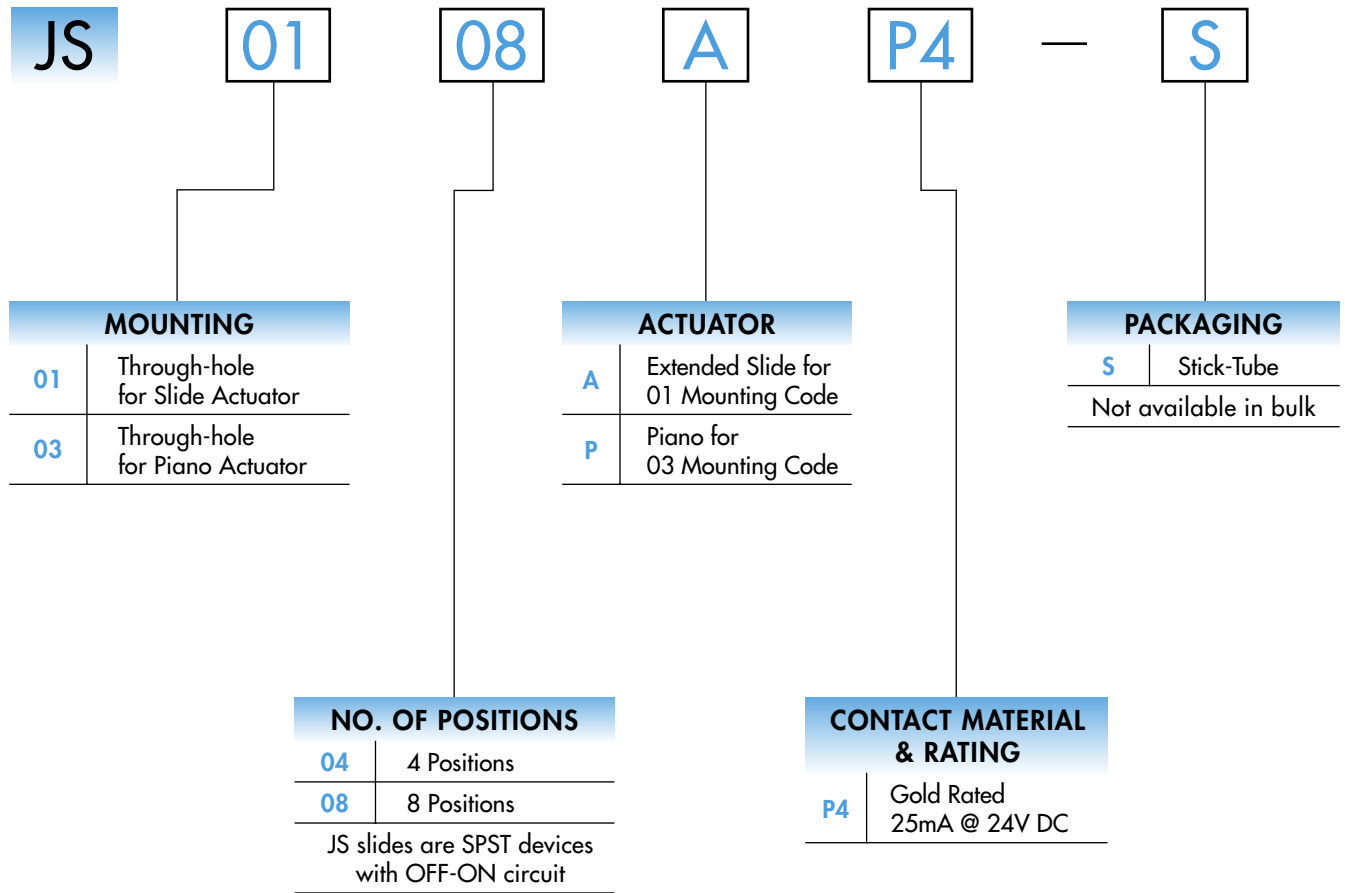

### DESCRIPTION FOR TYPICAL ORDERING EXAMPLE

**JS0108AP4-S**

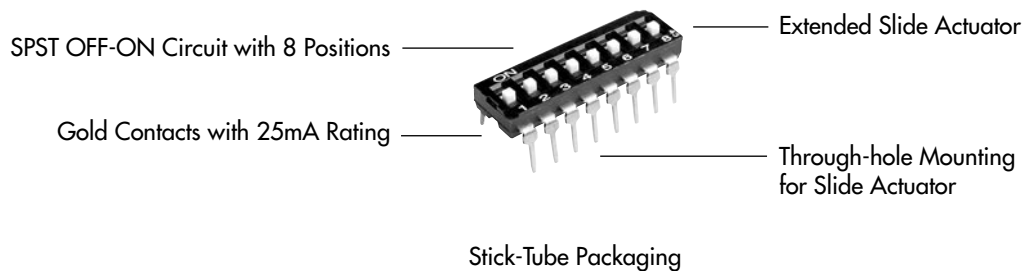

### TYPICAL SWITCH DIMENSIONS

#### 4 Positions

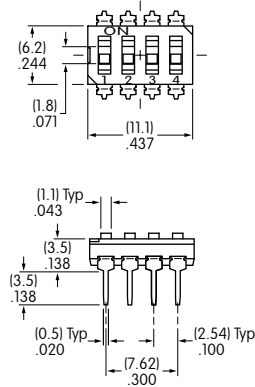

#### Slide Actuator

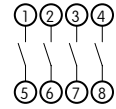
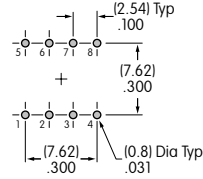
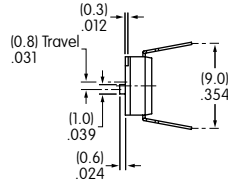

JS0104AP4

End View

Schematic

#### 8 Positions

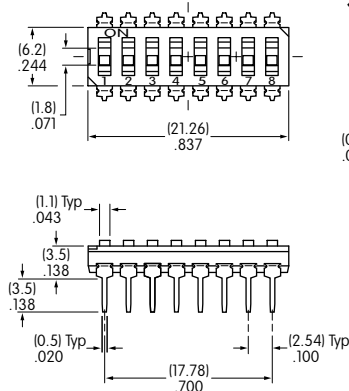
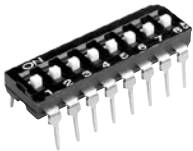

#### Slide Actuator

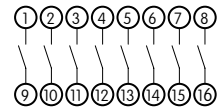
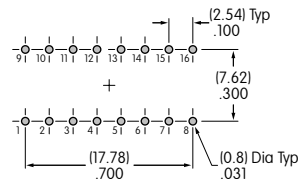
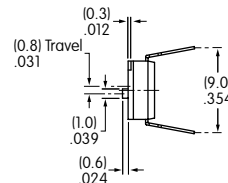

JS0108AP4

End View

Schematic

#### 4 Positions

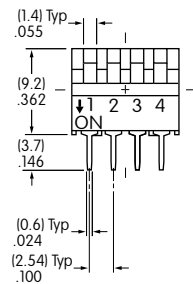

#### Piano Actuator

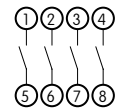
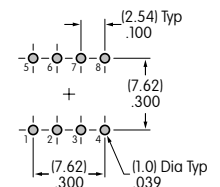
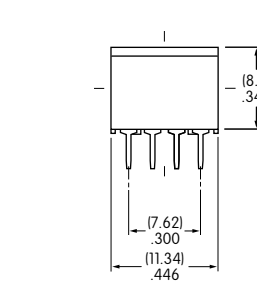
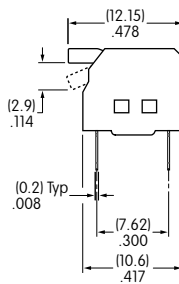

JS0304PP4

Schematic

#### 8 Positions

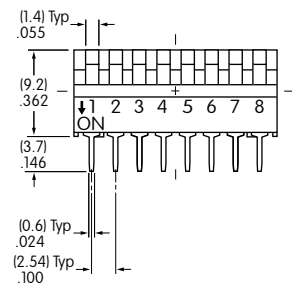
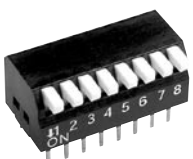

#### Piano Actuator

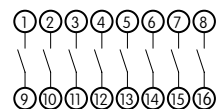
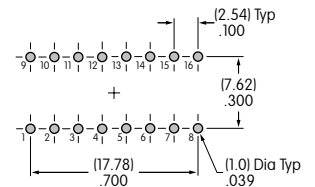
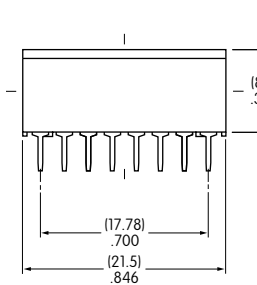
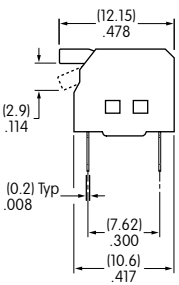

JS0308PP4

Schematic

## PACKAGING



### Stick-Tube Packaging

Switches are not available in bulk and must be ordered in increments of:

#### Slide Actuator

JS0104AP4-S: 46 pieces per stick-tube

JS0108AP4-S: 24 pieces per stick-tube

#### Piano Actuator

JS0304PP4-S: 44 pieces per stick-tube

JS0308PP4-S: 23 pieces per stick-tube

Switches are packaged in OFF position.

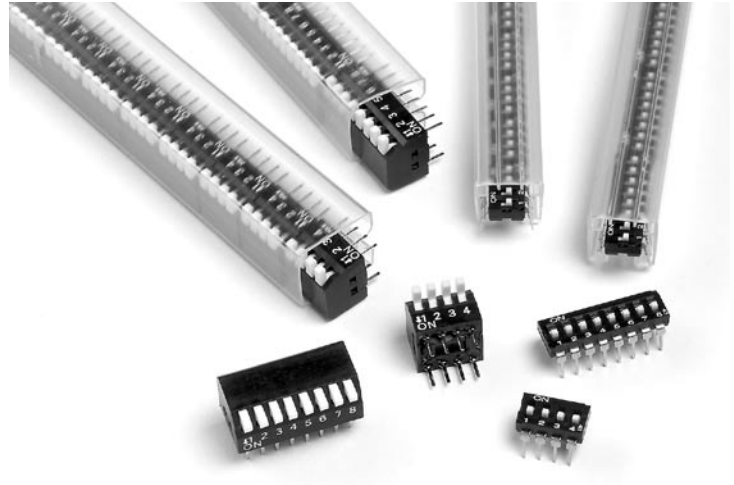

**Stick-Tube Dimensions for Slide Actuator  
JS0104AP4-S & JS0108AP4-S**

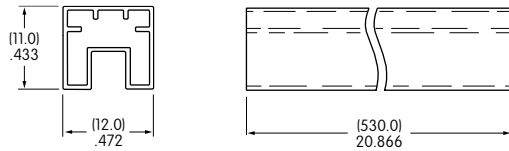

**Stick-Tube Dimensions for Piano Actuator  
JS0304PP4-S & JS0308PP4-S**

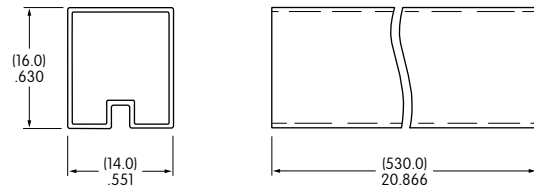

Компания «Life Electronics» занимается поставками электронных компонентов импортного и отечественного производства от производителей и со складов крупных дистрибьюторов Европы, Америки и Азии.

С конца 2013 года компания активно расширяет линейку поставок компонентов по направлению коаксиальный кабель, кварцевые генераторы и конденсаторы (керамические, пленочные, электролитические), за счёт заключения дистрибьюторских договоров

Мы предлагаем:

- Конкурентоспособные цены и скидки постоянным клиентам.
- Специальные условия для постоянных клиентов.
- Подбор аналогов.
- Поставку компонентов в любых объемах, удовлетворяющих вашим потребностям.
- Приемлемые сроки поставки, возможна ускоренная поставка.
- Доставку товара в любую точку России и стран СНГ.
- Комплексную поставку.
- Работу по проектам и поставку образцов.
- Формирование склада под заказчика.
- Сертификаты соответствия на поставляемую продукцию (по желанию клиента).
- Тестирование поставляемой продукции.
- Поставку компонентов, требующих военную и космическую приемку.
- Входной контроль качества.
- Наличие сертификата ISO.

В составе нашей компании организован Конструкторский отдел, призванный помогать разработчикам, и инженерам.

Конструкторский отдел помогает осуществить:

- Регистрацию проекта у производителя компонентов.
- Техническую поддержку проекта.
- Защиту от снятия компонента с производства.
- Оценку стоимости проекта по компонентам.
- Изготовление тестовой платы монтаж и пусконаладочные работы.



Тел: +7 (812) 336 43 04 (многоканальный)

Email: [org@lifeelectronics.ru](mailto:org@lifeelectronics.ru)