



Typical unit

**FEATURES**

- Settable output voltage range
  - MYMGK1R806FRSR: 0.7 to 1.8Vdc
  - MYMGK00506ERSR: 0.7 to 5.0Vdc
- Up to 6A of output current
- Quick response to load change
- Ultra small surface mount package  
9.0 x 7.5 x 5.0mm
- High efficiency of 97.5%
- Outstanding thermal derating performance
- Over current protection
- On/Off control (Positive logic)
- Power Good signal
- High Reliability / Heat Shock Testing  
700cycle (-40 to +125degC)
- Meets CISPR 22 class B conducted emission

**PRODUCT OVERVIEW**

The **MYMGK1R806FRSR/MYMGK00506ERSR** are miniature MonoBK™ called “Mono Block”, non-isolated Point-of-Load (PoL) DC-DC power converters for embedded applications. The small form factor measures only 9.0 x 7.5 x 5.0 mm. Applications include powering FPGA/CPU's, datacom/telecom systems, Distributed Bus Architectures (DBA), programmable logic and mixed voltage systems. The converters have input voltage ranges of 4.5 to 8.0Vdc (MYMGK1R806FRSR) or 8.0 to 15.0Vdc (MYMGK00506ERSR) and a maximum output current of 6A. Based on a fixed frequency synchronous buck converter switching topology, this high power conversion efficient PoL module features settable output voltage 0.7 to 1.8Vdc (MYMGK1R806FRSR) or 0.7 to 5.0Vdc (MYMGK00506ERSR), On/Off control and Power Good signal output. These converters also include under voltage lock out (UVLO), output short circuit protection and over-current protection.

**SIMPLIFIED APPLICATION**

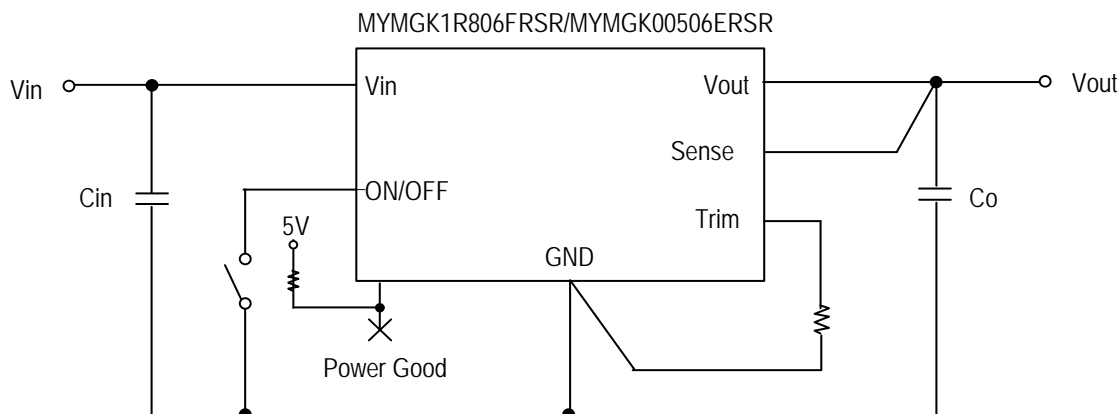

MYMGK1R806FRSR  
Cin: 47uF/10V x 2pcs  
Co: 220uF/4V x 2pcs

MYMGK00506ERSR  
Cin: 22uF/25V x 2pcs  
Co: 220uF/4V x 2pcs (at Vout=0.7-3.0V)  
100uF/6.3V x 4pcs (at Vout=3.0-5.0V)

(Typical topology is shown. Murata recommends an external input fuse.)

**PERFORMANCE SPECIFICATIONS SUMMARY AND ORDERING GUIDE (Including series products)**

| PART NUMBER     | OUTPUT              |               |           |                      |                  |         | INPUT          |             |                  |                   | Efficiency (%) | ON/OFF         | PACKAGE (mm)    |
|-----------------|---------------------|---------------|-----------|----------------------|------------------|---------|----------------|-------------|------------------|-------------------|----------------|----------------|-----------------|
|                 | Vout (Vdc)          | Iout (A,max.) | Power (W) | R/N typ. (% of Vout) | Regulation(max.) |         | Vin typ. (Vdc) | Range (Vdc) | Iin no load (mA) | Iin full load (A) |                |                |                 |
|                 |                     |               |           |                      | Line(%)          | Load(%) |                |             |                  |                   |                |                |                 |
| MYMGK1R806FRSR  | 0.7-1.8 (typ.:1.8V) | 6             | 11        | 0.5                  | ±1.0             | ±1.0    | 5              | 4.5-8.0     | 13               | 2.4               | 90             | Yes (Positive) | 9.0 x 7.5 x 5.0 |
| MYMGK00506ERSR  | 0.7-5.0 (typ.:5.0V) | 6             | 30        | 0.4                  | ±1.0             | ±1.0    | 12             | 8-15        | 24               | 2.6               | 95             | Yes (Positive) | 9.0 x 7.5 x 5.0 |
| MYMGK1R806FRSRD | 0.7-1.8 (typ.:1.8V) | 6             | 11        | 0.5                  | ±1.0             | ±1.0    | 5              | 4.5-8.0     | 13               | 2.4               | 90             | Yes (Positive) | 9.0 x 7.5 x 5.0 |
| MYMGK00506ERSRD | 0.7-5.0 (typ.:5.0V) | 6             | 30        | 0.4                  | ±1.0             | ±1.0    | 12             | 8-15        | 24               | 2.6               | 95             | Yes (Positive) | 9.0 x 7.5 x 5.0 |

- All specifications are at typical line voltage, Vout = typ. and full load, +25degC unless otherwise noted. Output capacitors are 100uF x 4 or 220uF x 2 ceramic. Input capacitors are 47uF x 2 or 22uF x 2 ceramic and plenty electrolytic capacitors. See detailed specifications Input and Output capacitors are necessary for our test equipment.
- Use adequate ground plane and copper thickness adjacent to the converter.

**PART NUMBER STRUCTURE**

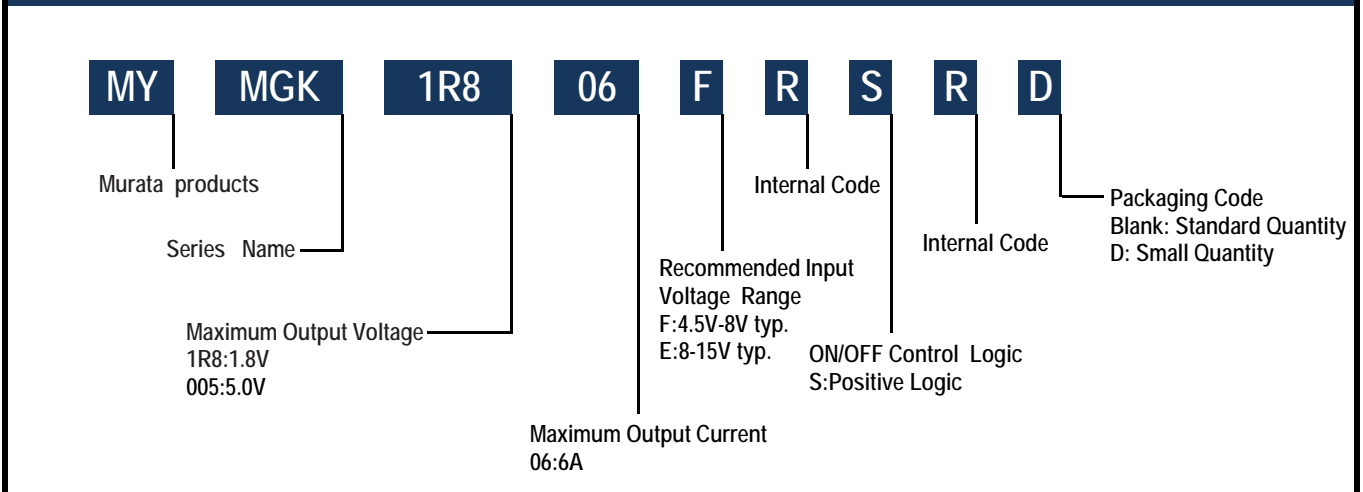

**Product Marking**

Because of the small size of these products, the product marking contains a character-reduced code to indicate the model number and manufacturing date code. Not all items on the marking are always used. Please note that the marking differs from the product photograph. Here is the layout of the Marking.

| Part Number     | Product Code |
|-----------------|--------------|
| MYMGK1R806FRSR  | 1R806FRS     |
| MYMGK00506ERSR  | 00506ERS     |
| MYMGK1R806FRSRD | 1R806FRS     |
| MYMGK00506ERSRD | 00506ERS     |

**Layout**

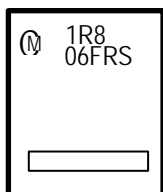

**Codes**

- Ⓜ 1Pin Marking  
1R806FRS Product code  
(Please see product code table beside)
- ▭ Internal manufacturing code

**COMMON SPECIFICATIONS**

| MECHANICAL(Common)                              | Conditions                           | Minimum                           | Typical | Maximum | Units  |
|---|--------------------------------------|-----------------------------------|---------|---------|--------|
| Mechanical Dimension                            | L x W x H                            | 9.0(typ.) x 7.5(typ.) x 5.0(max.) |         |         | mm     |
| Weight  |                                      |                                   | 1.2     |         | grams  |
| ENVIRONMENTAL(Common)                           | Conditions                           | Minimum                           | Typical | Maximum | Units  |
| Operating Ambient Temperature Range             | With Derating (Note 2,7)             | -40                               |         | 85      | degC   |
| Storage Temperature Range                       | Vin = Zero (no power)                | -40                               |         | 125     | degC   |
| Thermal Resistance(Reference data) $\psi_{j-c}$ | Vin=12V,Vout=5.0V,Iout=6A (Note 15)  |                                   | 5       |         | degC/W |
|   | Vin=12V,Vout=5.0V,Iout=3A (Note 15)  |                                   | 7.5     |         |        |
|   | Vin=5.0V,Vout=1.8V,Iout=6A (Note 15) |                                   | 6       |         |        |
|   | Vin=5.0V,Vout=1.8V,Iout=3A (Note 15) |                                   | 9       |         |        |
| Thermal Protection/Shutdown                     | Measured in module (Note9,14)        |                                   | 145     |         | degC   |
| Thermal Protection/Shutdown (Recovery)          | Measured in module (Note9,14)        |                                   | 105     |         | degC   |
| Moisture Sensitivity Level                      |                                      |                                   | 3       |         |        |

**FUNCTIONAL SPECIFICATIONS OF MYMGK1R806FRSR (Note 1)**

| ABSOLUTE MAXIMUM RATINGS  | Conditions  | Minimum | Typical     | Maximum | Units |
|---------------------------|---|---------|-------------|---------|-------|
| Input Voltage             |   | -0.3    |             | 9.6     | Vdc   |
| ON/OFF Pin                | Power on, referred to -Vin                          | -0.3    |             | Vin-1.5 | Vdc   |
| PGOOD/Trim Pins           | Power on, referred to -Vin                          |         | Source ONLY |         |       |
| Output Current            | Current-limited, no damage, short-circuit protected | 0       |             | 6       | A     |
| Storage Temperature Range | Vin = Zero (no power)                               | -40     |             | 125     | degC  |

Absolute maximums are stress ratings. Exposure of devices to greater than any of these conditions may adversely affect long-term reliability. Proper operation under conditions other than those listed in the Performance/Functional Specifications Table is not implied or recommended.

| INPUT                   | Conditions           | Minimum | Typical    | Maximum | Units |
|-------------------------|----------------------|---------|------------|---------|-------|
| Operating Voltage Range |                      | 4.5     | 5          | 8       | Vdc   |
| Start-up Threshold      | Rising input voltage |         | 4.3        |         | Vdc   |
| Under Voltage Shutdown  | Note 12              |         | 4.1        |         | Vdc   |
| Internal Filter Type    |                      |         | Capacitive |         |       |

**Input Current**

|                              |                                    |  |     |  |    |
|------------------------------|------------------------------------|--|-----|--|----|
| Full Load Conditions         | Vin = 5.0V, Vout = 1.8V, Iout = 6A |  | 2.4 |  | A  |
| Low Line                     | Vin = 4.5V, Vout = 1.8V, Iout = 6A |  | 2.7 |  | A  |
| No Load Current              | Iout = 0A, unit = ON               |  | 13  |  | mA |
| Shut-Down Mode Input Current |                                    |  | 1   |  | mA |

| GENERAL                  | Conditions                                   | Minimum | Typical   | Maximum | Units |
|--------------------------|--|---------|-----------|---------|-------|
| Efficiency               | Vin = 5.0V, Vout = 1.8V, Iout = 6A           |         | 90.4      |         | %     |
|                          | Vin = 5.0V, Vout = 1.0V, Iout = 6A           |         | 84.7      |         |       |
| Calculated MTBF (Note 3) | +40degC, Vin = 5.0V, Vout = 1.8V, Iout = 50% |         | 8,400,000 |         | hours |

| DYNAMIC CHARACTERISTICS     | Conditions                           | Minimum | Typical | Maximum | Units |
|-----------------------------|--------------------------------------|---------|---------|---------|-------|
| Fixed Switching Frequency   |                                      |         | 250     |         | kHz   |
| Startup Time (Vin ON)       | Vout = 1.8V (Vout=5% to 95% of Vout) |         | 2.4     |         | ms    |
| Startup Time (Remote ON)    | Vout = 1.8V (Vout=5% to 95% of Vout) |         | 2.4     |         | ms    |
| Dynamic Load Response       | 50-100% load step, Note 16           |         | 2.5     |         | A/us  |
| Dynamic Load Peak Deviation | same as above                        |         | ±3.0%   |         | Voset |

| FUNCTIONS                      | Conditions                                   | Minimum                               | Typical | Maximum | Units |
|--------------------------------|--|---------------------------------------|---------|---------|-------|
| Remote On/Off Control (Note 4) |  |                                       |         |         |       |
| Logic                          |  |                                       |         |         |       |
| ON State Range                 | ON = +1.5Vmin. to +Vin-1.5Vmax. or left open | 1.5                                   |         | Vin-1.5 | V     |
| OFF State Range                | OFF = -0.3V to +1.1Vmax.                     | -0.3                                  |         | 1.1     | V     |
| Control Current                | Open collector/drain                         |                                       |         | -       | mA    |
| Power-Good Output              |  |                                       |         |         |       |
| PGood TRUE (HI)                |  | (Voset x 95%) < Vout < (Voset x 113%) |         |         | V     |
| PGood FALSE (LO)               |  | Out of above range                    |         |         | V     |

FUNCTIONAL SPECIFICATIONS OF MYMGK1R806FRSR (Note 1)

| OUTPUT   | Conditions   | Minimum   | Typical    | Maximum | Units     |
|--|--|---|------------|---------|-----------|
| Total Output Power Range                           | See Derating                                       | 0   |            | 10.8    | W         |
| Voltage  |  |   |            |         |           |
| Output Voltage Range                               | Note 10  | 0.7   |            | 1.8     | Vdc       |
| Minimum Loading                                    |  |   | None       |         |           |
| Accuracy (50% load, untrimmed)                     | Vin = 5.0V, Vout = 1.8V, Cout = 400uF, Ta = 25degC | ±1  |            |         | % of Vout |
| Over Voltage Protection                            | Note 13  | >120%Vout   |            |         | Vdc       |
| Under Voltage Protection                           |  | <68%Vout  |            |         | Vdc       |
| Current  |  |   |            |         |           |
| Output Current Range                               | Note 2   | 0   |            | 6       | A         |
| Current Limit Inception                            | After warmup                                       |   | 9          |         | A         |
| Short Circuit                                      |  |   |            |         |           |
| Short Circuit Duration (remove short for recovery) | Output shorted to ground, no damage                |   | Continuous |         |           |
| Short Circuit Protection method                    | Note 5   |   | Hiccup     |         |           |
| Pre-bias Start-up                                  |  | Converter will start up if the external output voltage is less than set Vout. |            |         |           |
| Regulation (Note8)                                 |  |   |            |         |           |
| Load Regulation (Note 17)                          | Iout = min. to max.                                |   |            | ±1      | % of Vout |
| Temperature variation                              | Ta = -40 to 85 degC                                |   | ±1         |         | % of Vout |
| Total output voltage variation (Note 17)           | Fixed Input Voltage                                |   |            | ±3      | % of Vout |
| Ripple and Noise (20MHz bandwidth)                 | Note 6, pk-pk                                      |   | 1          |         | % of Vout |
| External Output Capacitance Range (Note 11)        |  | 400   |            | 3000    | uF        |

**FUNCTIONAL SPECIFICATIONS OF MYMGK00506ERSR (Note 1)**

| ABSOLUTE MAXIMUM RATINGS  | Conditions  | Minimum                               | Typical     | Maximum | Units |
|---|---|---------------------------------------|-------------|---------|-------|
| Input Voltage   |   | -0.3                                  |             | 16      | Vdc   |
| ON/OFF Pin  | Power on, referred to -Vin                          | -0.3                                  |             | 6.3     | Vdc   |
| PGOOD/Trim Pins   | Power on, referred to -Vin                          |                                       | Source ONLY |         |       |
| Output Current  | Current-limited, no damage, short-circuit protected | 0                                     |             | 6       | A     |
| Storage Temperature Range   | Vin = Zero (no power)                               | -40                                   |             | 125     | degC  |
| Absolute maximums are stress ratings. Exposure of devices to greater than any of these conditions may adversely affect long-term reliability. Proper operation under conditions other than those listed in the Performance/Functional Specifications Table is not implied or recommended. |   |                                       |             |         |       |
| INPUT   | Conditions  | Minimum                               | Typical     | Maximum | Units |
| Operating Voltage Range   |   | 8                                     | 12          | 15      | Vdc   |
| Start-up Threshold  | Rising input voltage                                |                                       | 6           |         | Vdc   |
| Under Voltage Shutdown  | Note 12   |                                       | 5.5         |         | Vdc   |
| Internal Filter Type  |   |                                       | Capacitive  |         |       |
| Input Current   |   |                                       |             |         |       |
| Full Load Conditions  | Vin = 12.0V, Vout = 5.0V, Iout = 6A                 |                                       | 2.6         |         | A     |
| Low Line  | Vin = 8.0V, Vout = 5.0V, Iout = 6A                  |                                       | 4.0         |         | A     |
| No Load Current   | Iout = 0A, unit = ON                                |                                       | 24          |         | mA    |
| Shut-Down Mode Input Current  |   |                                       | 1           |         | mA    |
| GENERAL   | Conditions  | Minimum                               | Typical     | Maximum | Units |
| Efficiency  | Vin = 12.0V, Vout = 5.0V, Io = 6A                   |                                       | 95.4        |         | %     |
|   | Vin = 12.0V, Vout = 1.0V, Io = 6A                   |                                       | 83.9        |         |       |
| Calculated MTBF (Note 3)  | +40degC, Vin = 12.0V, Vout = 5.0V, Iout = 50%       |                                       | 8,400,000   |         | hours |
| DYNAMIC CHARACTERISTICS   | Conditions  | Minimum                               | Typical     | Maximum | Units |
| Fixed Switching Frequency   |   |                                       | 300         |         | kHz   |
| Startup Time (Vin ON)   | Vout = 5.0V (Vout=5% to 95% of Vout)                |                                       | 4.8         |         | ms    |
| Startup Time (Remote ON)  | Vout = 5.0V (Vout=5% to 95% of Vout)                |                                       | 4.8         |         | ms    |
| Dynamic Load Response   | 50-100% load step, Note 16                          |                                       | 2.5         |         | A/us  |
| Dynamic Load Peak Deviation   | same as above                                       |                                       | ±3.0%       |         | Voset |
| FUNCTIONS   | Conditions  | Minimum                               | Typical     | Maximum | Units |
| Remote On/Off Control (Note 4)  |   |                                       |             |         |       |
| Logic   |   |                                       |             |         |       |
| ON State Range  | ON = +1.5Vmin. to +6.3V max. or left open           | 1.5                                   |             | 6.3     | V     |
| OFF State Range   | OFF = -0.3V to +1.1V max.                           | -0.3                                  |             | 1.1     | V     |
| Control Current   | Open collector/drain                                |                                       |             | -       | mA    |
| Power-Good Output   |   |                                       |             |         |       |
| PGood TRUE (HI)   |   | (Voset x 95%) < Vout < (Voset x 113%) |             |         |       |
| PGood FALSE (LO)  |   | Out of above range                    |             |         |       |

**FUNCTIONAL SPECIFICATIONS OF MYMGK00506ERSR (Note1)**

| OUTPUT   | Conditions  | Minimum   | Typical    | Maximum | Units     |
|--|---|---|------------|---------|-----------|
| Total Output Power                                 | See Derating  | 0   |            | 30      | W         |
| Voltage  |   |   |            |         |           |
| Output Voltage Range                               | Note 10   | 0.7   |            | 5.0     | Vdc       |
| Minimum Loading                                    |   |   | None       |         |           |
| Accuracy (50% load, untrimmed)                     | Vin = 12.0V, Vout = 5.0V, Cout = 400uF, Ta = 25degC | ±1  |            |         | % of Vout |
| Over voltage Protection                            | Note 13   | >120%Vout   |            |         | Vdc       |
| Under voltage Protection                           |   | <68%Vout  |            |         | Vdc       |
| Current  |   |   |            |         |           |
| Output Current Range                               | Note 2  | 0   |            | 6       | A         |
| Current Limit Inception                            | After warmup  |   | 9          |         | A         |
| Short Circuit                                      |   |   |            |         |           |
| Short Circuit Duration (remove short for recovery) | Output shorted to ground, no damage                 |   | Continuous |         |           |
| Short Circuit Protection Method                    | Note 5  |   | Hiccup     |         |           |
| Prebias Start-up                                   |   | Converter will start up if the external output voltage is less than set Vout. |            |         |           |
| Regulation   |   |   |            |         |           |
| Load Regulation (Note 17)                          | Iout = min. to max.                                 |   |            | ±1      | % of Vout |
| Temperature variation                              | Ta = -40 to 85 degC                                 |   | ±1         |         | % of Vout |
| Total output voltage variation (Note 17)           | Fixed input voltage                                 |   |            | ±3      | % of Vout |
| Ripple and Noise (20MHz bandwidth)                 | Note 6  |   | 1          |         | % of Vout |
| Maximum Capacitive Loading (Note 11)               |   | 400   |            | 3000    | uF        |

**Specification Notes**

(1) Specifications are typical at +25degC, Vin=typical +5.0V(MYMGK1R806FRSR) or +12V(MYMGK00506ERSR), Vout=typical +1.8V(MYMGK1R806FRSR) or +5V(MYMGK00506ERSR), full load, external capacitors and natural convection unless otherwise indicated. All models are tested and specified with external 220uF x 2 or 100uF x 4 ceramic output capacitors and 47uF x 2 (for MYMGK1R806FRSR) or 22uF x 2 (for MYMGK00506ERSR) ceramic and plenty electrolytic external input capacitors. All capacitors are low ESR types. These capacitors are necessary to accommodate our test equipment and may not be required to achieve specified performance in your applications. However, Murata recommends installation of these capacitors.

(2) Note that Maximum Power Derating curves indicate an average current at typical input voltage. At higher temperatures and/or no airflow, the DC/DC converter will tolerate brief full current outputs if the total RMS current over time does not exceed the Derating curve.

(3) Mean Time Between Failure is calculated using the Telcordia SR-332 method, +40degC, output load, natural air convection.

(4) The On/Off Control Input should use either a switch or an open collector/open drain transistor referenced to GND. A logic gate may also be used by applying appropriate external voltages which do not exceed +Vin

(5) "Hiccup" overcurrent operation repeatedly attempts to restart the converter with a brief, full-current output. If the overcurrent condition still exists, the restart current will be removed and then tried again. This short current pulse prevents overheating and damaging the converter. Once the fault is removed, the converter immediately recovers normal operation.

(6) Output noise may be further reduced by adding an external filter. At zero output current, the output may contain low frequency components which exceed the ripple specification. The output may be operated indefinitely with no load.

(7) All models are fully operational and meet published specifications, including "cold start" at -40degC.

(8) Regulation specifications describe the deviation as the line input voltage or output load current is varied from a midpoint value to either extreme.

(9) Thermal Protection/Shutdown is measured with the sensor in the center of the converter.

(10) Do not exceed maximum power specifications when adjusting the output trim.

(11) The maximum output capacitive loads depend on the Equivalent Series Resistance (ESR) of the external output capacitor and, to a lesser extent, the distance and series impedance to the load. Larger capacitors will reduce output noise but may change the transient response. Newer ceramic capacitors with very low ESR may require lower capacitor values to avoid instability. Thoroughly test your capacitors in the application.

(12) Do not allow the input voltage to degrade lower than the input under voltage shutdown voltage at all times. Otherwise, you risk having the converter turn off. The under voltage shutdown is not latching and will attempt to recover when the input is brought back into normal operating range.

(13) The outputs are intended to sink appreciable reverse current.

(14) When the temperature decreases below the turn-in threshold, the converter will automatically restart.

(15) The thermal resistances are only reference data, and they are measured with our evaluation board as below.  
50.8mm x 60.0mm x 1.6mm (4 Layer, 1oz copper each)FR-4.

(16) About di/dt condition, please refer to the table described later.

(17) Ensured by design. Not production tested.

Internal Circuit Diagrams

ON/OFF internal circuit diagram and using guide

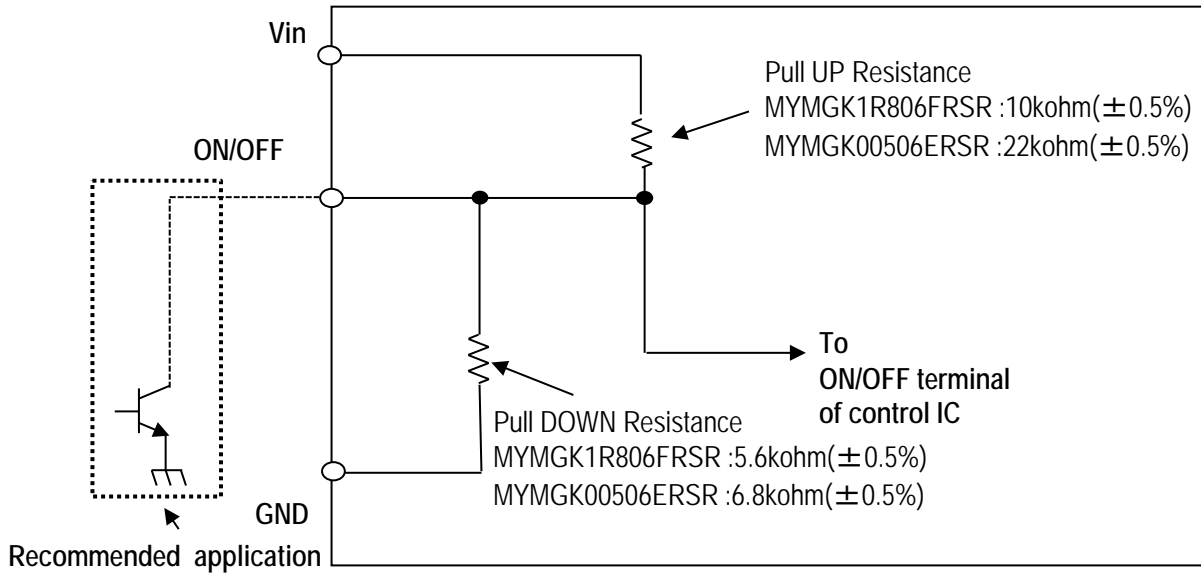

PowerGood(P.G) internal circuit diagram and using guide

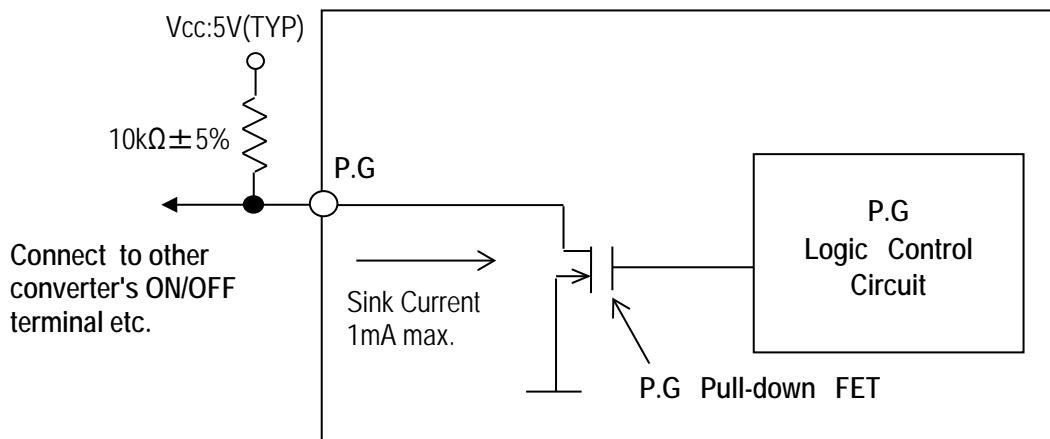

**PERFORMANCE DATA AND OSCILLOGRAMS OF MYMGK1R806FRSR**

Efficiency vs. Line Voltage and Load Current @ +25degC. (Vout = 0.7V)

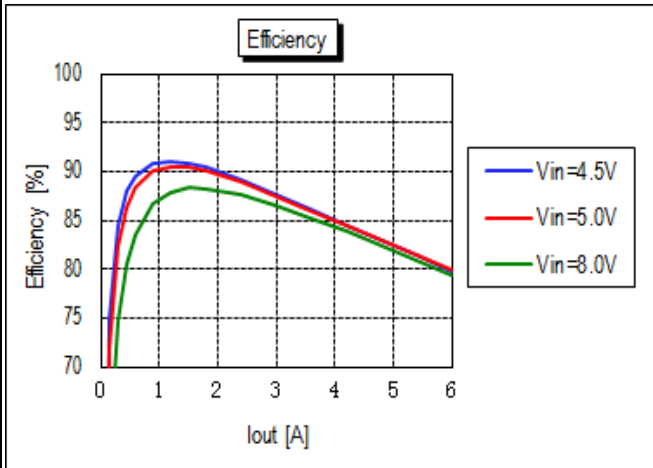

Vout vs. Line Voltage and Load Current @ +25degC. (Vout = 0.7V)

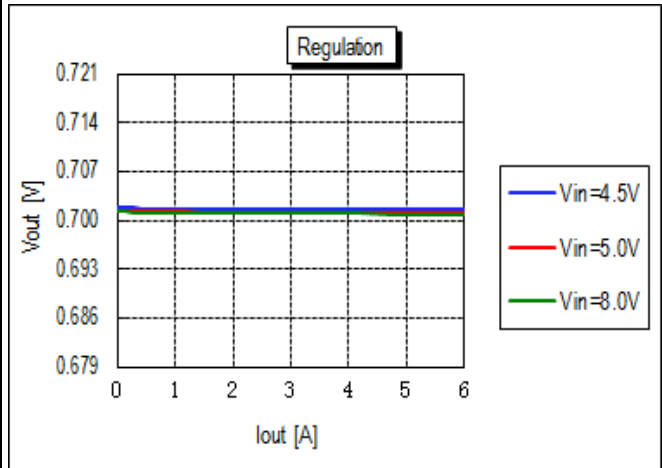

On/Off Enable Delay (Vin=5.0V, Vout=0.7V, Iout=6A, Cload=400uF)

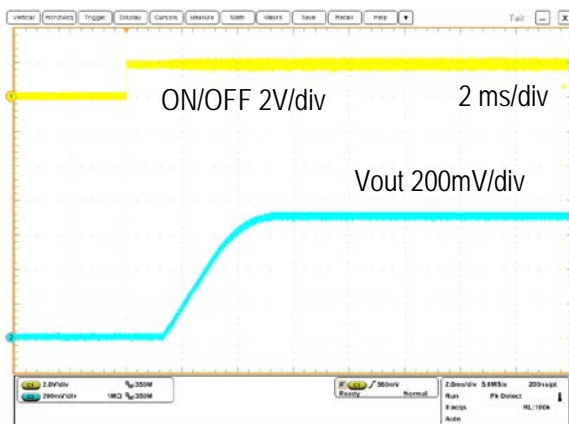

Output Ripple and Noise (Vin=5.0V, Vout=0.7V, Iout=6A, Cload=400uF, ScopeBW=20MHz)

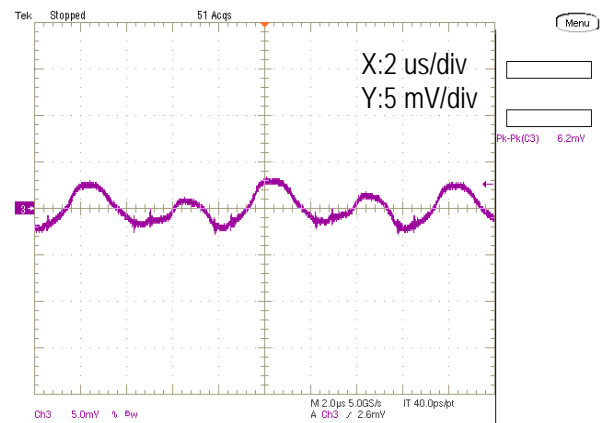

Step Load Transient Response (Vin=5.0V, Vout=0.7V, Cload=400uF, Iout=3A to 6A, 2.5A/us)

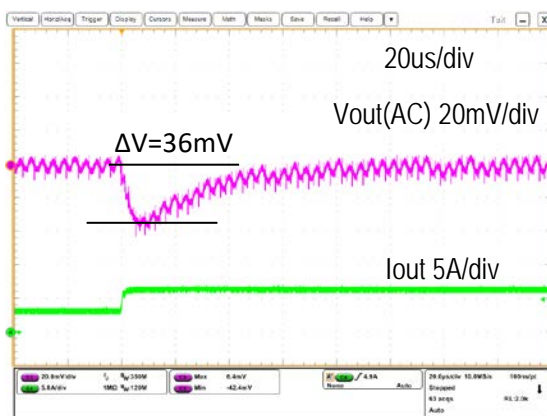

Step Load Transient Response (Vin=5.0V, Vout=0.7V, Cload=400uF, Iout=6A to 3A, 2.5A/us)

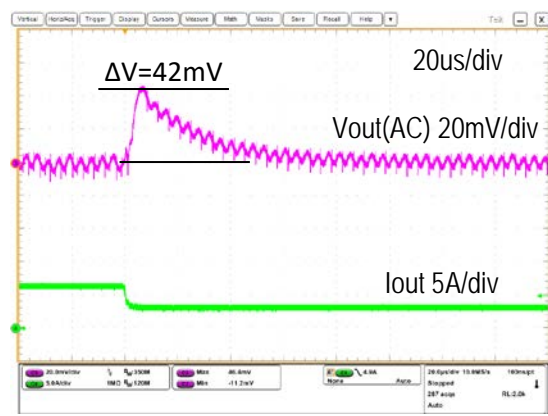



**PERFORMANCE DATA AND OSCILLOGRAMS OF MYMGK1R806FRSR**

Efficiency vs. Line Voltage and Load Current @ +25degC. (Vout = 1.0V)

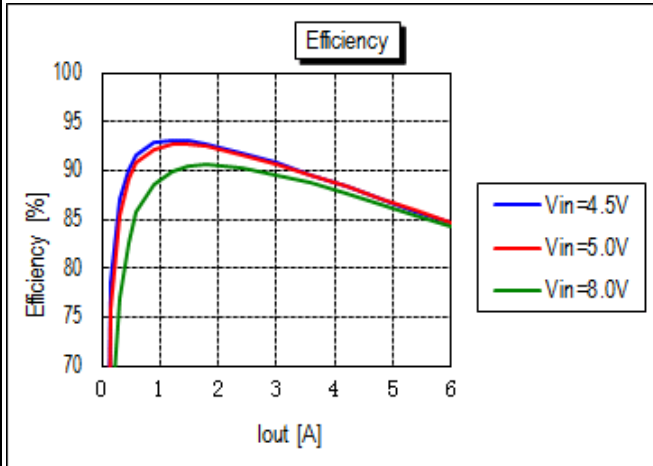

Vout vs. Line Voltage and Load Current @ +25degC. (Vout = 1.0V)

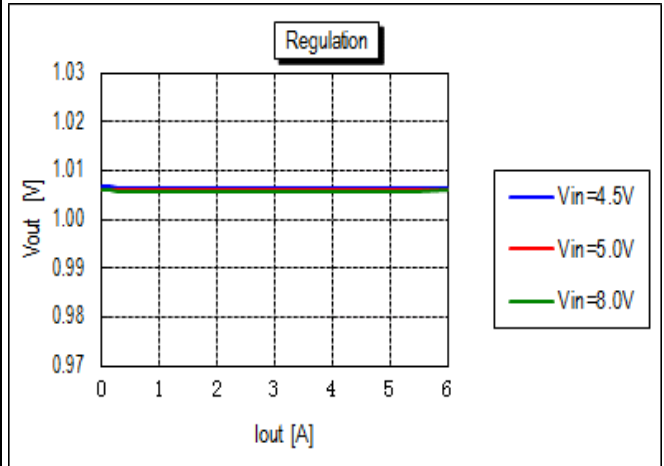

On/Off Enable Delay (Vin=5.0V, Vout=1.0V, Iout=6A, Cload=400uF)

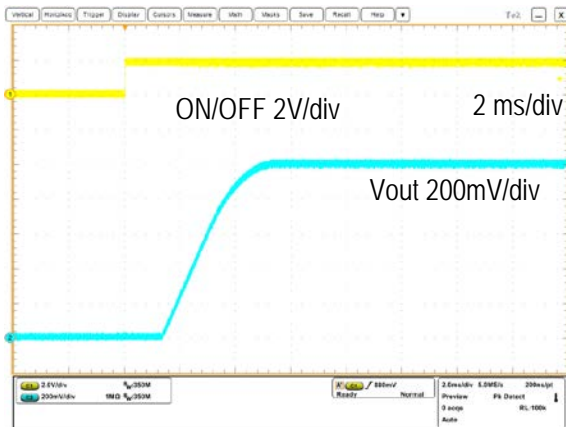

Output Ripple and Noise (Vin=5.0V, Vout=1.0V, Iout=6A, Cload=400uF, ScopeBW=20MHz)

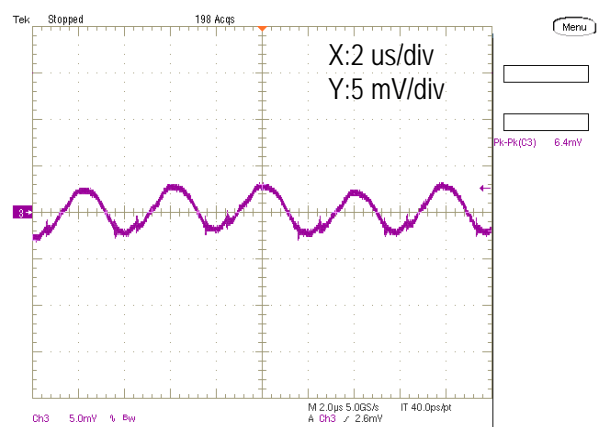

Step Load Transient Response (Vin=5.0V, Vout=1.0V, Cload=400uF, Iout=3A to 6A, 2.5A/us)

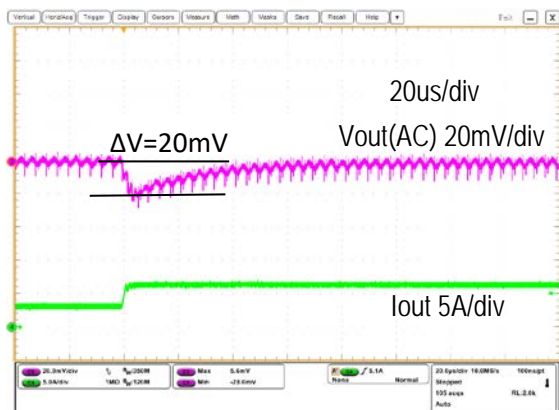

Step Load Transient Response (Vin=5.0V, Vout=1.0V, Cload=400uF, Iout=6A to 3A, 2.5A/us)

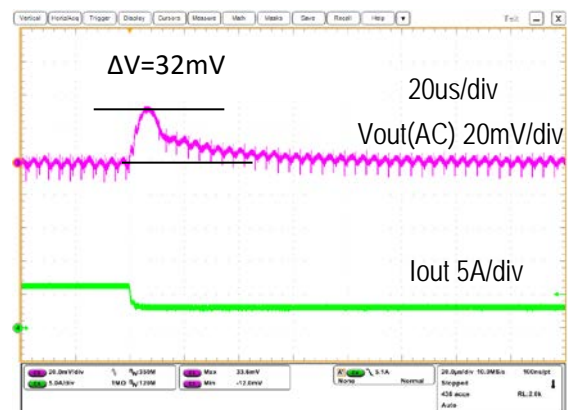

**PERFORMANCE DATA AND OSCILLOGRAMS OF MYMGK1R806FRSR**

Efficiency vs. Line Voltage and Load Current @ +25degC. (Vout = 1.8V)

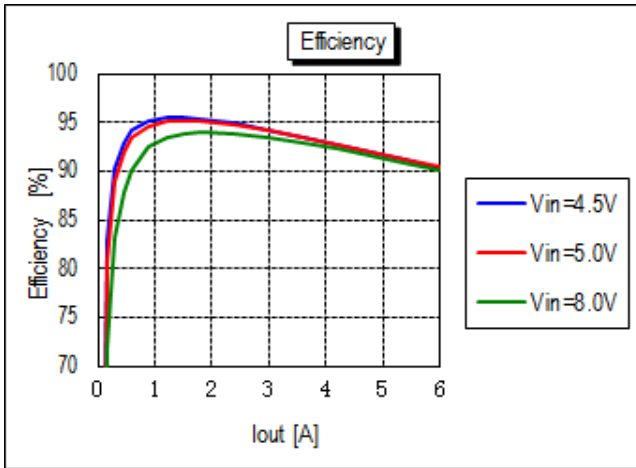

Vout vs. Line Voltage and Load Current @ +25degC. (Vout = 1.8V)

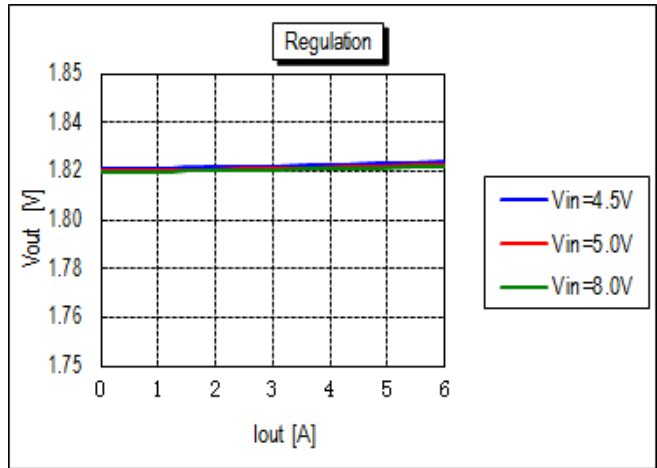

On/Off Enable Delay (Vin=5.0V, Vout=1.8V, Iout=6A, Cload=400uF)

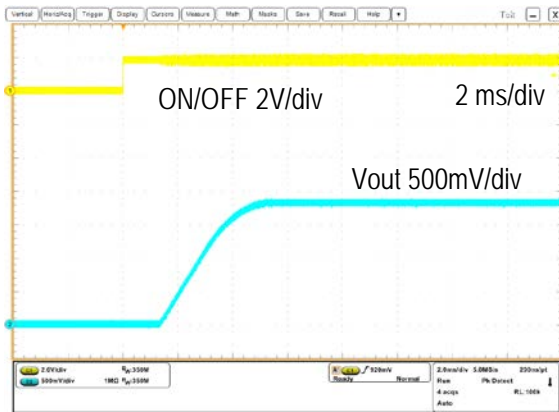

Output Ripple and Noise (Vin=5.0V, Vout=1.8V, Iout=6A, Cload=400uF, ScopeBW=20MHz)

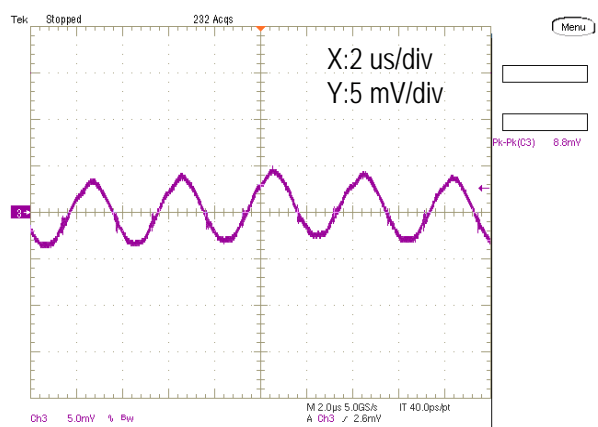

Step Load Transient Response (Vin=5.0V, Vout=1.8V, Cload=400uF, Iout=3A to 6A, 2.5A/us)

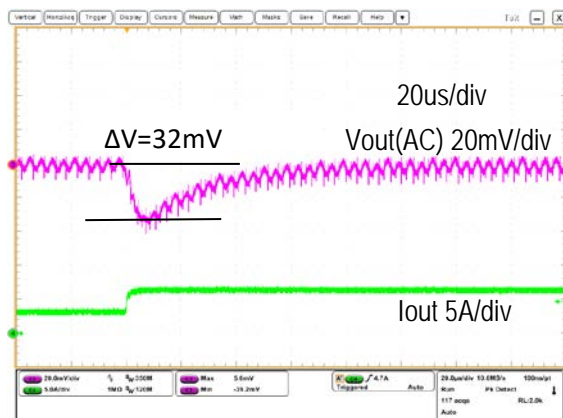

Step Load Transient Response (Vin=5.0V, Vout=1.8V, Cload=400uF, Iout=6A to 3A, 2.5A/us)

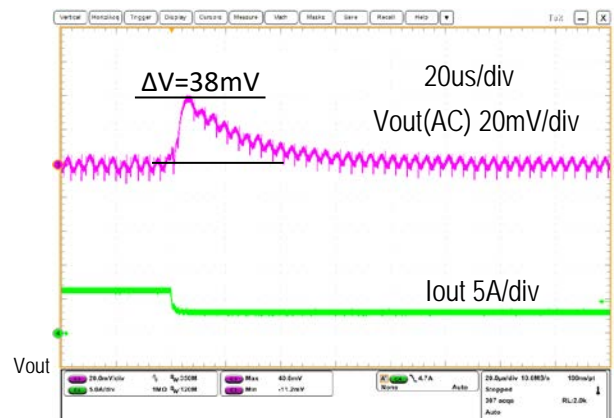

**PERFORMANCE DATA AND OSCILLOGRAMS OF MYMGK00506ERSR**

Efficiency vs. Line Voltage and Load Current @ +25degC. (Vout = 1.0V)

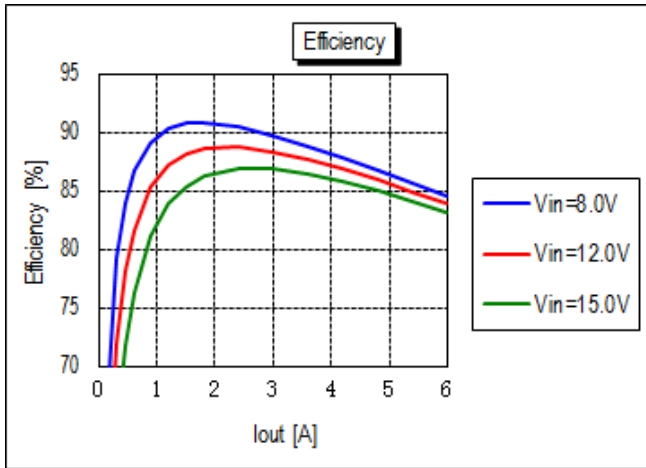

Vout vs. Line Voltage and Load Current @ +25degC. (Vout = 1.0V)

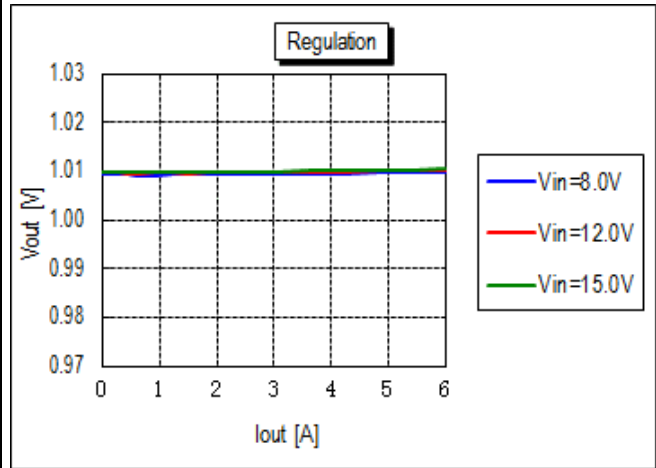

On/Off Enable Delay (Vin=12V, Vout=1.0V, Iout=6A, Cload=400uF)

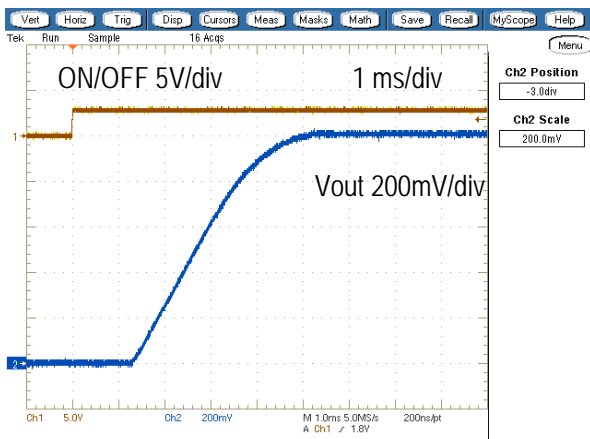

Output Ripple and Noise (Vin=12V, Vout=1.0V, Iout=6A, Cload=400uF, ScopeBW=20MHz)

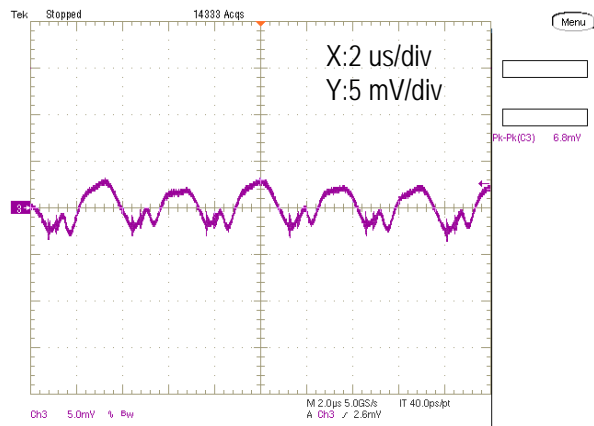

Step Load Transient Response (Vin=12V, Vout=1.0V, Cload=400uF, Iout=3A to 6A, 2.5A/us)

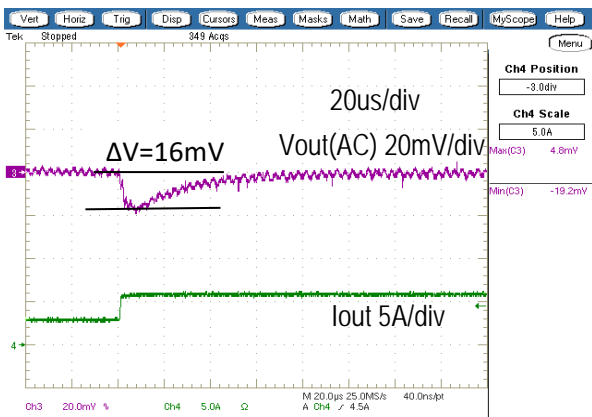

Step Load Transient Response (Vin=12V, Vout=1.0V, Cload=400uF, Iout=6A to 3A, 2.5A/us)

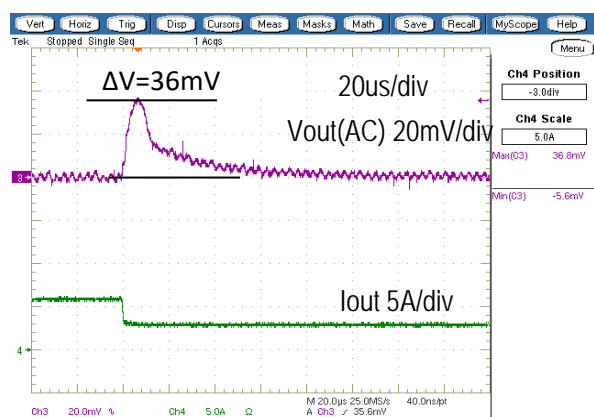

PERFORMANCE DATA AND OSCILLOGRAMS OF MYMGK00506ERSR

Efficiency vs. Line Voltage and Load Current @ +25degC. (Vout = 3.3V)

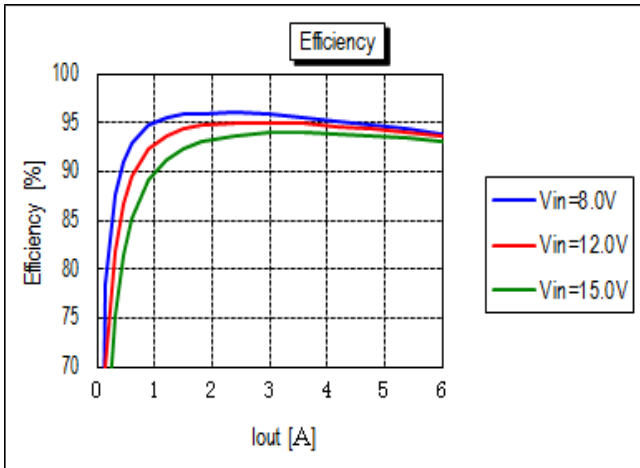

Vout vs. Line Voltage and Load Current @ +25degC. (Vout = 3.3V)

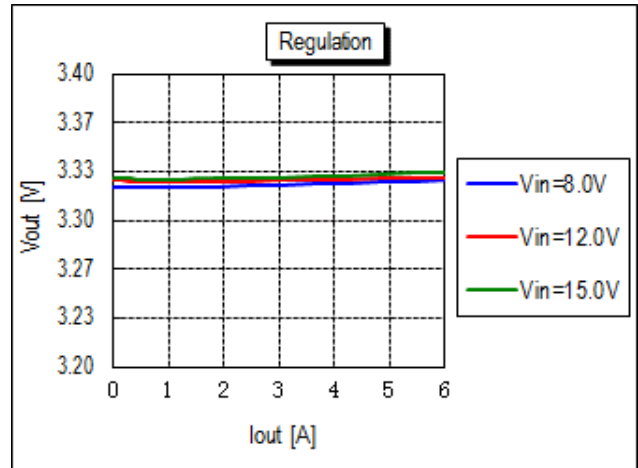

On/Off Enable Delay (Vin=12V, Vout=3.3V, Iout=6A, Cloud=400uF)

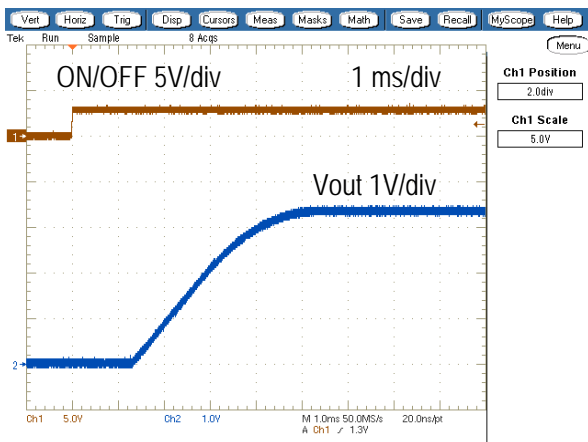

Output Ripple and Noise (Vin=12V, Vout=3.3V, Iout=6A, Cloud=400uF, ScopeBW=20MHz)

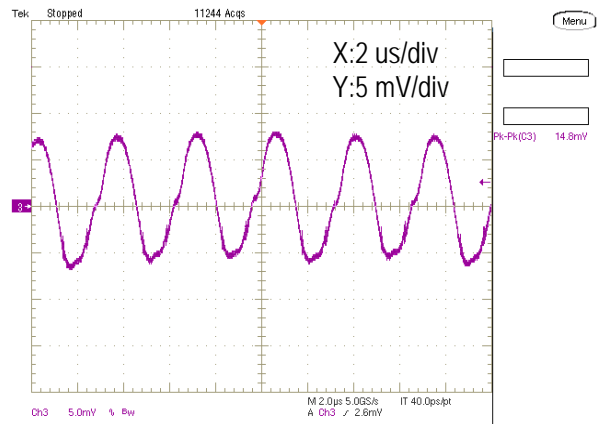

Step Load Transient Response (Vin=12V, Vout=3.3V, Cloud=400uF, Iout=3A to 6A, 2.5A/us)

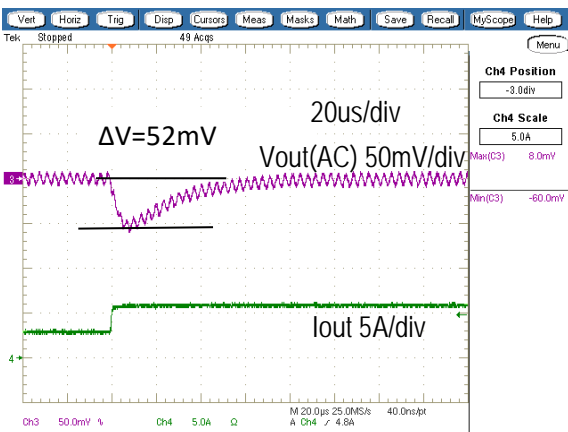

Step Load Transient Response (Vin=12V, Vout=3.3V, Cloud=400uF, Iout=6A to 3A, 2.5A/us)

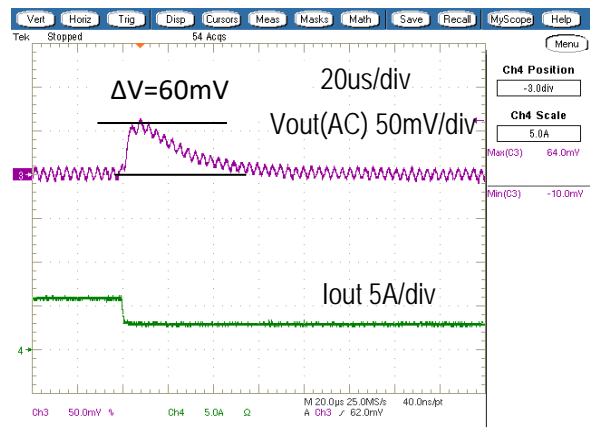

**PERFORMANCE DATA AND OSCILLOGRAMS OF MYMGK00506ERSR**

Efficiency vs. Line Voltage and Load Current @ +25degC. (Vout = 5.0V)

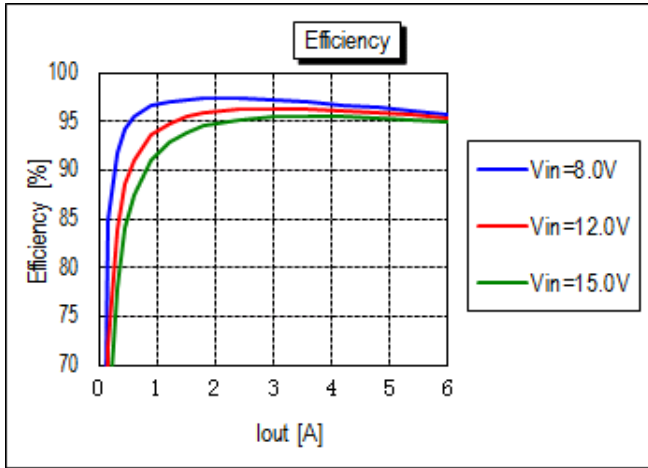

Vout vs. Line Voltage and Load Current @ +25degC. (Vout = 5.0V)

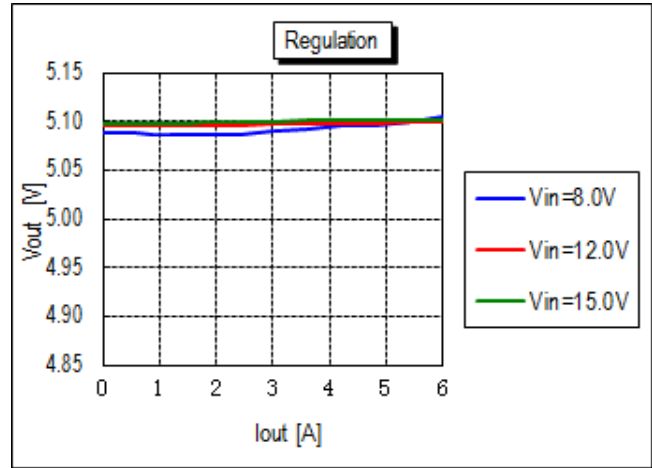

On/Off Enable Delay (Vin=12V, Vout=5.0V, Iout=6A, Cload=400uF)

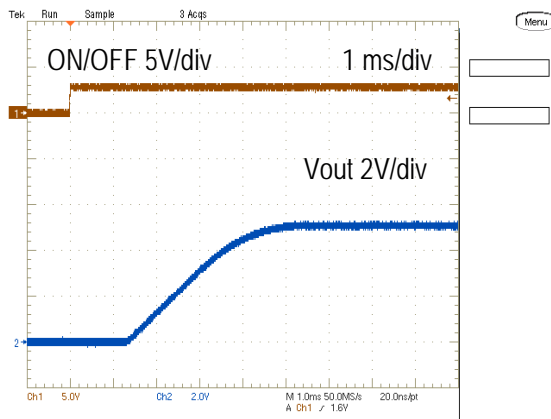

Output Ripple and Noise (Vin=12V, Vout=5.0V, Iout=6A, Cload=400uF, ScopeBW=20MHz)

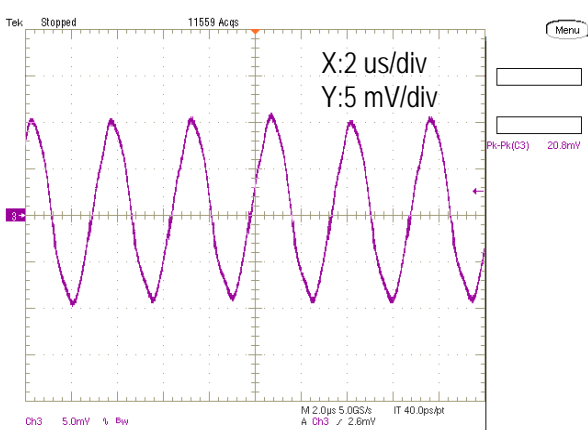

Step Load Transient Response (Vin=12V, Vout=5.0V, Cload=400uF, Iout=3A to 6A, 2.5A/us)

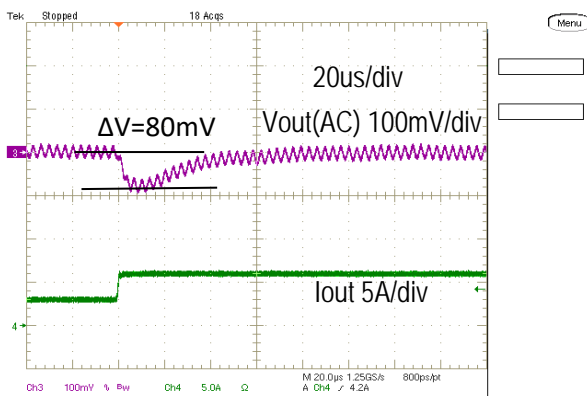

Step Load Transient Response (Vin=12V, Vout=5.0V, Cload=400uF, Iout=6A to 3A, 2.5A/us)

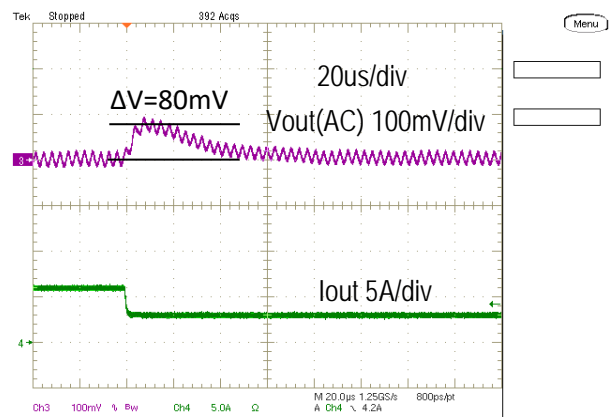

**THERMAL DERATINGS OF MYMGK1R806FRSR & MYMGK00506ERSR**

**MYMGK1R806FRSR**

Maximum Current Temperature Derating at Sea Level

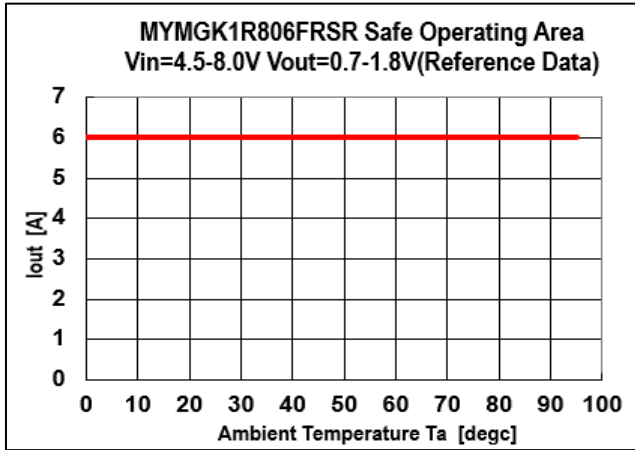

**MYMGK00506ERSR**

Maximum Current Temperature Derating at Sea Level

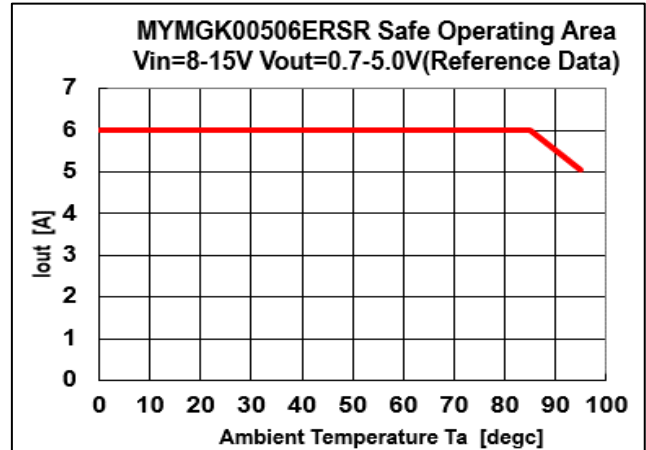

Thermal deratings are evaluated in following condition.

- Two products are mounted on 50.8mm x 60.0mm x 1.6mm (4 Layer, 1oz copper each)FR-4 board respectively.
- No forced air flow.

Surface temperature of the product: 117 degC max.

**TRANSIENT RESPONSE DATAS OF MYMGK1R806FRSR & MYMGK00506ERSR**

Transient response data at various conditions are showed in following table.

Output capacitance(Cout1+Cout2) can serve less than 3% x Vout of deviation for 3A load change(1A/us).

| Vout(V) | Vin(V) | Cout1(uF)* | Cout2(uF) | Voltage Deviation(mV)  |
|---------|--------|------------|-----------|------------------------|
|         |        |            |           | 3-6A Load Step (1A/us) |
| 0.7     | 5      | 440        | 400       | 21                     |
| 1.0     |        |            | 200       | 24                     |
| 1.8     |        |            | -         | 34                     |
| 1.0     | 12     | 400        | 200       | 25                     |
| 3.3     |        |            | -         | 54                     |
| 5.0     |        |            | -         | 72                     |

\*Cout1 is minimum output capacitance for the products.

**MECHANICAL SPECIFICATIONS**

Dimension and Pin Assignment

< Top View >

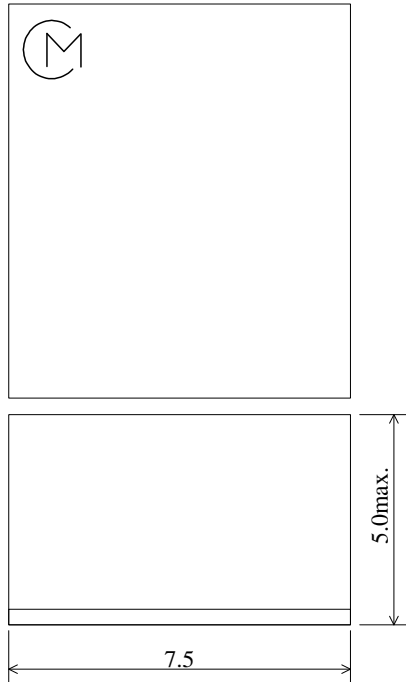

< Bottom View >

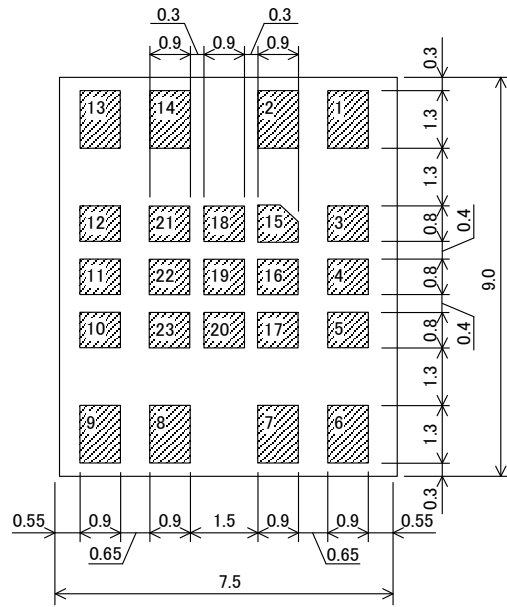

Unit:mm  
Tolerances  
± 0.15 mm

< Side View >

| INPUT/OUTPUT CONNECTIONS |                  |
|--------------------------|------------------|
| Pin No.                  | Function         |
| 1,2                      | Vin              |
| 3,8,9,10,13,14           | GND              |
| 4                        | Trim             |
| 5                        | Sense            |
| 6,7                      | Vout             |
| 11                       | PWGOOD           |
| 12                       | ON/OFF           |
| 15-23                    | GND(Thermal Pad) |

Recommended Board Land Pattern (Top View)

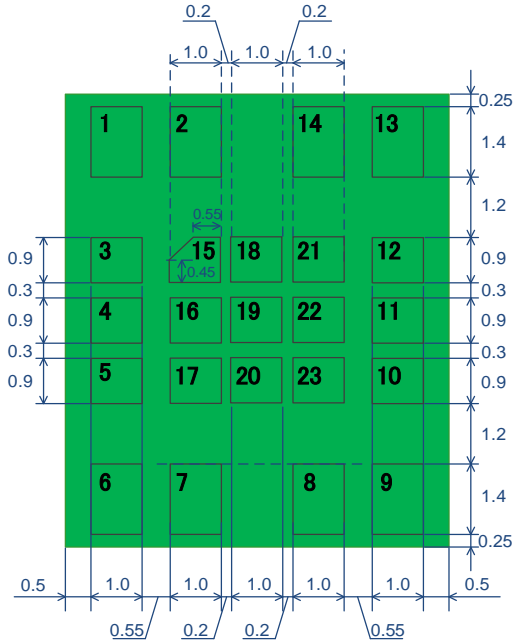

Unit:mm

Example of Pattern Layout (Top View)

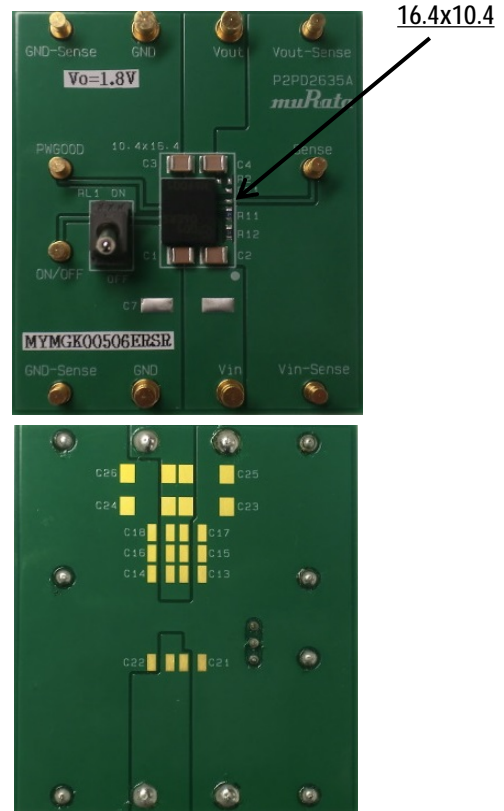
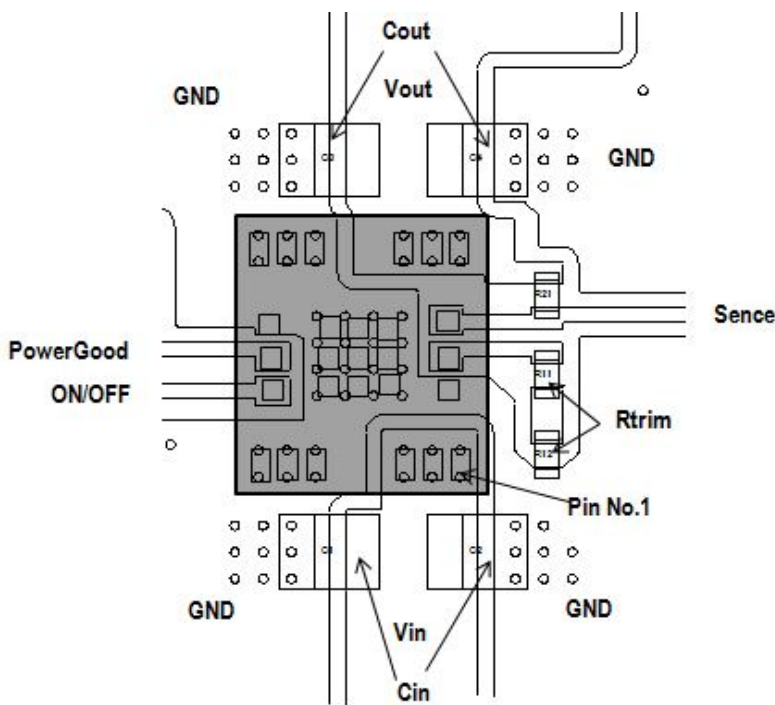



TAPE AND REEL INFORMATION

Tape Dimension

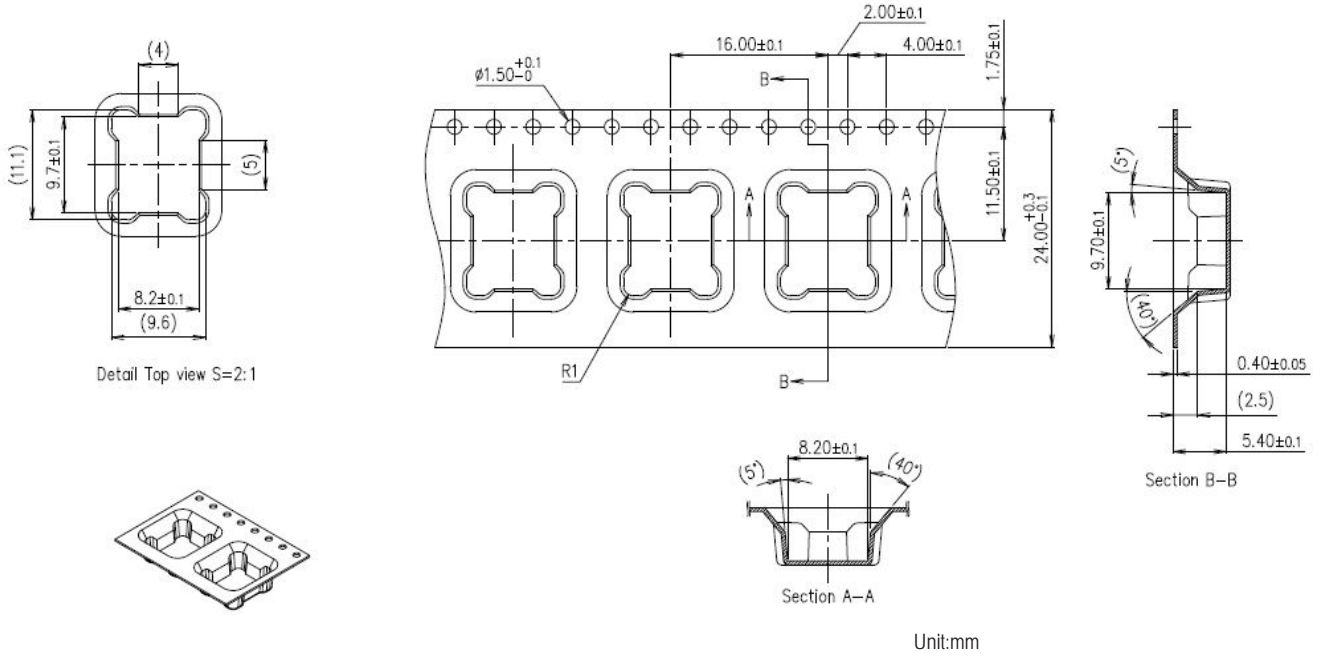

Reel Dimension

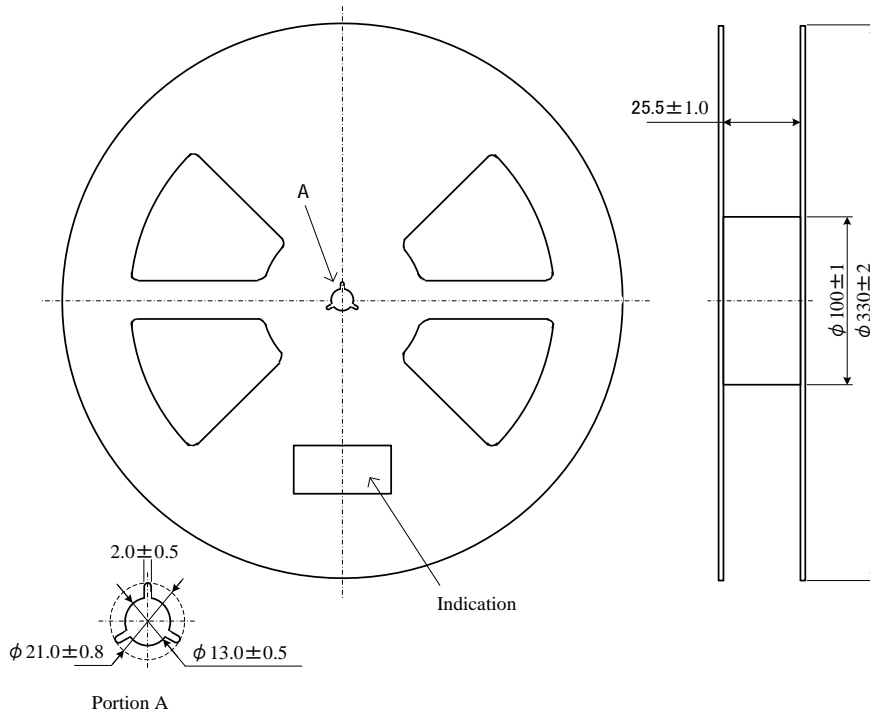

**TAPE SPECIFICATION**

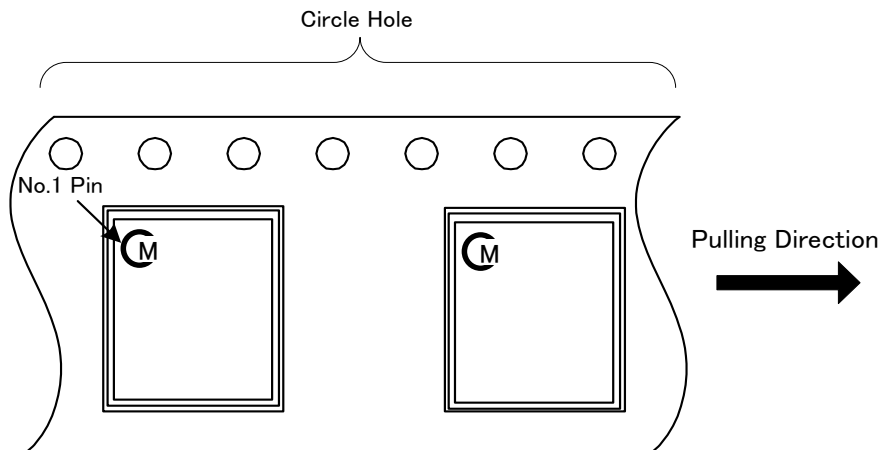
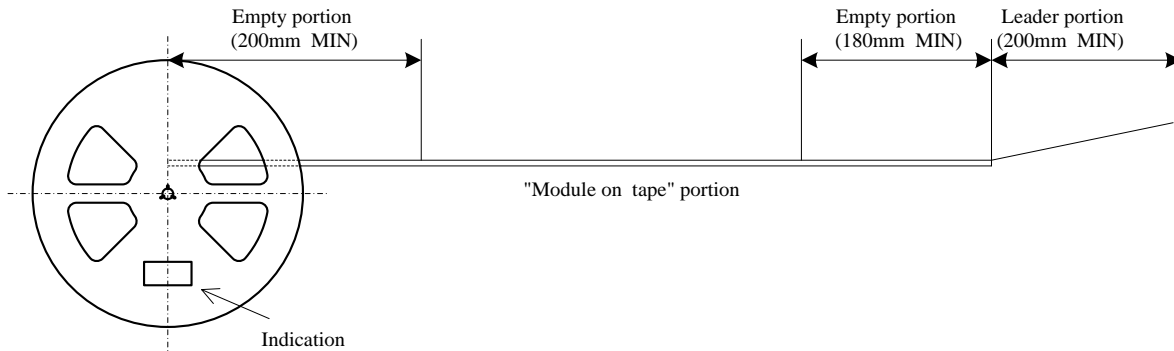

**Note**

1. The adhesive strength of the protective tape must be within 0.1-1.3N.
2. Each reel contains the quantities such as the table below.
3. Each reel set in moisture-proof packaging because of MSL 3.
4. No vacant pocket in "Module on tape" section.
5. The reel is labeled with Murata part number and quantity.
6. The color of reel is not specified.

| Part Number     | Qty |
|-----------------|-----|
| MYMGK1R806FRSR  | 400 |
| MYMGK00506ERSR  | 400 |
| MYMGK1R806FRSRD | 100 |
| MYMGK00506ERSRD | 100 |

**TECHNICAL NOTES**

**Input Fuse**

Certain applications and/or safety agencies may require fuses at the inputs of power conversion components. Fuses should also be used when there is the possibility of sustained input voltage reversal which is not current limited. For greatest safety, we recommend a fast blow fuse installed in the ungrounded input supply line.

The installer must observe all relevant safety standards and regulations.

For safety agency approvals, install the converter in compliance with the end-user safety standard.

**Input Under-Voltage Shutdown and Start-Up Threshold**

Under normal start-up conditions, converters will not begin to regulate properly until the ramping-up input voltage exceeds and remains at the Start-Up Threshold Voltage (see Specifications). Once operating, converters will not turn off until the input voltage drops below the Under-Voltage Shutdown Limit. Subsequent restart will not occur until the input voltage rises again above the Start-Up Threshold. This built-in hysteresis prevents any unstable on/off operation at a single input voltage.

Users should be aware however of input sources near the Under-Voltage Shutdown whose voltage decays as input current is consumed (such as capacitor inputs), the converter shuts off and then restarts as the external capacitor recharges. Such situations could oscillate. To prevent this, make sure the operating input voltage is well above the UV Shutdown voltage AT ALL TIMES.

**Start-Up Time**

Assuming that the output current is set at the rated maximum, the Vin to Vout Start-Up Time (see Specifications) is the time interval between the point when the ramping input voltage crosses the Start-Up Threshold and the fully loaded regulated output voltage enters and remains within its specified accuracy band. Actual measured times will vary with input source impedance, external input capacitance, input voltage slew rate and final value of the input voltage as it appears at the converter.

These converters include a soft start circuit to moderate the duty cycle of its PWM controller at power up, thereby limiting the input inrush current.

The On/Off Remote Control interval from On command to Vout regulated assumes that the converter already has its input voltage stabilized above the Start-Up Threshold before the On command. The interval is measured from the On command until the output enters and remains within its specified accuracy band. The specification assumes that the output is fully loaded at maximum rated current. Similar conditions apply to the On to Vout regulated specification such as external load capacitance and soft start circuitry.

**Recommended Input Filtering**

The user must assure that the input source has low AC impedance to provide dynamic stability and that the input supply has little or no inductive content, including long distributed wiring to a remote power supply. For best performance, we recommend installing a low-ESR capacitor immediately adjacent to the converter's input terminals.

The capacitor should be a ceramic type such as the Murata GRM32 series and a electrolytic type such as Panasonic OS-CON series. Initial suggested capacitor values are 22 uF x 2 or 47uF x 2 ceramic type and 1000uF x 1 electrolytic type, rated at twice the expected maximum input voltage. Make sure that the input terminals do not go below the under voltage shutdown voltage at all times. More input bulk capacitance may be added in parallel (either electrolytic or tantalum) if needed.

**Recommended Output Filtering**

The converter will achieve its rated output ripple and noise with additional external capacitor. The user may install more external output capacitance reduce the ripple even further or for improved dynamic response. Again, use low-ESR ceramic (Murata GRM32 series). Initial values of 220 uF x 2 or 100 uF x 4 ceramic type may be tried, either single or multiple capacitors in parallel. Mount these close to the converter. Measure the output ripple under your load conditions. Use only as much capacitance as required to achieve your ripple and noise objectives. Excessive capacitance can make step load recovery sluggish or possibly introduce instability. Do not exceed the maximum rated output capacitance listed in the specifications.

**Input Ripple Current and Output Noise**

All models in this converter series are tested and specified for input reflected ripple current and output noise using designated external input/output components, circuits and layout as shown in the figures below.

In the figure below, the two copper strips simulate real-world printed circuit impedances between the power supply and its load. In order to minimize circuit errors and standardize tests between units, scope measurements should be made using BNC connectors or the probe ground should not exceed one half inch and soldered directly to the test circuit.

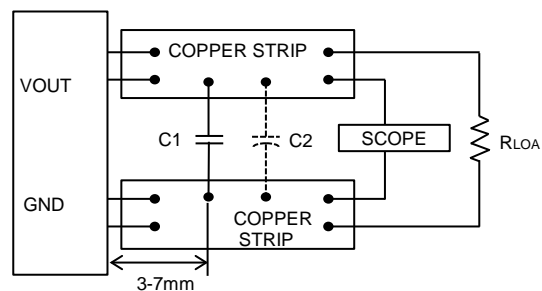

C1=220uF x 2 or 100uF x 4 CERAMIC  
C2=OPEN  
Figure: Measuring Output Ripple and Noise

**Minimum Output Loading Requirements**

All models regulate within specification and are stable under no load to full load conditions. Operation under no load might however slightly increase output ripple and noise.

**Thermal Shutdown**

To prevent many over temperature problems and damage, these converters include thermal shutdown circuitry. If environmental conditions cause the temperature of the DC/DC's to rise above the Operating Temperature Range up to the shutdown temperature, an on-board electronic temperature sensor will power down the unit. When the temperature decreases below the turn-on threshold, the converter will automatically restart.

**CAUTION:** If you operate too close to the thermal limits, the converter may shut down suddenly without warning. Be sure to thoroughly verify your application to avoid unplanned thermal shutdown.

#### Temperature Derating Curves

The graphs in this data sheet illustrate typical operation under a variety of conditions. The derating curves show the maximum continuous ambient air temperature. Note that these are AVERAGE measurements.

Note that the temperatures are of the ambient airflow, not the converter itself which is obviously running at higher temperature than the outside air. Also note that very low flow rates (below about 25 LFM) are similar to "natural convection," that is, not using fan-forced airflow. Murata makes Characterization measurements in a closed cycle wind tunnel with calibrated airflow. We use both thermocouples and an infrared camera system to observe thermal performance.

**CAUTION:** These graphs are all collected at slightly above Sea Level altitude. Be sure to reduce the derating for higher density altitude.

#### Output Current Limiting

Current limiting inception is defined as the point at which full power falls below the rated tolerance. See the Performance/Functional Specifications. Note particularly that the output current may briefly rise above its rated value in normal operation as long as the average output power is not exceeded. This enhances reliability and continued operation of your application. If the output current is too high, the converter will enter the short circuit condition.

#### Output Short Circuit Condition

When a converter is in current-limit mode, the output voltage will drop as the output current demand increases. Following a time-out period, the converter will restart, causing the output voltage to begin ramping up to its appropriate value. If the short-circuit condition persists, another shutdown cycle will initiate. This rapid on/off cycling is called "hiccup mode". The hiccup cycling reduces the average output current, thereby preventing excessive internal temperatures and/or component damage. A short circuit can be tolerated indefinitely.

The "hiccup" system differs from older latching short circuit systems because you do not have to power down the converter to make it restart. The system will automatically restore operation as soon as the short circuit condition is removed.

#### UVP/OVP Function

This product monitors a resistor divided feedback voltage to detect over and under voltage. When the feedback voltage becomes lower than 68% of the target voltage, after 1ms, the product latches OFF. The converter restarts after a hiccup delay (about 16 ms). This function is enabled 1.5-ms after the soft-start is completed.

When the feedback voltage becomes higher than 120% of the target voltage, the circuit operates sink-mode to decrease output voltage. If the output voltage reaches UV threshold, the device restarts after a hiccup delay. If the OV condition remains, the converter will not start until the OV condition is removed.

#### Remote On/Off Control

Please refer to the Connection Diagram on page 1 for On/Off connections.

Positive logic models are enabled when the On/Off pin is left open or is pulled high to +Vin with respect to -Vin. An internal bias current causes the open pin to rise to +Vin. Positive-polarity devices are disabled when the On/Off is grounded or brought to within a low voltage (see Specifications) with respect to -Vin.

Dynamic control of the On/Off function should be able to sink appropriate signal current when brought low and withstand appropriate voltage when brought high. Be aware too that there is a finite time in milliseconds (see Specifications) between the time of On/Off Control activation and stable, regulated output. This time will vary slightly with output load type and current and input conditions.

#### Output Capacitive Load

Users should only consider adding capacitance to reduce switching noise and/or to handle spike current load steps. Install only enough capacitance to achieve noise objectives. Excess external capacitance may cause regulation problems, degraded transient response and possible oscillation or instability.

#### Soldering Guidelines

Murata recommends the specifications below when installing these converters. These specifications vary depending on the solder type.

Exceeding these specifications may cause damage to the product. Your production environment may differ therefore please thoroughly review these guidelines with your process engineers.

| Reflow Solder Operations for surface-mount products (SMT) |                            |
|---|----------------------------|
| For Sn/Ag/Cu based solders:                               |                            |
| Preheat Temperature                                       | Less than 1degC per second |
| Time over Liquidus  | 45 to 75 seconds           |
| Maximum Peak Temperature                                  | 250degC                    |
| Cooling Rate  | Less than 3degC per second |
| For Sn/Pb based solders:                                  |                            |
| Preheat Temperature                                       | Less than 1degC per second |
| Time over Liquidus  | 60 to 75 seconds           |
| Maximum Peak Temperature                                  | 235degC                    |
| Cooling Rate  | Less than 3degC per second |

**Recommended Lead-free Solder Reflow Profile**

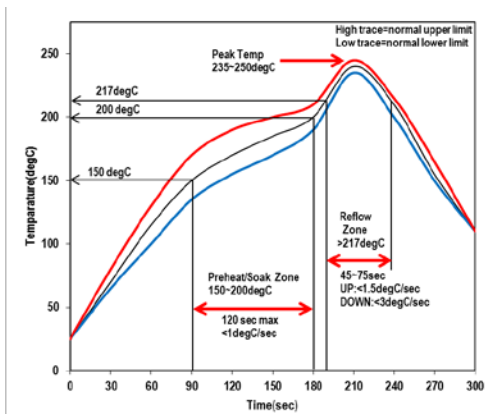

**CAUTION:** Do not reflow the DC-DC converter as follows, because the DC-DC converter may fall from the substrate during reflowing.

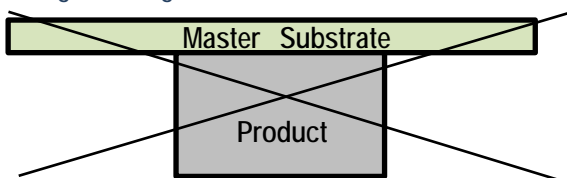

**Pb-free solder processes**

For Pb-free solder processes, the product is qualified for MSL 3 according to IPC/JEDEC standard J-STD-020C. During reflow PRODUCT must not exceed 250 degC at any time.

**Dry Pack Information**

Products intended for Pb-free reflow soldering processes are delivered in standard moisture barrier bags according to IPC/JEDEC standard J-STD-033. (Handling, packing, shipping and use of moisture/reflow sensitivity surface mount devices.) Using products in high temperature Pb-free soldering processes requires dry pack storage and handling. In case the products have been stored in an uncontrolled environment and no longer can be considered dry, the modules must be baked according to J-STD-033.

**Output Voltage Adjustment**

The output voltage may be adjusted over a limited range by connecting an external trim resistor (Rtrim) between the Trim pin and GND pin. The Rtrim resistor must be a 1/10W precision metal film type, ±0.5% accuracy (or better) with low temperature coefficient, ±100 ppm/degC or better. Mount the resistor close to the converter with very short leads or use a surface mount trim resistor.

| Output Voltage | Estimated Rtrim (kohm) |                |
|----------------|------------------------|----------------|
|                | MYMGK1R806FRSR         | MYMGK00506ERSR |
| 0.7V           | 33+27                  | 33+27          |
| 1.0V           | 15                     | 15             |
| 1.2V           | 10                     | 10             |
| 1.5V           | 4.7+2.0                | 4.7+2.0        |
| 1.8V           | 4.7+0.3                | 4.7+0.3        |
| 2.5V           | —                      | 3.0+0.16       |
| 3.3V           | —                      | 2.2+0.022      |
| 5.0V           | —                      | 1.2+0.16       |

**Resistor Trim Equation**

$$R_{trim} \text{ (kohm)} = \frac{6}{V_{out} - 0.6}$$

**Output Voltage Remote Sense**

This function is capable to compensate up the voltage drop between the output and input of load. The sense range depends on the maximum voltage allowing on the Vout pin. The sense trace should be short as possible and shielded by GND line or else to reduce noise susceptibility. The sense line length is recommended within 10cm for output voltage stability. If the remote sense is not needed, The Sense pin should be shorted to the Vout pin.

**Power Good(P.G)**

These products has power-good output that indicates high when switcher output is within the target. The power-good function is activated after soft-start has finished. If the output voltage becomes within +10% and -5% of the target value, internal comparators detect power-good state and the power-good signal becomes high after a 1-ms internal delay. If the output voltage goes outside of +15% or -10% of the target value, the power-good signal becomes low after two microsecond (2-μs) internal delay. The power-good output is an open drain output and must be pulled up internally.

APPENDIX

Test Circuit

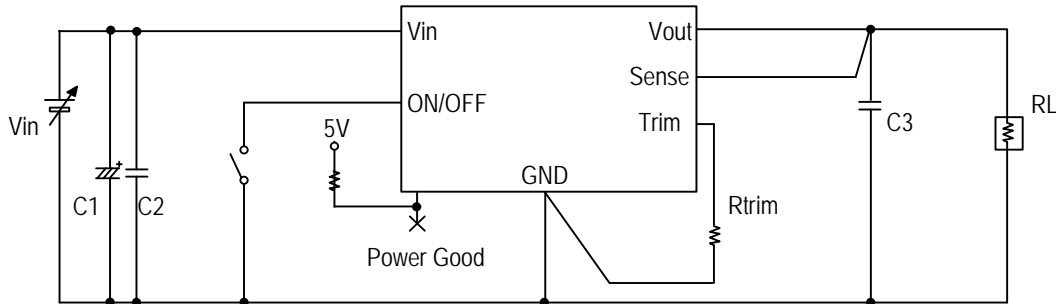

Vin: DC Power Supply  
RL: Electronic Load Device

MYMGK1R806FRSR

- C1: 1000uF/25V x 1pc Electrolysis Capacitor
- C2: 47uF / 10V x 2pcs (GRM32ER71A476KE15, Murata)
- C3: 220uF / 4V x 2pcs (GRM32EC80G227ME05, Murata)

MYMGK00506ERSR

- C1: 1000uF/25V x 1pc Electrolysis Capacitor
- C2: 22uF / 25V x 2pcs (GRM32ER71E226KE15, Murata)
- C3:  $\begin{cases} V_{out}=0.7-3.0V \Rightarrow 220uF / 4V \times 2\text{pcs (GRM32EC80G227ME05, Murata)} \\ V_{out}=3.0-5.0V \Rightarrow 100uF / 6.3V \times 4\text{pcs (GRM32EE70J107ME15, Murata)} \end{cases}$

Do not connect any additional components between the Trim pin and Vout or between the Trim and Sense pins. Use only the specified connections.  
If there is a long inductive cable length between the input power source and converter, then some additional bulk decoupling capacitance (eg. up to 1000uF) may be necessary to ensure a low AC impedance power source.  
This would typically be aluminum electrolytic type and does not need to be close to the input terminals of converter.



This product is subject to the following [operating requirements](#) and the [Life and Safety Critical Application Sales Policy](#):  
Refer to: <https://power.murata.com/en/requirements>

Murata Manufacturing Co., Ltd makes no representation that the use of its products in the circuits described herein, or the use of other technical information contained herein, will not infringe upon existing or future patent rights. The descriptions contained herein do not imply the granting of licenses to make, use, or sell equipment constructed in accordance therewith. Spec and cautions are subject to change without notice. © 2018 Murata Manufacturing Co., Ltd

# Mouser Electronics

Authorized Distributor

Click to View Pricing, Inventory, Delivery & Lifecycle Information:

[Murata:](#)

[MYMGK00506ERSR](#)

Компания «Life Electronics» занимается поставками электронных компонентов импортного и отечественного производства от производителей и со складов крупных дистрибьюторов Европы, Америки и Азии.

С конца 2013 года компания активно расширяет линейку поставок компонентов по направлению коаксиальный кабель, кварцевые генераторы и конденсаторы (керамические, пленочные, электролитические), за счёт заключения дистрибьюторских договоров

Мы предлагаем:

- Конкурентоспособные цены и скидки постоянным клиентам.
- Специальные условия для постоянных клиентов.
- Подбор аналогов.
- Поставку компонентов в любых объемах, удовлетворяющих вашим потребностям.
- Приемлемые сроки поставки, возможна ускоренная поставка.
- Доставку товара в любую точку России и стран СНГ.
- Комплексную поставку.
- Работу по проектам и поставку образцов.
- Формирование склада под заказчика.
- Сертификаты соответствия на поставляемую продукцию (по желанию клиента).
- Тестирование поставляемой продукции.
- Поставку компонентов, требующих военную и космическую приемку.
- Входной контроль качества.
- Наличие сертификата ISO.

В составе нашей компании организован Конструкторский отдел, призванный помогать разработчикам, и инженерам.

Конструкторский отдел помогает осуществить:

- Регистрацию проекта у производителя компонентов.
- Техническую поддержку проекта.
- Защиту от снятия компонента с производства.
- Оценку стоимости проекта по компонентам.
- Изготовление тестовой платы монтаж и пусконаладочные работы.



Тел: +7 (812) 336 43 04 (многоканальный)

Email: [org@lifeelectronics.ru](mailto:org@lifeelectronics.ru)