

# PS2561D-1, PS2561DL-1, PS2561DL1-1, PS2561DL2-1

R08DS0181EJ0100  
Rev.1.00  
May 11, 2020

DIP PHOTOCOUPLER OPERATING AMBIENT TEMPERATURE 110°C

## DESCRIPTION

The PS2561D-1 is an optically coupled isolator containing a GaAs light emitting diode and an NPN silicon phototransistor.

The PS2561D-1 is in a plastic DIP (Dual In-line Package) and the PS2561DL-1 is lead bending type (Gull-wing) for surface mount.

The PS2561DL1-1 is lead bending type for long creepage distance.

The PS2561DL2-1 is lead bending type for long creepage distance (Gull-wing) for surface mount.

## FEATURES

- Operating ambient temperature: 110°C
- High isolation voltage (BV = 5 000 Vr.m.s.)
- High collector to emitter voltage ( $V_{CEO} = 80\text{ V}$ )
- High current transfer ratio (CTR = 160% TYP.)
- High-speed switching ( $t_r = 3\ \mu\text{s}$  TYP.,  $t_f = 5\ \mu\text{s}$  TYP.)
- Ordering number of taping product: PS2561DL-1-F3 : 2 000 pcs/reel
- : PS2561DL2-1-F3 : 2 000 pcs/reel
- Pb-Free product
- Safety standards
  - UL approved: UL1577, Double protection
  - CSA approved: CAN/CSA-C22.2 No. 62368-1, Reinforced insulation
  - BSI approved: BS EN 62368-1, Reinforced insulation
  - SEMKO approved: EN 62368-1, IEC 62368-1, Reinforced insulation
  - NEMKO approved: EN 62368-1, Reinforced insulation
  - FIMKO approved: EN 62368-1, Reinforced insulation
  - DEMKO approved: EN 62368-1, Reinforced insulation
  - CQC approved: GB8898, GB4943.1, Reinforced insulation
  - VDE approved: DIN EN 60747-5-5 (Option)

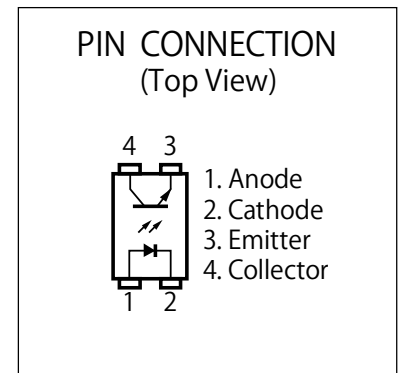

## APPLICATIONS

- Power supply
- Telephone/FAX.
- FA/OA equipment
- Programmable logic controllers

**PACKAGE DIMENSIONS (UNIT: mm)**

**DIP Type**



**Long Creepage Distance**



**Lead Bending Type**



**Long Creepage Distance (Gull-Wing)**



Weight ( 4-pin DIP ) : 0.26 g (typ.)

**PHOTOCOUPLER CONSTRUCTION**

Parameter	PS2561D-1, PS2561DL-1	PS2561DL1-1, PS2561DL2-1
Air Distance (MIN.)	7 mm	8 mm
Creepage Distance (MIN.)	7 mm	8 mm
Isolation Distance (MIN.)	0.4 mm	0.4 mm

### MARKING EXAMPLE



### ORDERING INFORMATION

Part Number	Order Number *1	Solder Plating Specification	Packing Style	Safety Standard Approval	Application Part Number *2	
PS2561D-1	PS2561D-1Y-A	Pb-Free and Halogen Free	Magazine case 100 pcs	Standard products (UL, CSA, BSI, SEMKO, NEMKO, FIMKO, DEMKO, CQC approved)	PS2561D-1	
PS2561DL-1	PS2561DL-1Y-A				PS2561DL-1	
PS2561DL1-1	PS2561DL1-1Y-A				PS2561DL1-1	
PS2561DL2-1	PS2561DL2-1Y-A				PS2561DL2-1	
PS2561DL-1-F3	PS2561DL-1Y-F3-A		Embossed Tape 2 000 pcs/reel		PS2561DL-1	
PS2561DL2-1-F3	PS2561DL2-1Y-F3-A		Embossed Tape 2 000 pcs/reel		PS2561DL2-1	
PS2561D-1-V	PS2561D-1Y-V-A		Magazine case 100 pcs	UL, CSA, BSI, SEMKO, NEMKO, FIMKO, DEMKO, CQC, DIN EN 60747-5-5 approved	PS2561D-1	
PS2561DL-1-V	PS2561DL-1Y-V-A				PS2561DL-1	
PS2561DL1-1-V	PS2561DL1-1Y-V-A				PS2561DL1-1	
PS2561DL2-1-V	PS2561DL2-1Y-V-A				PS2561DL2-1	
PS2561DL-1-V-F3	PS2561DL-1Y-V-F3-A				Embossed Tape 2 000 pcs/reel	PS2561DL-1
PS2561DL2-1-V-F3	PS2561DL2-1Y-V-F3-A				Embossed Tape 2 000 pcs/reel	PS2561DL2-1

Notes: \*1. When specifying CTR rank, please add "/CTR rank" after Order Number.

ex. L rank : PS2561D-1Y-A/L

Notes: \*2. For the application of the Safety Standard, following part number should be used.

**ABSOLUTE MAXIMUM RATINGS (T<sub>A</sub> = 25°C, unless otherwise specified)**

Parameter		Symbol	Ratings	Unit
Diode	Reverse Voltage	V <sub>R</sub>	6	V
	Forward Current (DC)	I <sub>F</sub>	40	mA
	Power Dissipation Derating	ΔP <sub>D</sub> /°C	1.5	mW/°C
	Power Dissipation	P <sub>D</sub>	150	mW
	Peak Forward Current*1	I <sub>FP</sub>	1	A
Transistor	Collector to Emitter Voltage	V <sub>CEO</sub>	80	V
	Emitter to Collector Voltage	V <sub>ECO</sub>	7	V
	Collector Current	I <sub>C</sub>	50	mA
	Power Dissipation Derating	ΔP <sub>C</sub> /°C	1.5	mW/°C
	Power Dissipation	P <sub>C</sub>	150	mW
Isolation Voltage*2		BV	5 000	Vr.m.s.
Operating Ambient Temperature		T <sub>A</sub>	-55 to +110	°C
Storage Temperature		T <sub>stg</sub>	-55 to +150	°C

Note: \*1. PW = 100 μs, Duty Cycle = 1%

\*2. AC voltage for 1 minute at T<sub>A</sub> = 25°C, RH = 60% between input and output.

Pins 1-2 shorted together, 3-4 shorted together.

**ELECTRICAL CHARACTERISTICS (T<sub>A</sub> = 25°C)**

Parameter		Symbol	Conditions	MIN.	TYP.	MAX.	Unit
Diode	Forward Voltage	V <sub>F</sub>	I <sub>F</sub> = 10 mA		1.2	1.4	V
	Reverse Current	I <sub>R</sub>	V <sub>R</sub> = 5 V			5	μA
	Terminal Capacitance	C <sub>t</sub>	V = 0 V, f = 1.0 MHz		10		pF
Transistor	Collector to Emitter Dark Current	I <sub>CEO</sub>	V <sub>CE</sub> = 48 V, I <sub>F</sub> = 0 mA			100	nA
Coupled	Current Transfer Ratio (I <sub>c</sub> /I <sub>F</sub> )*1	CTR	I <sub>F</sub> = 5 mA, V <sub>CE</sub> = 5 V	50	160	400	%
			I <sub>F</sub> = 1 mA, V <sub>CE</sub> = 5 V	10	80		
	Collector Saturation Voltage	V <sub>CE(sat)</sub>	I <sub>F</sub> = 10 mA, I <sub>c</sub> = 2 mA			0.3	V
	Isolation Resistance	R <sub>I-O</sub>	V <sub>I-O</sub> = 1.0 kV <sub>DC</sub>	10 <sup>11</sup>			Ω
	Isolation Capacitance	C <sub>I-O</sub>	V = 0 V, f = 1.0 MHz		0.5		pF
	Rise Time*2	t <sub>r</sub>	V <sub>CC</sub> = 10 V, I <sub>c</sub> = 2 mA, R <sub>L</sub> = 100 Ω		3		μs
	Fall Time*2	t <sub>f</sub>			5		

Note: \*1. CTR rank

CTR Rank	CTR (%)	Conditions
H	80 to 160	I <sub>F</sub> = 5 mA, V <sub>CE</sub> = 5 V
	16 and larger	I <sub>F</sub> = 1 mA, V <sub>CE</sub> = 5 V
Q	100 to 200	I <sub>F</sub> = 5 mA, V <sub>CE</sub> = 5 V
	20 and larger	I <sub>F</sub> = 1 mA, V <sub>CE</sub> = 5 V
W	130 to 260	I <sub>F</sub> = 5 mA, V <sub>CE</sub> = 5 V
	26 and larger	I <sub>F</sub> = 1 mA, V <sub>CE</sub> = 5 V
L	200 to 400	I <sub>F</sub> = 5 mA, V <sub>CE</sub> = 5 V
	40 and larger	I <sub>F</sub> = 1 mA, V <sub>CE</sub> = 5 V
N	50 to 400	I <sub>F</sub> = 5 mA, V <sub>CE</sub> = 5 V
	10 and larger	I <sub>F</sub> = 1 mA, V <sub>CE</sub> = 5 V

\*2. Test Circuit for Switching Time

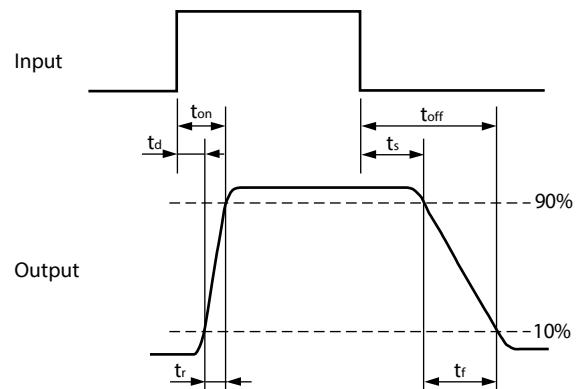
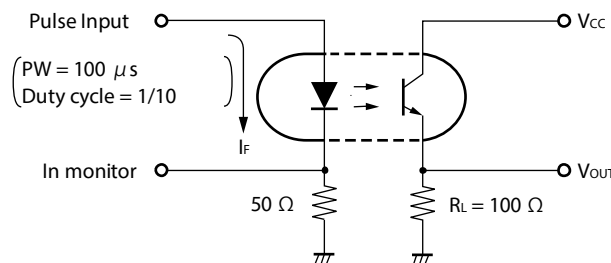

**TYPICAL CHARACTERISTICS ( $T_A = 25^\circ\text{C}$ , unless otherwise specified)**



**Remark** The graphs indicate nominal characteristics.

NORMALIZED CURRENT TRANSFER RATIO vs. AMBIENT TEMPERATURE



CURRENT TRANSFER RATIO vs. FORWARD CURRENT

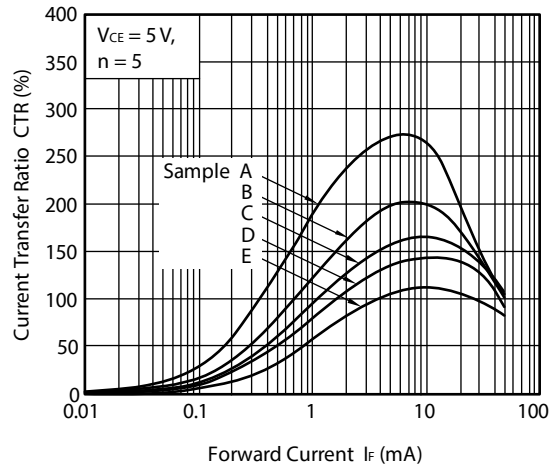

SWITCHING TIME vs. LOAD RESISTANCE

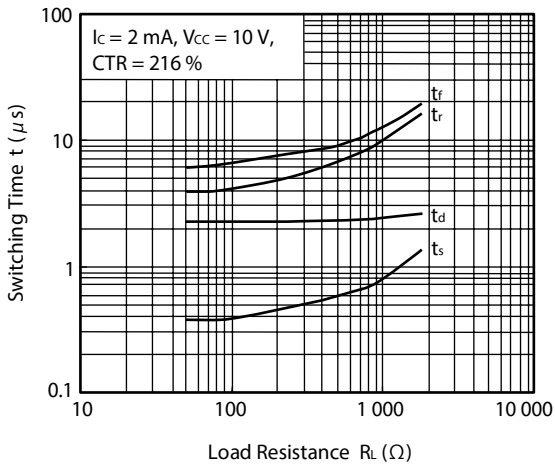

SWITCHING TIME vs. LOAD RESISTANCE

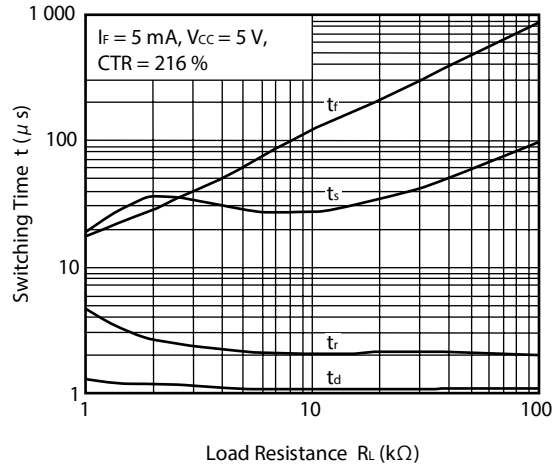

FREQUENCY RESPONSE



**Remark** The graphs indicate nominal characteristics.

**TAPING SPECIFICATIONS (UNIT: mm)**

Taping Direction

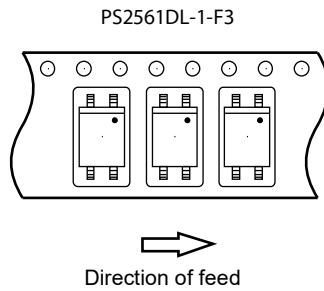

Outline and Dimensions (Tape)



Outline and Dimensions (Reel)



Packing: 2 000 pcs/reel



**TAPING SPECIFICATIONS (UNIT: mm)**

Taping Direction



Outline and Dimensions (Tape)



Outline and Dimensions (Reel)



**RECOMMENDED MOUNT PAD DIMENSIONS (UNIT: mm)**



Part Number	Lead Bending	A	B	C	D
PS2561DL	lead bending type (Gull-wing) for long creepage distance (surface mount)	8.2	2.54	1.7	2.2
PS2561DL2	lead bending type (Gull-wing) for surface mount	10.2	2.54	1.7	2.2

**Remark** All dimensions in this figure must be evaluated before use.

## NOTES ON HANDLING

### 1. Recommended soldering conditions

#### (1) Infrared reflow soldering

- |   |   |
|---|---|
| • Peak reflow temperature                       | 260°C or below (package surface temperature)  |
| • Time of peak reflow temperature               | 10 seconds or less  |
| • Time of temperature higher than 220°C         | 60 seconds or less  |
| • Time to preheat temperature from 120 to 180°C | 120±30 s  |
| • Number of reflows                             | Three   |
| • Flux  | Rosin flux containing small amount of chlorine<br>(The flux with a maximum chlorine content of 0.2 Wt% is recommended.) |

Recommended Temperature Profile of Infrared Reflow



#### (2) Wave soldering

- |                         |  |
|-------------------------|--|
| • Temperature           | 260°C or below (molten solder temperature)   |
| • Time                  | 10 seconds or less   |
| • Preheating conditions | 120°C or below (package surface temperature)   |
| • Number of times       | One (Allowed to be dipped in solder including plastic mold portion.)   |
| • Flux                  | Rosin flux containing small amount of chlorine (The flux with a maximum chlorine content of 0.2 Wt% is recommended.) |

#### (3) Soldering by Soldering Iron

- |  |   |
|--|---|
| • Peak Temperature (lead part temperature) | 350°C or below  |
| • Time (each pins)                         | 3 seconds or less   |
| • Flux                                     | Rosin flux containing small amount of chlorine<br>(The flux with a maximum chlorine content of 0.2 Wt% is recommended.) |

(a) Soldering of leads should be made at the point 1.5 to 2.0 mm from the root of the lead

(b) Please be sure that the temperature of the package would not be heated over 100°C

#### (4) Cautions

- Flux Cleaning  
Avoid cleaning with Freon based or halogen-based (chlorinated etc.) solvents.
- Do not use fixing agents or coatings containing halogen-based substances.

2. Cautions regarding noise

Be aware that when voltage is applied suddenly between the photocoupler's input and output or between collector-emitters at startup, the output transistor may enter the on state, even if the voltage is within the absolute maximum ratings.

3. Measurement conditions of current transfer ratios (CTR), which differ according to photocoupler

Check the setting values before use, since the forward current conditions at CTR measurement differ according to product.

When using products other than at the specified forward current, the characteristics curves may differ from the standard curves due to CTR value variations or the like. Therefore, check the characteristics under the actual operating conditions and thoroughly take variations or the like into consideration before use.

## **USAGE CAUTIONS**

1. Protect against static electricity when handling.
2. Avoid storage at a high temperature and high humidity.
3. Avoid cleaning with Freon based or halogen-based (chlorinated etc.) solvents.
4. Do not use fixing agents or coatings containing halogen-based substances.

**SPECIFICATION OF VDE MARKS LICENSE DOCUMENT (1/2)  
(PS2561D-1, PS2561DL-1)**

Parameter	Symbol	Rating	Unit
Climatic test class (IEC 60068-1/DIN EN 60068-1)		55/110/21	
Dielectric strength maximum operating isolation voltage Test voltage (partial discharge test, procedure a for type test and random test) $U_{pr} = 1.6 \times U_{IORM}, P_d < 5 \text{ pC}$	$U_{IORM}$ $U_{pr}$	890 1 424	$V_{peak}$ $V_{peak}$
Test voltage (partial discharge test, procedure b for all devices) $U_{pr} = 1.875 \times U_{IORM}, P_d < 5 \text{ pC}$	$U_{pr}$	1 669	$V_{peak}$
Highest permissible overvoltage	$U_{IOTM}$	8 000	$V_{peak}$
Degree of pollution (IEC 60664-1/DIN EN 60664-1 (VDE 0110-1))		2	
Comparative tracking index (IEC 60112/DIN EN 60112 (VDE 0303-11))	CTI	175	
Material group (IEC 60664-1/DIN EN 60664-1 (VDE 0110-1))		III a	
Storage temperature range	$T_{stg}$	-55 to +150	°C
Operating temperature range	$T_A$	-55 to +110	°C
Isolation resistance, minimum value $V_{IO} = 500 \text{ V dc at } T_A = 25^\circ\text{C}$ $V_{IO} = 500 \text{ V dc at } T_A \text{ MAX. at least } 100^\circ\text{C}$	$R_{is \text{ MIN.}}$ $R_{is \text{ MIN.}}$	$10^{12}$ $10^{11}$	$\Omega$ $\Omega$
Safety maximum ratings (maximum permissible in case of fault, see thermal derating curve) Package temperature Current (input current $I_F$ , $P_{si} = 0$ ) Power (output or total power dissipation) Isolation resistance $V_{IO} = 500 \text{ V dc at } T_A = T_{si}$	$T_{si}$ $I_{si}$ $P_{si}$ $R_{is \text{ MIN.}}$	175 400 700 $10^9$	°C mA mW $\Omega$

Dependence of maximum safety ratings with package temperature

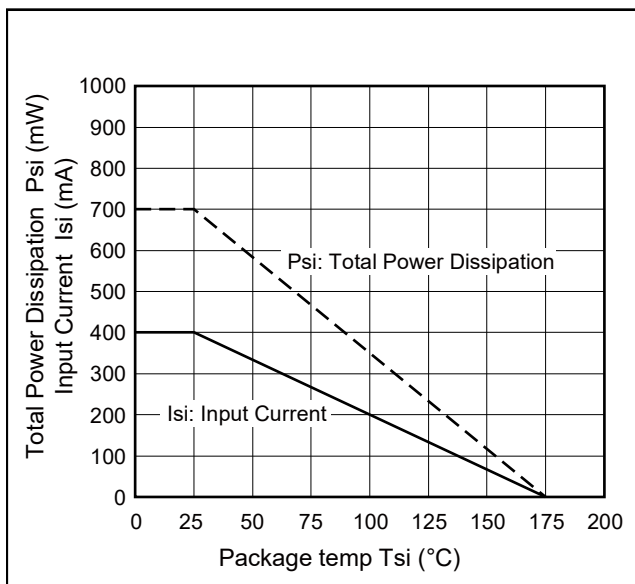

**SPECIFICATION OF VDE MARKS LICENSE DOCUMENT (2/2)  
(PS2561DL1-1, PS2561DL2-1)**

Parameter	Symbol	Rating	Unit
Climatic test class (IEC 60068-1/DIN EN 60068-1)		55/110/21	
Dielectric strength maximum operating isolation voltage Test voltage (partial discharge test, procedure a for type test and random test) $U_{pr} = 1.6 \times U_{IORM}, P_d < 5 \text{ pC}$	$U_{IORM}$ $U_{pr}$	1 130 1 808	$V_{peak}$ $V_{peak}$
Test voltage (partial discharge test, procedure b for all devices) $U_{pr} = 1.875 \times U_{IORM}, P_d < 5 \text{ pC}$	$U_{pr}$	2 119	$V_{peak}$
Highest permissible overvoltage	$U_{IOTM}$	8 000	$V_{peak}$
Degree of pollution (IEC 60664-1/DIN EN 60664-1 (VDE 0110-1))		2	
Comparative tracking index (IEC 60112/DIN EN 60112 (VDE 0303-11))	CTI	175	
Material group (IEC 60664-1/DIN EN 60664-1 (VDE 0110-1))		III a	
Storage temperature range	$T_{stg}$	-55 to +150	°C
Operating temperature range	$T_A$	-55 to +110	°C
Isolation resistance, minimum value $V_{IO} = 500 \text{ V dc at } T_A = 25^\circ\text{C}$ $V_{IO} = 500 \text{ V dc at } T_A \text{ MAX. at least } 100^\circ\text{C}$	$R_{is \text{ MIN.}}$ $R_{is \text{ MIN.}}$	$10^{12}$ $10^{11}$	$\Omega$ $\Omega$
Safety maximum ratings (maximum permissible in case of fault, see thermal derating curve) Package temperature Current (input current $I_F$ , $P_{si} = 0$ ) Power (output or total power dissipation) Isolation resistance $V_{IO} = 500 \text{ V dc at } T_A = T_{si}$	$T_{si}$ $I_{si}$ $P_{si}$ $R_{is \text{ MIN.}}$	175 400 700 $10^9$	°C mA mW $\Omega$

Dependence of maximum safety ratings with package temperature



Method a) Destructive Test, Type and Sample Test (PS2561D-1, PS2561DL-1)

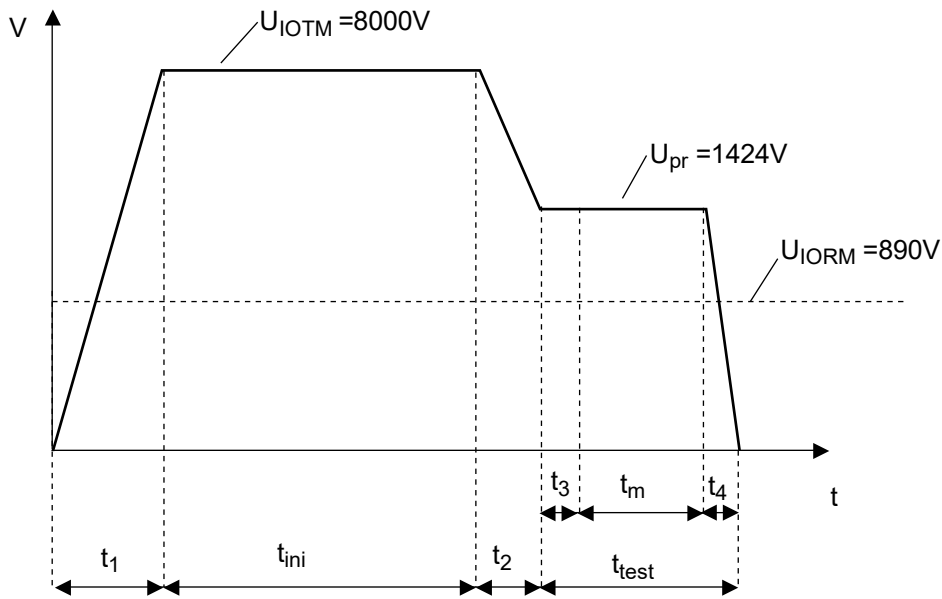

$t_1, t_2 = 1 \text{ to } 10 \text{ sec}$   
 $t_3, t_4 = 1 \text{ sec}$   
 $t_m(\text{PARTIAL DISCHARGE}) = 10 \text{ sec}$   
 $t_{\text{test}} = 12 \text{ sec}$   
 $t_{\text{ini}} = 60 \text{ sec}$

Method b) Non-destructive Test, 100% Production Test (PS2561D-1, PS2561DL-1)

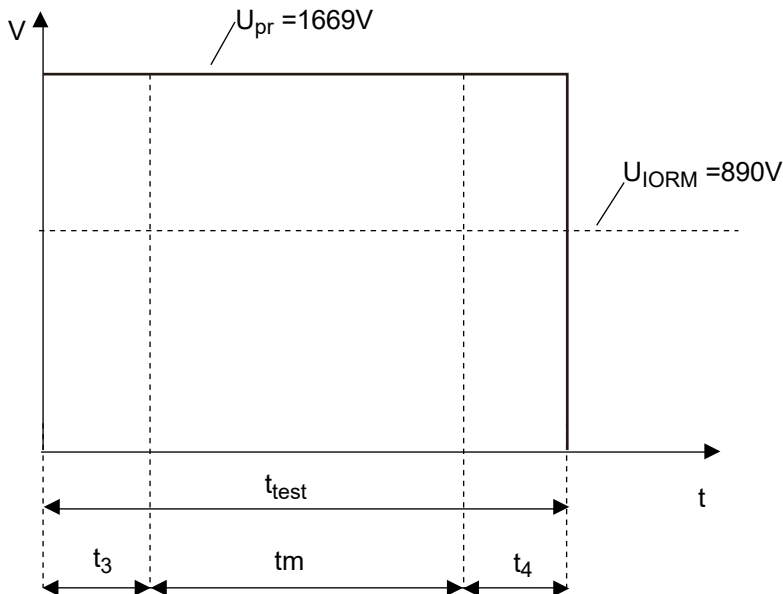

$t_3, t_4 = 0.1 \text{ sec}$   
 $t_m(\text{PARTIAL DISCHARGE}) = 1.0 \text{ sec}$   
 $t_{\text{test}} = 1.2 \text{ sec}$

Method a) Destructive Test, Type and Sample Test (PS2561DL1-1, PS2561DL2-1)



$t_1, t_2 = 1 \text{ to } 10 \text{ sec}$   
 $t_3, t_4 = 1 \text{ sec}$   
 $t_m(\text{PARTIAL DISCHARGE}) = 10 \text{ sec}$   
 $t_{\text{test}} = 12 \text{ sec}$   
 $t_{\text{ini}} = 60 \text{ sec}$

Method b) Non-destructive Test, 100% Production Test (PS2561DL1-1, PS2561DL2-1)



$t_3, t_4 = 0.1 \text{ sec}$   
 $t_m(\text{PARTIAL DISCHARGE}) = 1.0 \text{ sec}$   
 $t_{\text{test}} = 1.2 \text{ sec}$



<b>Caution</b>	GaAs Products	<p>This product uses gallium arsenide (GaAs). GaAs vapor and powder are hazardous to human health if inhaled or ingested, so please observe the following points.</p> <ul style="list-style-type: none"><li>• Follow related laws and ordinances when disposing of the product. If there are no applicable laws and/or ordinances, dispose of the product as recommended below.<ol style="list-style-type: none"><li>1. Commission a disposal company able to (with a license to) collect, transport and dispose of materials that contain arsenic and other such industrial waste materials.</li><li>2. Exclude the product from general industrial waste and household garbage, and ensure that the product is controlled (as industrial waste subject to special control) up until final disposal.</li></ol></li><li>• Do not burn, destroy, cut, crush, or chemically dissolve the product.</li><li>• Do not lick the product or in any way allow it to enter the mouth.</li></ul>
----------------	---------------	--

All trademarks and registered trademarks are the property of their respective owners.

## Notice

1. Descriptions of circuits, software and other related information in this document are provided only to illustrate the operation of semiconductor products and application examples. You are fully responsible for the incorporation or any other use of the circuits, software, and information in the design of your product or system. Renesas Electronics disclaims any and all liability for any losses and damages incurred by you or third parties arising from the use of these circuits, software, or information.
2. Renesas Electronics hereby expressly disclaims any warranties against and liability for infringement or any other claims involving patents, copyrights, or other intellectual property rights of third parties, by or arising from the use of Renesas Electronics products or technical information described in this document, including but not limited to, the product data, drawings, charts, programs, algorithms, and application examples.
3. No license, express, implied or otherwise, is granted hereby under any patents, copyrights or other intellectual property rights of Renesas Electronics or others.
4. You shall not alter, modify, copy, or reverse engineer any Renesas Electronics product, whether in whole or in part. Renesas Electronics disclaims any and all liability for any losses or damages incurred by you or third parties arising from such alteration, modification, copying or reverse engineering.
5. Renesas Electronics products are classified according to the following two quality grades: "Standard" and "High Quality". The intended applications for each Renesas Electronics product depends on the product's quality grade, as indicated below.  
"Standard": Computers; office equipment; communications equipment; test and measurement equipment; audio and visual equipment; home electronic appliances; machine tools; personal electronic equipment; industrial robots; etc.  
"High Quality": Transportation equipment (automobiles, trains, ships, etc.); traffic control (traffic lights); large-scale communication equipment; key financial terminal systems; safety control equipment; etc.  
Unless expressly designated as a high reliability product or a product for harsh environments in a Renesas Electronics data sheet or other Renesas Electronics document, Renesas Electronics products are not intended or authorized for use in products or systems that may pose a direct threat to human life or bodily injury (artificial life support devices or systems; surgical implantations; etc.), or may cause serious property damage (space system; undersea repeaters; nuclear power control systems; aircraft control systems; key plant systems; military equipment; etc.). Renesas Electronics disclaims any and all liability for any damages or losses incurred by you or any third parties arising from the use of any Renesas Electronics product that is inconsistent with any Renesas Electronics data sheet, user's manual or other Renesas Electronics document.
6. When using Renesas Electronics products, refer to the latest product information (data sheets, user's manuals, application notes, "General Notes for Handling and Using Semiconductor Devices" in the reliability handbook, etc.), and ensure that usage conditions are within the ranges specified by Renesas Electronics with respect to maximum ratings, operating power supply voltage range, heat dissipation characteristics, installation, etc. Renesas Electronics disclaims any and all liability for any malfunctions, failure or accident arising out of the use of Renesas Electronics products outside of such specified ranges.
7. Although Renesas Electronics endeavors to improve the quality and reliability of Renesas Electronics products, semiconductor products have specific characteristics, such as the occurrence of failure at a certain rate and malfunctions under certain use conditions. Unless designated as a high reliability product or a product for harsh environments in a Renesas Electronics data sheet or other Renesas Electronics document, Renesas Electronics products are not subject to radiation resistance design. You are responsible for implementing safety measures to guard against the possibility of bodily injury, injury or damage caused by fire, and/or danger to the public in the event of a failure or malfunction of Renesas Electronics products, such as safety design for hardware and software, including but not limited to redundancy, fire control and malfunction prevention, appropriate treatment for aging degradation or any other appropriate measures. Because the evaluation of microcomputer software alone is very difficult and impractical, you are responsible for evaluating the safety of the final products or systems manufactured by you.
8. Please contact a Renesas Electronics sales office for details as to environmental matters such as the environmental compatibility of each Renesas Electronics product. You are responsible for carefully and sufficiently investigating applicable laws and regulations that regulate the inclusion or use of controlled substances, including without limitation, the EU RoHS Directive, and using Renesas Electronics products in compliance with all these applicable laws and regulations. Renesas Electronics disclaims any and all liability for damages or losses occurring as a result of your noncompliance with applicable laws and regulations.
9. Renesas Electronics products and technologies shall not be used for or incorporated into any products or systems whose manufacture, use, or sale is prohibited under any applicable domestic or foreign laws or regulations. You shall comply with any applicable export control laws and regulations promulgated and administered by the governments of any countries asserting jurisdiction over the parties or transactions.
10. It is the responsibility of the buyer or distributor of Renesas Electronics products, or any other party who distributes, disposes of, or otherwise sells or transfers the product to a third party, to notify such third party in advance of the contents and conditions set forth in this document.
11. This document shall not be reprinted, reproduced or duplicated in any form, in whole or in part, without prior written consent of Renesas Electronics.
12. Please contact a Renesas Electronics sales office if you have any questions regarding the information contained in this document or Renesas Electronics products.  
(Note 1) "Renesas Electronics" as used in this document means Renesas Electronics Corporation and also includes its directly or indirectly controlled subsidiaries.  
(Note 2) "Renesas Electronics product(s)" means any product developed or manufactured by or for Renesas Electronics.

(Rev.4.0-1 November 2017)



### SALES OFFICES

Renesas Electronics Corporation

<http://www.renesas.com>

Refer to "<http://www.renesas.com/>" for the latest and detailed information.

**Renesas Electronics Corporation**  
TOYOSU FORESIA, 3-2-24 Toyosu, Koto-ku, Tokyo 135-0061, Japan

**Renesas Electronics America Inc.**  
1001 Murphy Ranch Road, Milpitas, CA 95035, U.S.A.  
Tel: +1-408-432-8888, Fax: +1-408-434-5351

**Renesas Electronics Canada Limited**  
9251 Yonge Street, Suite 8309 Richmond Hill, Ontario Canada L4C 9T3  
Tel: +1-905-237-2004

**Renesas Electronics Europe GmbH**  
Arcadiastrasse 10, 40472 Düsseldorf, Germany  
Tel: +49-211-6503-0, Fax: +49-211-6503-1327

**Renesas Electronics (China) Co., Ltd.**  
Room 101-T01, Floor 1, Building 7, Yard No. 7, 8th Street, Shangdi, Haidian District, Beijing 100085, China  
Tel: +86-10-8235-1155, Fax: +86-10-8235-7679

**Renesas Electronics (Shanghai) Co., Ltd.**  
Unit 301, Tower A, Central Towers, 555 Langao Road, Putuo District, Shanghai 200333, China  
Tel: +86-21-2226-0888, Fax: +86-21-2226-0999

**Renesas Electronics Hong Kong Limited**  
Unit 1601-1611, 16/F., Tower 2, Grand Century Place, 193 Prince Edward Road West, Mongkok, Kowloon, Hong Kong  
Tel: +852-2265-6688, Fax: +852 2886-9022

**Renesas Electronics Taiwan Co., Ltd.**  
13F, No. 363, Fu Shing North Road, Taipei 10543, Taiwan  
Tel: +886-2-8175-9600, Fax: +886 2-8175-9670

**Renesas Electronics Singapore Pte. Ltd.**  
80 Bendemeer Road, Unit #06-02 Hyflux Innovation Centre, Singapore 339949  
Tel: +65-6213-0200, Fax: +65-6213-0300

**Renesas Electronics Malaysia Sdn.Bhd.**  
Unit No 3A-1 Level 3A Tower 8 UOA Business Park, No 1 Jalan Pengaturcara U1/51A, Seksyen U1, 40150 Shah Alam, Selangor, Malaysia  
Tel: +60-3-5022-1288, Fax: +60-3-5022-1290

**Renesas Electronics India Pvt. Ltd.**  
No.777C, 100 Feet Road, HAL 2nd Stage, Indiranagar, Bangalore 560 038, India  
Tel: +91-80-67208700

**Renesas Electronics Korea Co., Ltd.**  
17F, KAMCO Yangjae Tower, 262, Gangnam-daero, Gangnam-gu, Seoul, 06265 Korea  
Tel: +82-2-558-3737, Fax: +82-2-558-5338

Компания «Life Electronics» занимается поставками электронных компонентов импортного и отечественного производства от производителей и со складов крупных дистрибьюторов Европы, Америки и Азии.

С конца 2013 года компания активно расширяет линейку поставок компонентов по направлению коаксиальный кабель, кварцевые генераторы и конденсаторы (керамические, пленочные, электролитические), за счёт заключения дистрибьюторских договоров

Мы предлагаем:

- Конкурентоспособные цены и скидки постоянным клиентам.
- Специальные условия для постоянных клиентов.
- Подбор аналогов.
- Поставку компонентов в любых объемах, удовлетворяющих вашим потребностям.
- Приемлемые сроки поставки, возможна ускоренная поставка.
- Доставку товара в любую точку России и стран СНГ.
- Комплексную поставку.
- Работу по проектам и поставку образцов.
- Формирование склада под заказчика.
- Сертификаты соответствия на поставляемую продукцию (по желанию клиента).
- Тестирование поставляемой продукции.
- Поставку компонентов, требующих военную и космическую приемку.
- Входной контроль качества.
- Наличие сертификата ISO.

В составе нашей компании организован Конструкторский отдел, призванный помогать разработчикам, и инженерам.

Конструкторский отдел помогает осуществить:

- Регистрацию проекта у производителя компонентов.
- Техническую поддержку проекта.
- Защиту от снятия компонента с производства.
- Оценку стоимости проекта по компонентам.
- Изготовление тестовой платы монтаж и пусконаладочные работы.



Тел: +7 (812) 336 43 04 (многоканальный)

Email: [org@lifeelectronics.ru](mailto:org@lifeelectronics.ru)