

RONDA-O-C

~50° + 30° oval beam with holder C compatible
with LEDiL HEKLA

TECHNICAL SPECIFICATIONS:

Dimensions	Ø 53.9 mm
Height	20.5 mm
Fastening	socket
ROHS compliant	yes ⓘ

MATERIAL SPECIFICATIONS:

Component	Type	Material	Colour	Finish
RONDA-O	Single lens	PMMA	clear	
RONDA-HLD-C	Holder	PC	white	



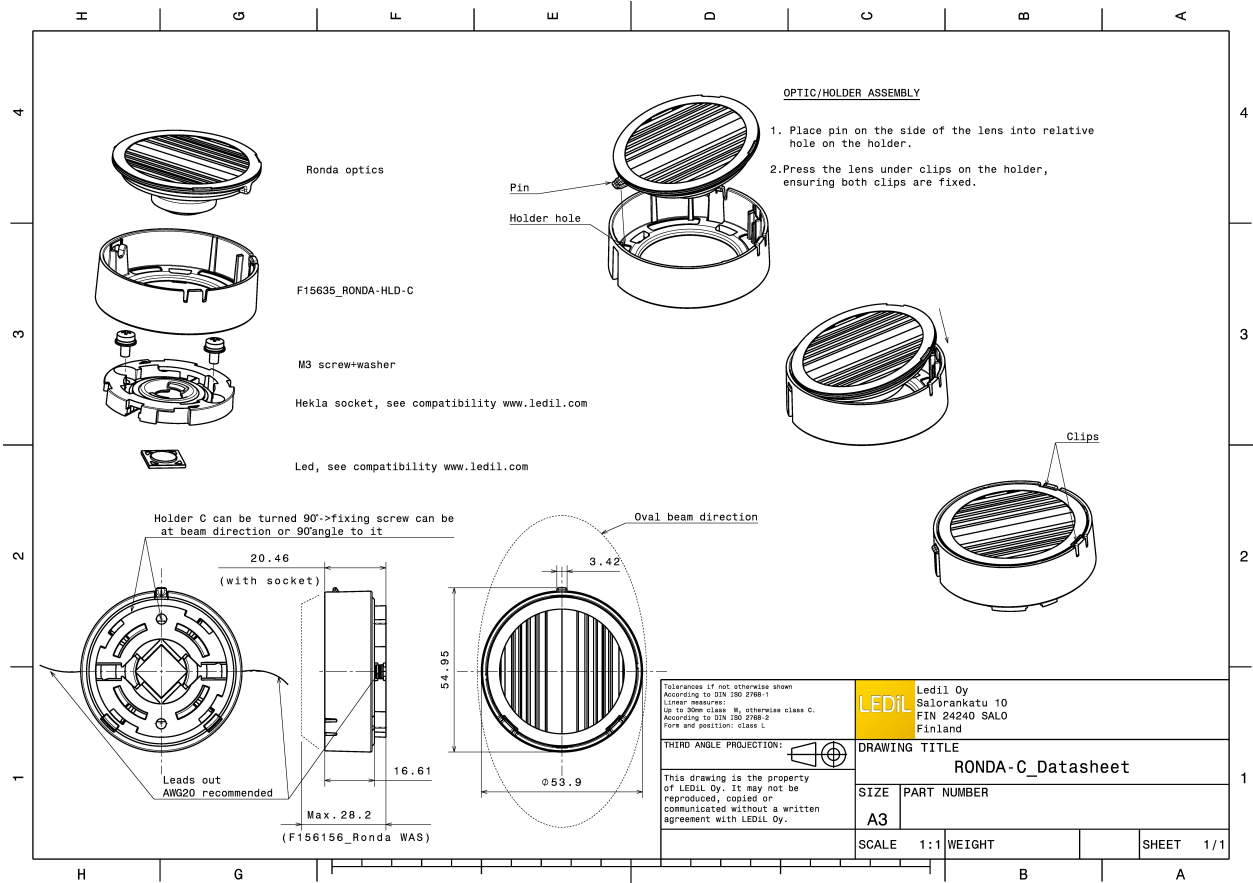

ORDERING INFORMATION:

Component		Qty in box	MOQ	MPQ	Box weight (kg)
FN15998_RONDA-O-C	Single lens	420	120	30	0.0
» Box size:					

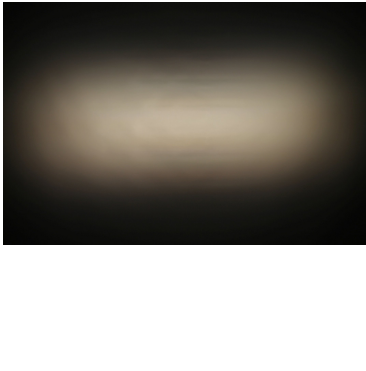
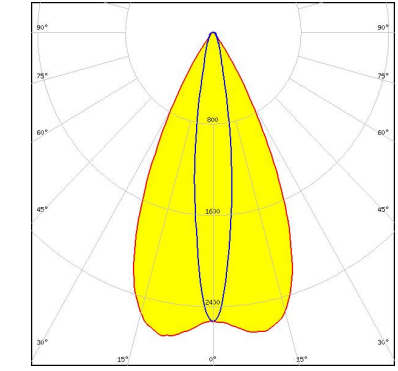
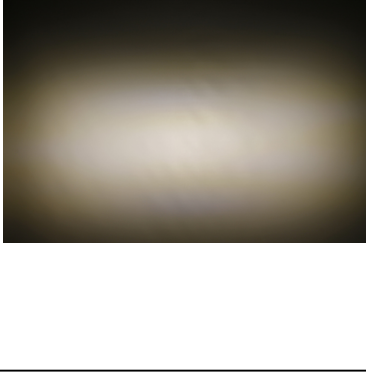
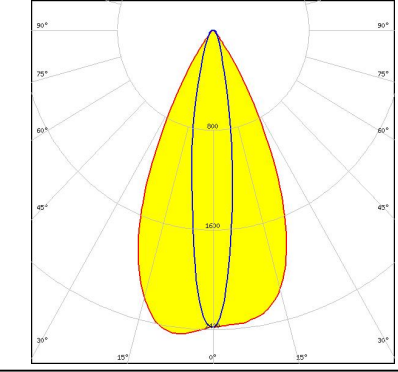
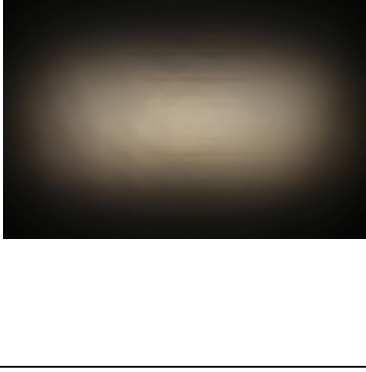
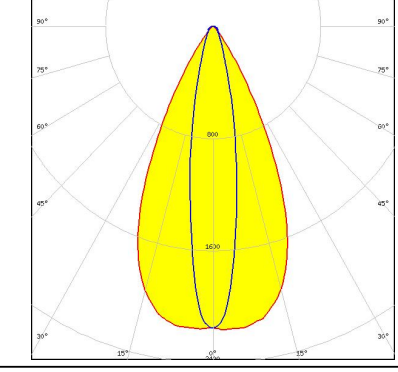

PHOTOMETRIC DATA (MEASURED):

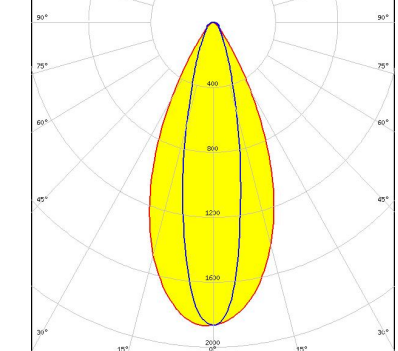
<p>bridgelux.</p> <p>LED V4 HD</p> <p>FWHM 51.0 + 16.0°</p> <p>Efficiency 92 %</p> <p>Peak intensity 2.7 cd/lm</p> <p>LEDs/each optic 1</p> <p>Light colour White</p> <p>Required components: F15253_HEKLA-SOCKET-A</p>		
<p>bridgelux.</p> <p>LED V6 Gen6</p> <p>FWHM 50.0 + 17.0°</p> <p>Efficiency 91 %</p> <p>Peak intensity 2.4 cd/lm</p> <p>LEDs/each optic 1</p> <p>Light colour White</p> <p>Required components: F15253_HEKLA-SOCKET-A</p>		
<p>bridgelux.</p> <p>LED V6 HD</p> <p>FWHM 51.0 + 19.0°</p> <p>Efficiency 91 %</p> <p>Peak intensity 2.2 cd/lm</p> <p>LEDs/each optic 1</p> <p>Light colour White</p> <p>Required components: F15255_HEKLA-SOCKET-C</p>		
<p>bridgelux.</p> <p>LED V9 HD</p> <p>FWHM 47.0 + 23.0°</p> <p>Efficiency 89 %</p> <p>Peak intensity 1.9 cd/lm</p> <p>LEDs/each optic 1</p> <p>Light colour White</p> <p>Required components: F15859_HEKLA-SOCKET-I</p>		

PHOTOMETRIC DATA (MEASURED):

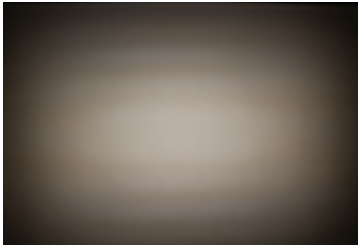
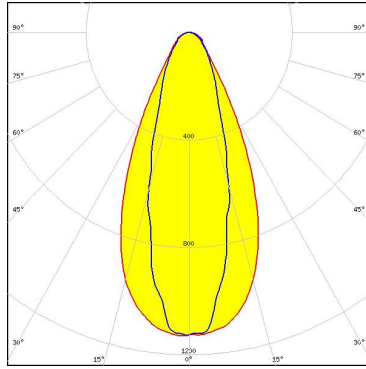
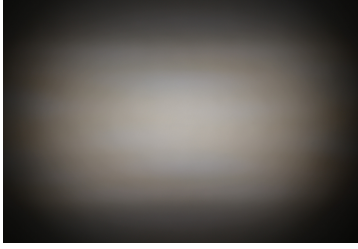
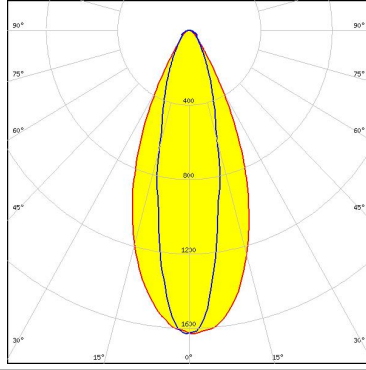
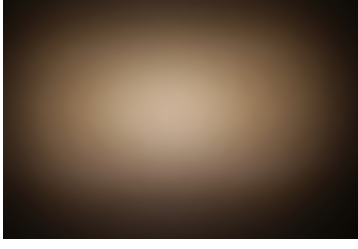
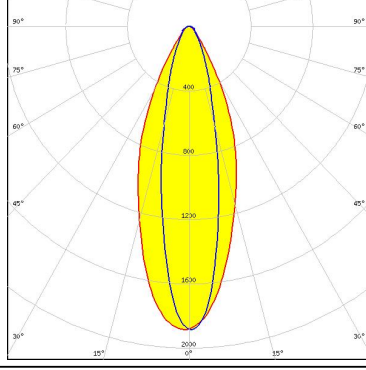
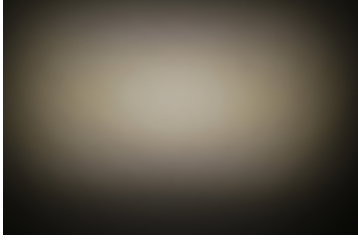
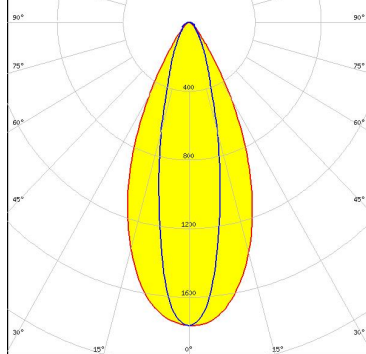
<p>bridgelux.</p> <p>LED Vesta TW 13mm (25W) CSP</p> <p>FWHM 50.0 + 31.0°</p> <p>Efficiency 82 %</p> <p>Peak intensity 1.1 cd/lm</p> <p>LEDs/each optic 1</p> <p>Light colour White</p> <p>Required components: C16142_HEKLA-SOCKET-K Bender Wirth: 492 Typ L8</p>		
<p>bridgelux.</p> <p>LED Vesta TW 9mm (12W) CSP</p> <p>FWHM 44.0 + 25.0°</p> <p>Efficiency 85 %</p> <p>Peak intensity 1.6 cd/lm</p> <p>LEDs/each optic 1</p> <p>Light colour White</p> <p>Required components: C16142_HEKLA-SOCKET-K</p>		
<p>CITIZEN</p> <p>LED CLC020 Series (Dim-To-Warm)</p> <p>FWHM 29.0 + 23.0°</p> <p>Efficiency 84 %</p> <p>Peak intensity 1.9 cd/lm</p> <p>LEDs/each optic 1</p> <p>Light colour White</p> <p>Required components: C16142_HEKLA-SOCKET-K</p>		
<p>CITIZEN</p> <p>LED CLL02x/CLU02x (LES10)</p> <p>FWHM 47.0 + 24.0°</p> <p>Efficiency 88 %</p> <p>Peak intensity 1.8 cd/lm</p> <p>LEDs/each optic 1</p> <p>Light colour White</p> <p>Required components: F15255_HEKLA-SOCKET-C</p>		

PHOTOMETRIC DATA (MEASURED):

CITIZEN

LED CLU700/701/702
 FWHM 50.0 + 18.0°
 Efficiency 90 %
 Peak intensity 2.3 cd/lm
 LEDs/each optic 1
 Light colour White
 Required components:
 F15255_HEKLA-SOCKET-C

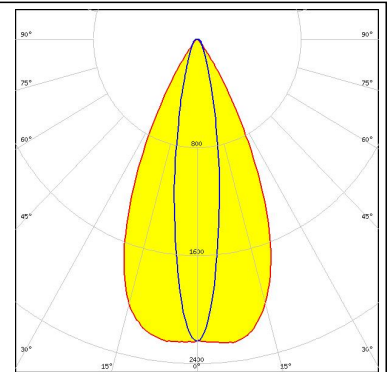
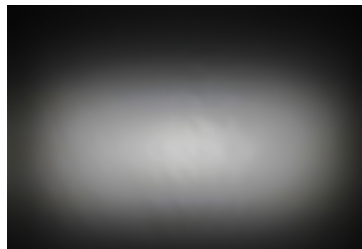

CITIZEN

LED CLU7A2 (LES 4.2mm)
 FWHM 49.0 + 14.0°
 Efficiency 91 %
 Peak intensity 3 cd/lm
 LEDs/each optic 1
 Light colour White
 Required components:
 F15255_HEKLA-SOCKET-C

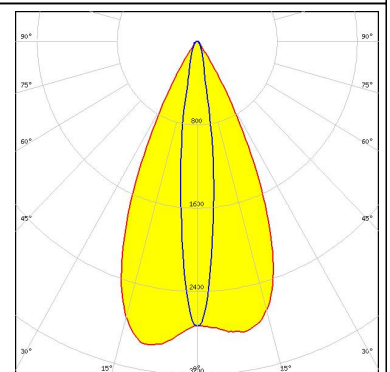
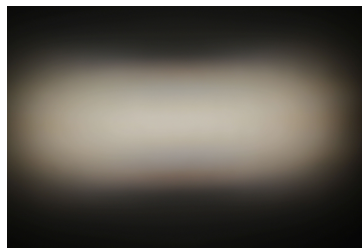

CREE

LED CMA1516
 FWHM 49.0 + 25.0°
 Efficiency 91 %
 Peak intensity 1.8 cd/lm
 LEDs/each optic 1
 Light colour White
 Required components:
 F15256_HEKLA-SOCKET-D

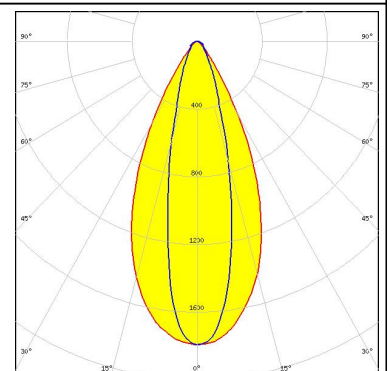
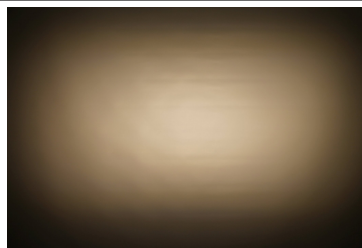

CREE

LED CMA1825
 FWHM 51.0 + 33.0°
 Efficiency 88 %
 Peak intensity 1.3 cd/lm
 LEDs/each optic 1
 Light colour White
 Required components:
 F15254_HEKLA-SOCKET-B

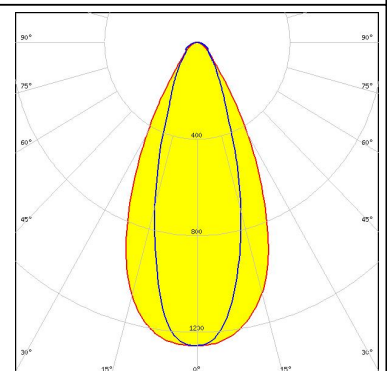
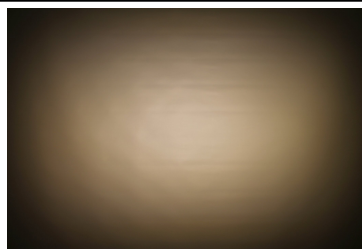

PHOTOMETRIC DATA (MEASURED):



LED CMT14xx
 FWHM 48.0 + 26.0°
 Efficiency 90 %
 Peak intensity 1.7 cd/lm
 LEDs/each optic 1
 Light colour White
 Required components:
 F15255_HEKLA-SOCKET-C

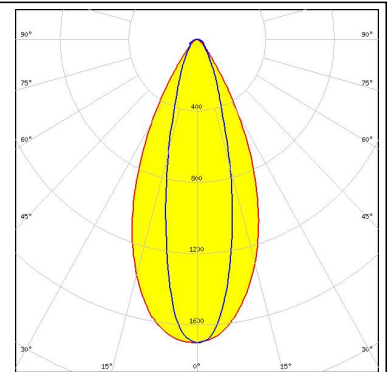
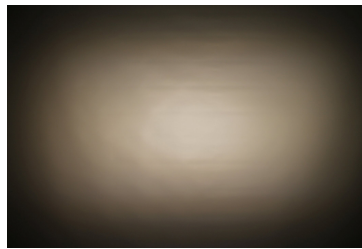

LED CMT19xx
 FWHM 54.0 + 38.0°
 Efficiency 84 %
 Peak intensity 1 cd/lm
 LEDs/each optic 1
 Light colour White
 Required components:
 F15859_HEKLA-SOCKET-I

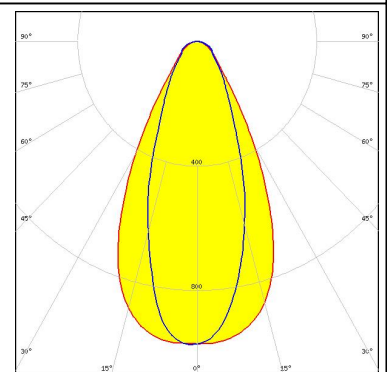
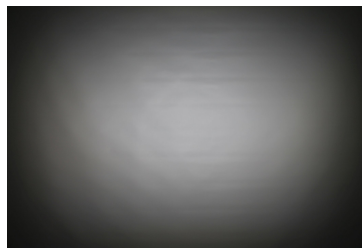

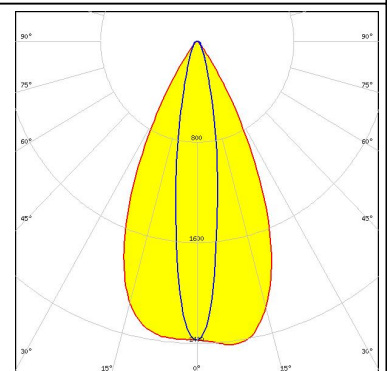
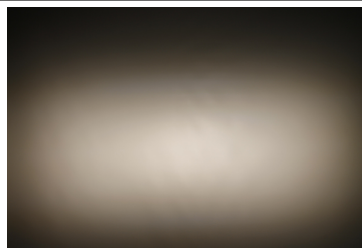

LED CXA/B 13xx
 FWHM 50.0 + 17.0°
 Efficiency 91 %
 Peak intensity 2.4 cd/lm
 LEDs/each optic 1
 Light colour White
 Required components:
 F15956_HEKLA-SOCKET-J

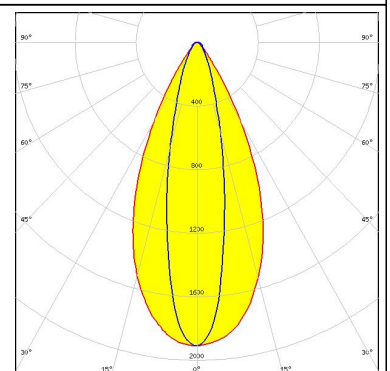
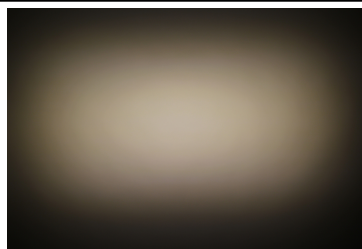

LED CXA/B 15xx
 FWHM 49.0 + 23.0°
 Efficiency 90 %
 Peak intensity 1.9 cd/lm
 LEDs/each optic 1
 Light colour White
 Required components:
 F15256_HEKLA-SOCKET-D



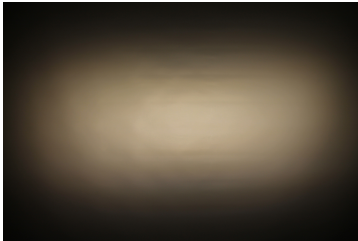
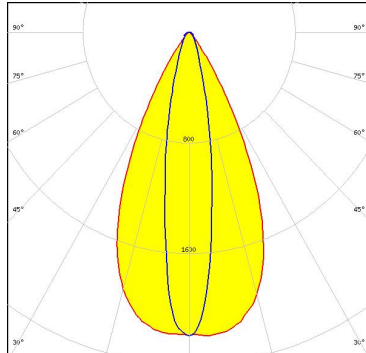
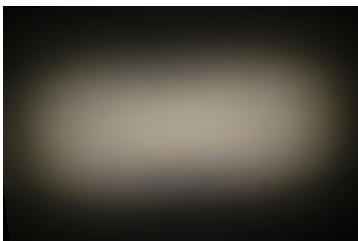
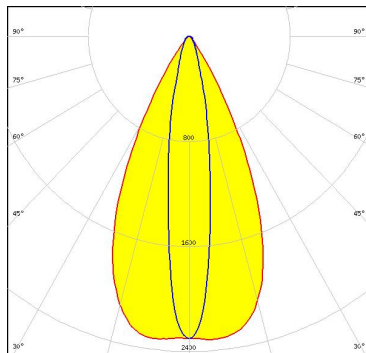
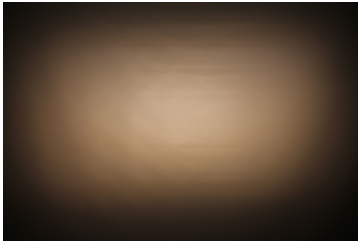
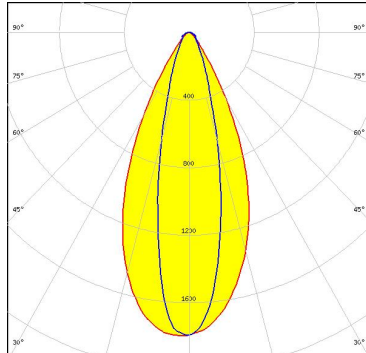

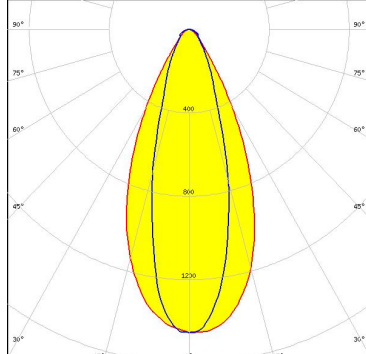
PHOTOMETRIC DATA (MEASURED):

<p>LUMILEDS</p> <p>LED LUXEON CoB 1202HD FWHM 51.0 + 18.0° Efficiency 91 % Peak intensity 2.2 cd/lm LEDs/each optic 1 Light colour White Required components: F15848_HEKLA-SOCKET-G</p>		
<p>LUMILEDS</p> <p>LED LUXEON CoB 1202s FWHM 51.0 + 17.0° Efficiency 91 % Peak intensity 2.3 cd/lm LEDs/each optic 1 Light colour White Required components: F15848_HEKLA-SOCKET-G</p>		
<p>LUMILEDS</p> <p>LED LUXEON CoB 1204HD FWHM 48.0 + 25.0° Efficiency 91 % Peak intensity 1.8 cd/lm LEDs/each optic 1 Light colour White Required components: F15858_HEKLA-SOCKET-H</p>		
<p>LUMILEDS</p> <p>LED LUXEON CoB 1205HD FWHM 48.0 + 30.0° Efficiency 88 % Peak intensity 1.5 cd/lm LEDs/each optic 1 Light colour White Required components: F15858_HEKLA-SOCKET-H</p>		

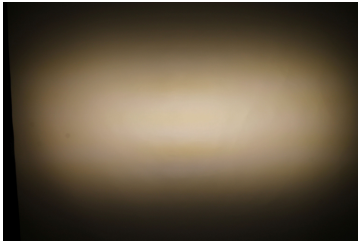
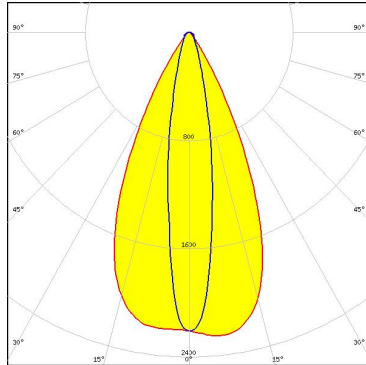
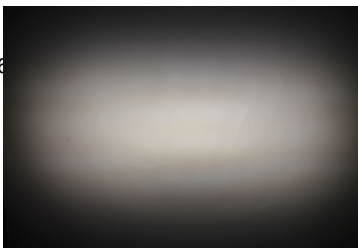
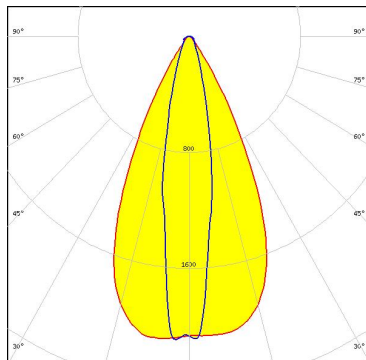
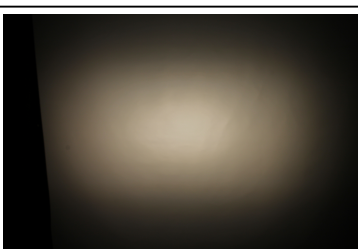
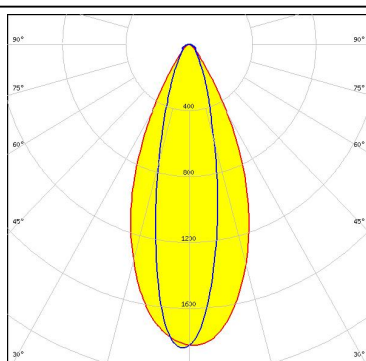
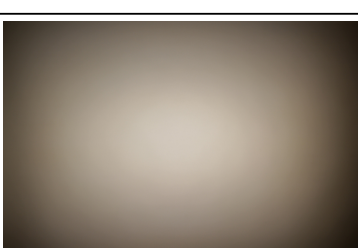
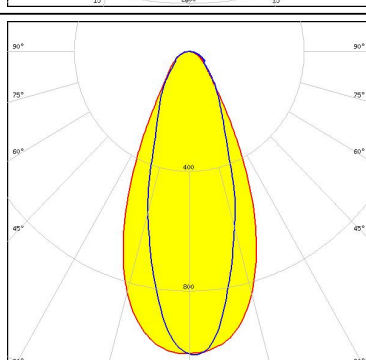
PHOTOMETRIC DATA (MEASURED):

<p>LUMILEDS</p> <p>LED LUXEON CX Plus CoB - HD S01H4</p> <p>FWHM 50.0 + 18.0°</p> <p>Efficiency 90 %</p> <p>Peak intensity 2.3 cd/lm</p> <p>LEDs/each optic 1</p> <p>Light colour White</p> <p>Required components: Bender Wirth: 634c Hekla</p>		
<p>LUMILEDS</p> <p>LED LUXEON CX Plus CoB - HD S01H6 / HD S02H6</p> <p>FWHM 51.0 + 20.0°</p> <p>Efficiency 91 %</p> <p>Peak intensity 2.1 cd/lm</p> <p>LEDs/each optic 1</p> <p>Light colour White</p> <p>Required components: Bender Wirth: 634c Hekla</p>		
<p>LUMILEDS</p> <p>LED LUXEON CX Plus CoB - HD S04H9</p> <p>FWHM 46.0 + 25.0°</p> <p>Efficiency 90 %</p> <p>Peak intensity 1.8 cd/lm</p> <p>LEDs/each optic 1</p> <p>Light colour White</p> <p>Required components: Bender Wirth: 634c Hekla</p>		
<p>LUMINUS</p> <p>LED CxM-14 (19x19)</p> <p>FWHM 49.0 + 35.0°</p> <p>Efficiency 79 %</p> <p>Peak intensity 1 cd/lm</p> <p>LEDs/each optic 1</p> <p>Light colour White</p> <p>Required components: F15859_HEKLA-SOCKET-I</p>		

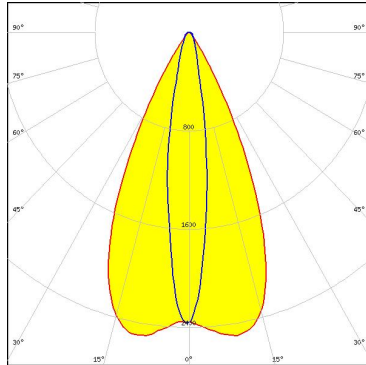
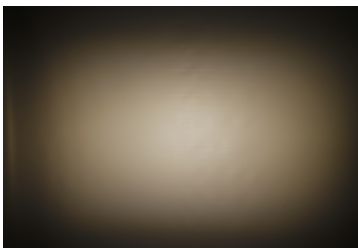
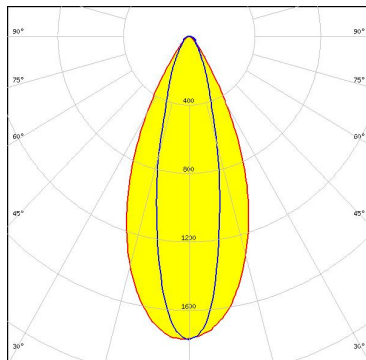
PHOTOMETRIC DATA (MEASURED):

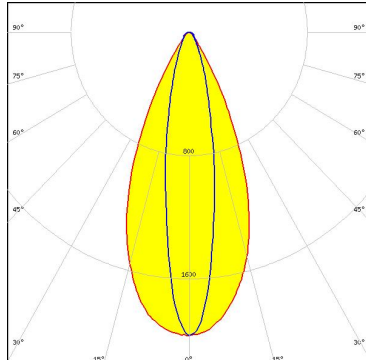
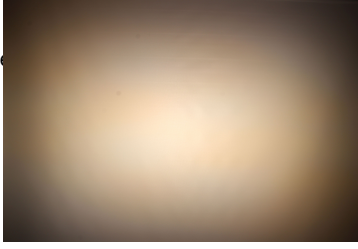
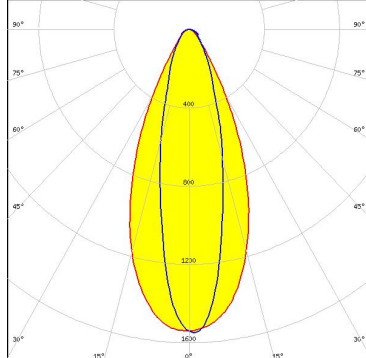
<p>LUMINUS</p> <p>LED CXM-4 FWHM 51.0 + 16.0° Efficiency 90 % Peak intensity 2.5 cd/lm LEDs/each optic 1 Light colour White Required components: F15255_HEKLA-SOCKET-C</p>		
<p>LUMINUS</p> <p>LED CxM-9 (13.5x13.5) FWHM 47.0 + 25.0° Efficiency 89 % Peak intensity 1.8 cd/lm LEDs/each optic 1 Light colour White Required components: F15255_HEKLA-SOCKET-C</p>		
<p>NICHIA</p> <p>LED NJCWL024Z-V1MT: COB L-Type Tunable White FWHM 46.0 + 20.0° Efficiency 82 % Peak intensity 1.9 cd/lm LEDs/each optic 1 Light colour White Required components: C16142_HEKLA-SOCKET-K Bender Wirth: 497 Typ L8</p>		
<p>NICHIA</p> <p>LED NVCWJ024Z-V1MT: COB J-Type Tunable White FWHM 45.0 + 25.0° Efficiency 84 % Peak intensity 1.6 cd/lm LEDs/each optic 1 Light colour White Required components: C16142_HEKLA-SOCKET-K Bender Wirth: 498 Typ L8</p>		

PHOTOMETRIC DATA (MEASURED):

PHILIPS

LED Fortimo SLM L09 CoB
 FWHM 48.0 + 25.0°
 Efficiency 90 %
 Peak intensity 1.7 cd/lm
 LEDs/each optic 1
 Light colour White
 Required components:
 F15858_HEKLA-SOCKET-H

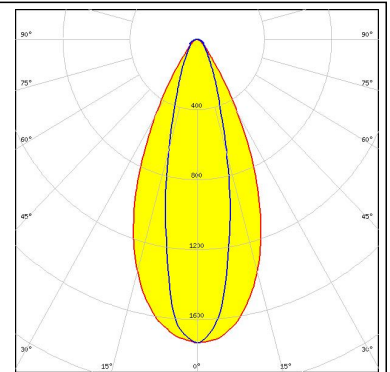
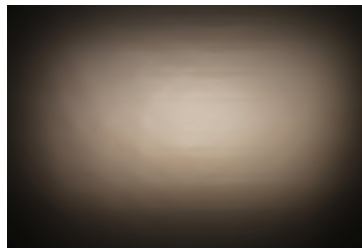

PHILIPS

LED Fortimo SLM L13 CoB
 FWHM 41.0 + 45.0°
 Efficiency 83 %
 Peak intensity 1 cd/lm
 LEDs/each optic 1
 Light colour White
 Required components:
 C16142_HEKLA-SOCKET-K
 Bender Wirth: 432 Typ L8

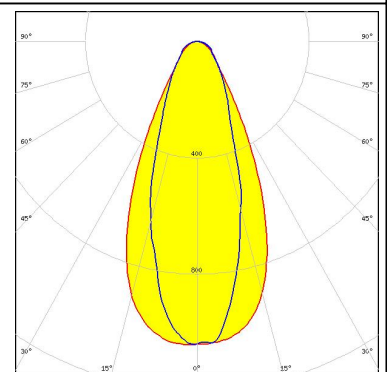
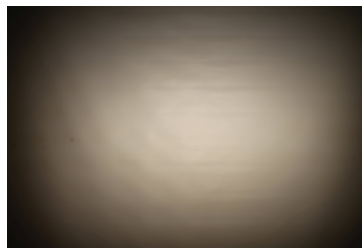

SAMSUNG

LED LC003D / LC006D / LC009D / LC013D
 FWHM 48.0 + 25.0°
 Efficiency 89 %
 Peak intensity 1.7 cd/lm
 LEDs/each optic 1
 Light colour White
 Required components:
 F15255_HEKLA-SOCKET-C

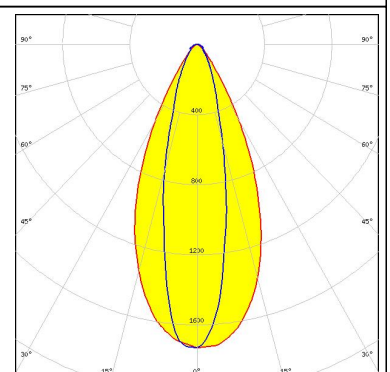
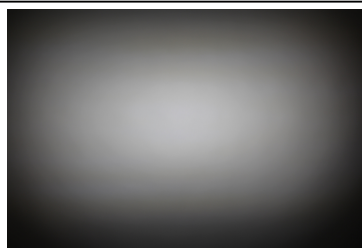

SAMSUNG

LED LC010C
 FWHM 52.0 + 18.0°
 Efficiency 90 %
 Peak intensity 2.1 cd/lm
 LEDs/each optic 1
 Light colour White
 Required components:
 F15848_HEKLA-SOCKET-G

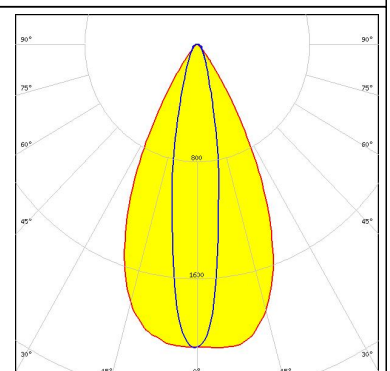
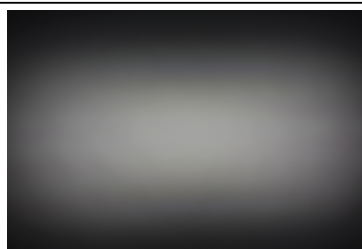

PHOTOMETRIC DATA (MEASURED):

SAMSUNG

LED LC010C G2
 FWHM 50.0 + 17.0°
 Efficiency 89 %
 Peak intensity 2.3 cd/lm
 LEDs/each optic 1
 Light colour White
 Required components:
 F15255_HEKLA-SOCKET-C

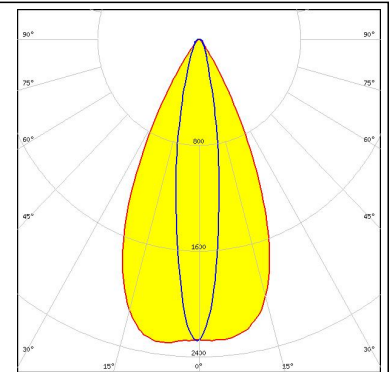
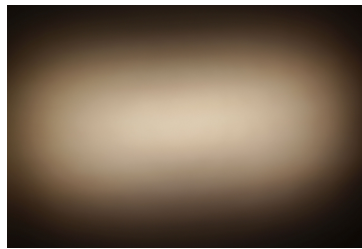

SAMSUNG

LED LC016D / LC019D / LC026D / LC033D
 FWHM 55.0 + 37.0°
 Efficiency 82 %
 Peak intensity 1 cd/lm
 LEDs/each optic 1
 Light colour White
 Required components:
 F15859_HEKLA-SOCKET-I

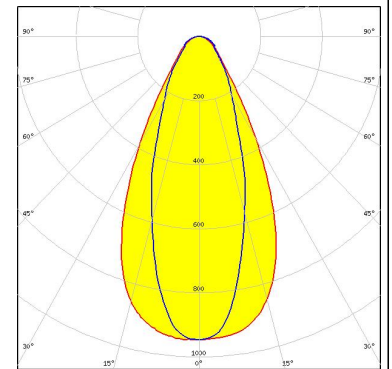
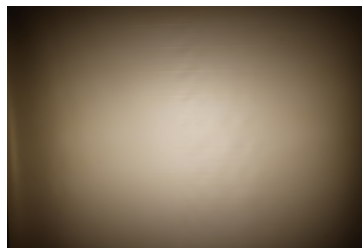

SAMSUNG

LED LC020C
 FWHM 49.0 + 22.0°
 Efficiency 90 %
 Peak intensity 1.9 cd/lm
 LEDs/each optic 1
 Light colour White
 Required components:
 F15848_HEKLA-SOCKET-G

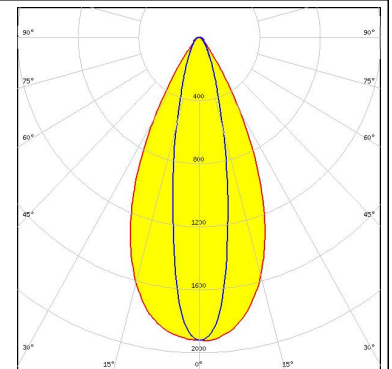
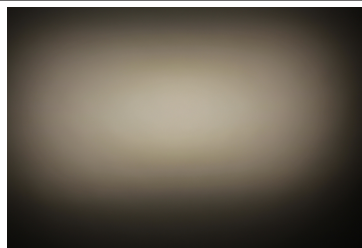

SAMSUNG

LED LC020C G2
 FWHM 47.0 + 23.0°
 Efficiency 88 %
 Peak intensity 1.9 cd/lm
 LEDs/each optic 1
 Light colour White
 Required components:
 F15859_HEKLA-SOCKET-I

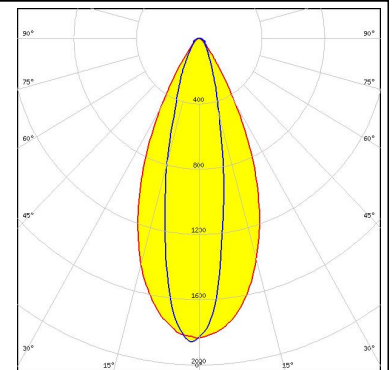
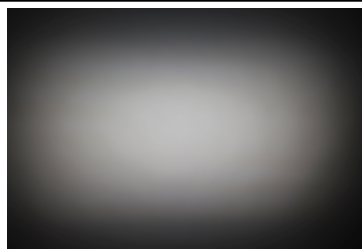

PHOTOMETRIC DATA (MEASURED):

TRIDONIC

LED SLE G7 LES09
 FWHM 46.0 + 24.0°
 Efficiency 88 %
 Peak intensity 1.8 cd/lm
 LEDs/each optic 1
 Light colour White
 Required components:
 F15255_HEKLA-SOCKET-C

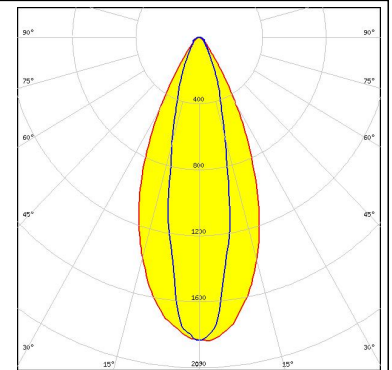

TRIDONIC

LED SLE G7 LES13
 FWHM 52.0 + 35.0°
 Efficiency 84 %
 Peak intensity 1.1 cd/lm
 LEDs/each optic 1
 Light colour White
 Required components:
 F15859_HEKLA-SOCKET-I

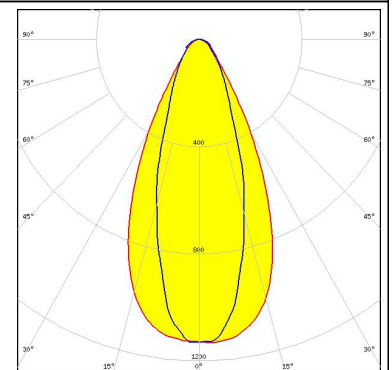
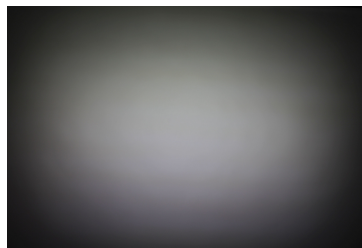

TRIDONIC

LED SLE G7 LES15
 FWHM 55.0 + 39.0°
 Efficiency 83 %
 Peak intensity 1 cd/lm
 LEDs/each optic 1
 Light colour White
 Required components:
 F15859_HEKLA-SOCKET-I

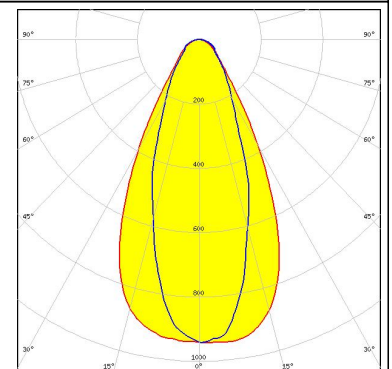
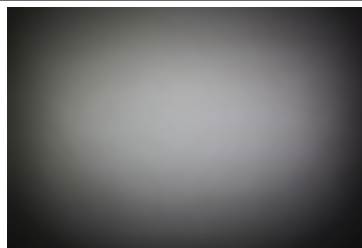

XICATO

LED XOB 14.5 mm
 FWHM 54.0 + 36.0°
 Efficiency 83 %
 Peak intensity 1 cd/lm
 LEDs/each optic 1
 Light colour White
 Required components:
 F15859_HEKLA-SOCKET-I

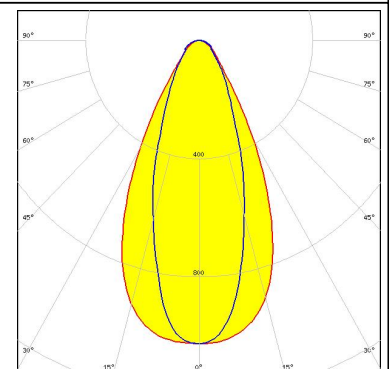
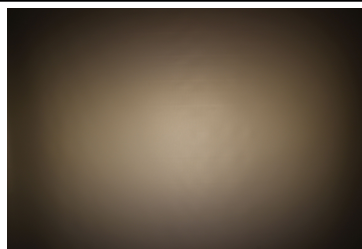

PHOTOMETRIC DATA (MEASURED):

XICATO

LED XOB 9.8 mm
FWHM 48.0 + 24.0°
Efficiency 89 %
Peak intensity 1.8 cd/lm
LEDs/each optic 1
Light colour White
Required components:
F15255_HEKLA-SOCKET-C

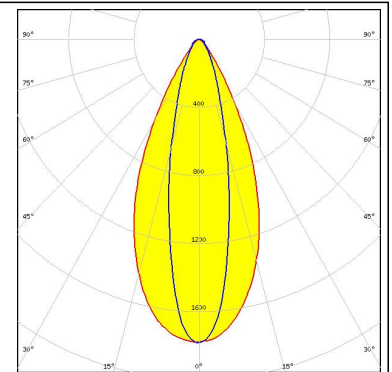

XICATO

LED XTM - 19mm LES
FWHM 57.0 + 40.0°
Efficiency 82 %
Peak intensity 0.8 cd/lm
LEDs/each optic 1
Light colour White
Required components:
C16058_XTM-ADAPTER-50-C

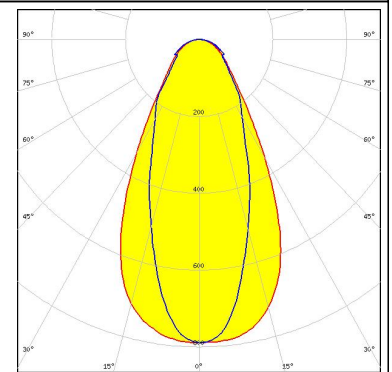

PHOTOMETRIC DATA (SIMULATED):



LED COB T-Type
FWHM 28.0 + 47.0°
Efficiency 86 %
Peak intensity 2.5 cd/lm
LEDs/each optic 1
Light colour White
Required components:
F15848_HEKLA-SOCKET-G

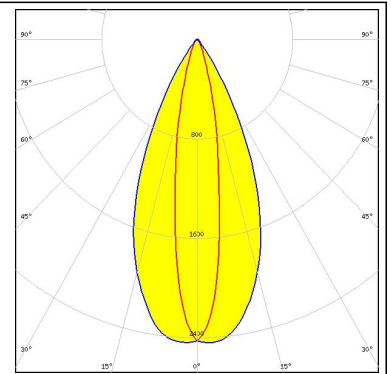

GENERAL INFORMATION:

NOTE: The typical beam angle will be changed by different color, chip size and chip position tolerance. The typical total beam angle is the full angle measured where the luminous intensity is half of the peak value.

Due to use of high power COB's with this product, special attention to proper thermal design is highly recommended. LEDiL has no liability for direct, indirect or consecutive damages arising from the LEDiL products being used outside of the recommended temperature range.

MATERIALS:

As part of our continuous research and improvement processes, and to ensure the best possible quality and availability of our products, LEDiL reserves the right to change material grades without notice.

PRODUCT DATA USER AGREEMENT AND DISCLAIMER:

The measured data in the provided downloadable LEDiL Product Datasheets and Mechanical 2D-Drawings is rounded and provided as reference for planning. LEDiL Oy's optical specifications have been verified by conducting performance testing of the products in accordance with the company's quality system. The reported data are averaged results of multiple measurements with typical variation. LEDiL Oy reserves the right to without prior notification make changes and improvements to its products.

LEDiL Oy assumes neither warranty, nor guarantee nor any other liability of any kind for the contents and correctness of the provided data. The provided data has been generated with highest diligence but the provided data may in reality not represent the complete possible variation range of all intrinsic parameters. Therefore, in certain cases a deviation from the provided data could occur.

LEDiL Oy reserves the right to undertake technical changes of its products without further notification which could lead to changes in the provided data. LEDiL Oy assumes no liability of any kind for the possible deviation from any provided data or any other damage resulting from the usage of the provided data.

The user agrees to this disclaimer and user agreement with the download or usage of the provided files.

LEDiL Oy

Joensuunkatu 13
FI-24240 SALO
Finland

LEDiL Inc.

228 West Page Street
Suite D
Sycamore IL 60178
USA

Local sales and technical support

www.ledil.com/where_to_buy

Shipping locations

Salo, Finland
Hong Kong, China

Distribution Partners

www.ledil.com/where_to_buy

Компания «Life Electronics» занимается поставками электронных компонентов импортного и отечественного производства от производителей и со складов крупных дистрибьюторов Европы, Америки и Азии.

С конца 2013 года компания активно расширяет линейку поставок компонентов по направлению коаксиальный кабель, кварцевые генераторы и конденсаторы (керамические, пленочные, электролитические), за счёт заключения дистрибьюторских договоров

Мы предлагаем:

- Конкурентоспособные цены и скидки постоянным клиентам.
- Специальные условия для постоянных клиентов.
- Подбор аналогов.
- Поставку компонентов в любых объемах, удовлетворяющих вашим потребностям.
- Приемлемые сроки поставки, возможна ускоренная поставка.
- Доставку товара в любую точку России и стран СНГ.
- Комплексную поставку.
- Работу по проектам и поставку образцов.
- Формирование склада под заказчика.
- Сертификаты соответствия на поставляемую продукцию (по желанию клиента).
- Тестирование поставляемой продукции.
- Поставку компонентов, требующих военную и космическую приемку.
- Входной контроль качества.
- Наличие сертификата ISO.

В составе нашей компании организован Конструкторский отдел, призванный помогать разработчикам, и инженерам.

Конструкторский отдел помогает осуществить:

- Регистрацию проекта у производителя компонентов.
- Техническую поддержку проекта.
- Защиту от снятия компонента с производства.
- Оценку стоимости проекта по компонентам.
- Изготовление тестовой платы монтаж и пусконаладочные работы.



Тел: +7 (812) 336 43 04 (многоканальный)
Email: org@lifeelectronics.ru