

## ISL83483, ISL83485, ISL83488, ISL83490, ISL83491

3.3V, Low Power, High Speed or Slew Rate Limited, RS-485/RS-422 Transceivers

FN6052  
Rev.5.01  
Mar 12, 2020

These Renesas RS-485/RS-422 devices are BiCMOS 3.3V powered, single transceivers that meet both the RS-485 and RS-422 standards for balanced communication. Unlike competitive devices, this Renesas family is specified for 10% tolerance supplies (3V to 3.6V).

The [ISL83483](#) and [ISL83488](#) use slew rate limited drivers which reduce EMI, and minimize reflections from improperly terminated transmission lines, or unterminated stubs in multidrop and multipoint applications.

Data rates up to 10Mbps are achievable by using the [ISL83485](#), [ISL83490](#), or [ISL83491](#), which feature higher slew rates.

Logic inputs (for example, DI and DE) accept signals in excess of 5.5V, making them compatible with 5V logic families.

Receiver (Rx) inputs feature a “fail-safe if open” design, which ensures a logic high output if Rx inputs are floating. All devices present a “single unit load” to the RS-485 bus, which allows up to 32 transceivers on the network.

Driver (Tx) outputs are short-circuit protected, even for voltages exceeding the power supply voltage. Additionally, on-chip thermal shutdown circuitry disables the Tx outputs to prevent damage if power dissipation becomes excessive.

The ISL83488, ISL83490, and ISL83491 are configured for full duplex (separate Rx input and Tx output pins) applications. The ISL83488 and ISL83490 are offered in space saving 8 Ld packages for applications not requiring Rx and Tx output disable functions (for example, point-to-point and RS-422). Half duplex configurations (ISL83483, ISL83485) multiplex the Rx inputs and Tx outputs to provide transceivers with Rx and Tx disable functions in 8 Ld packages.

### Features

- Operate from a single +3.3V supply (10% tolerance)
- Interoperable with 5V logic
- High data rates . . . . . up to 10Mbps
- Single unit load allows up to 32 devices on the bus
- Slew rate limited versions for error free data transmission (ISL83483, ISL83488) . . . . . up to 250kbps
- Low current Shutdown mode (ISL83483, ISL83485, ISL83491). . . . . 15nA
- -7V to +12V common-mode input voltage range
- Three-state Rx and Tx outputs (except ISL83488, ISL83490)
- 10ns propagation delay, 1ns skew (ISL83485, ISL83490, ISL83491)
- Full duplex and half duplex pinouts
- Current limiting and thermal shutdown for driver overload protection
- Pb-free (RoHS compliant)

### Applications

- Factory automation
- Security networks
- Building environmental control systems
- Industrial/process control networks
- Level translators (for example, RS-232 to RS-422)
- RS-232 “Extension Cords”

### Related Literature

For a full list of related documents, visit our website:

- [ISL83483](#), [ISL83485](#), [ISL83488](#), [ISL83490](#), [ISL83491](#) device pages

TABLE 1. SUMMARY OF FEATURES

PART NUMBER	HALF/FULL DUPLEX	DATA RATE (Mbps)	SLEW-RATE LIMITED?	RECEIVER/DRIVER ENABLE?	QUIESCENT I <sub>CC</sub> (mA)	LOW POWER SHUTDOWN?	PIN COUNT
ISL83483	Half	0.25	Yes	Yes	0.65	Yes	8
ISL83485	Half	10	No	Yes	0.65	Yes	8
ISL83488	Full	0.25	Yes	No	0.65	No	8
ISL83490	Full	10	No	No	0.65	No	8
ISL83491	Full	10	No	Yes	0.65	Yes	14

## Ordering Information

PART NUMBER (Notes 2, 3)	PART MARKING	TEMP. RANGE (°C)	TAPE AND REEL (UNITS) (Note 1)	PACKAGE (RoHS Compliant)	PKG. DWG. #
ISL83483IBZ	83483 IBZ	-40 to +85	-	8 Ld SOIC	M8.15
ISL83483IBZ-T	83483 IBZ	-40 to +85	2.5k	8 Ld SOIC	M8.15
ISL83483IBZ-T7A	83483 IBZ	-40 to +85	250	8 Ld SOIC	M8.15
ISL83485IBZ	83485 IBZ	-40 to +85	-	8 Ld SOIC	M8.15
ISL83485IBZ-T	83485 IBZ	-40 to +85	2.5k	8 Ld SOIC	M8.15
ISL83485IBZ-T7A	83485 IBZ	-40 to +85	250	8 Ld SOIC	M8.15
ISL83488IBZ	83488 IBZ	-40 to +85	-	8 Ld SOIC	M8.15
ISL83488IBZ-T	83488 IBZ	-40 to +85	2.5k	8 Ld SOIC	M8.15
ISL83490IBZ	83490 IBZ	-40 to +85	-	8 Ld SOIC	M8.15
ISL83490IBZ-T	83490 IBZ	-40 to +85	2.5k	8 Ld SOIC	M8.15
ISL83491IBZ	83491IBZ	-40 to +85	-	14 Ld SOIC	M14.15
ISL83491IBZ-T	83491IBZ	-40 to +85	2.5k	14 Ld SOIC	M14.15
ISL83491IBZ-T7A	83491IBZ	-40 to +85	250	14 Ld SOIC	M14.15

### NOTES:

- See [TB347](#) for details about reel specifications.
- These Pb-free plastic packaged products employ special Pb-free material sets, molding compounds/die attach materials, and 100% matte tin plate plus anneal (e3 termination finish, which is RoHS compliant and compatible with both SnPb and Pb-free soldering operations). Pb-free products are MSL classified at Pb-free peak reflow temperatures that meet or exceed the Pb-free requirements of IPC/JEDEC J STD-020.
- For Moisture Sensitivity Level (MSL), refer to the [ISL83483](#), [ISL83485](#), [ISL83488](#), [ISL83490](#), and [ISL83491](#) device pages. For more information about MSL, see [TB363](#).

**Pinouts**



**Truth Tables**

TRANSMITTING				
INPUTS			OUTPUTS	
RE	DE	DI	Z	Y
X	1	1	0	1
X	1	0	1	0
0	0	X	High-Z	High-Z
1	0	X	High-Z *	High-Z *

NOTE: \*Shutdown Mode for ISL83483, ISL83485, ISL83491

RECEIVING				
INPUTS				OUTPUT
RE	DE Half Duplex	DE Full Duplex	A-B	RO
0	0	X	$\geq +0.2V$	1
0	0	X	$\leq -0.2V$	0
0	0	X	Inputs Open	1
1	0	0	X	High-Z *
1	1	1	X	High-Z

NOTE: \*Shutdown Mode for ISL83483, ISL83485, ISL83491

**Pin Descriptions**

PIN	FUNCTION
RO	Receiver output: If $A > B$ by at least 0.2V, RO is high; If $A < B$ by 0.2V or more, RO is low; RO = High if A and B are unconnected (floating).
RE	Receiver output enable. RO is enabled when RE is low; RO is high impedance when RE is high.
DE	Driver output enable. The driver outputs, Y and Z, are enabled by bringing DE high. They are high impedance when DE is low.
DI	Driver input. A low on DI forces output Y low and output Z high. Similarly, a high on DI forces output Y high and output Z low.
GND	Ground connection.
AY	Noninverting receiver input and noninverting driver output. Pin is an input if DE = 0; pin is an output if DE = 1.
B/Z	Inverting receiver input and inverting driver output. Pin is an input if DE = 0; pin is an output if DE = 1.
A	Noninverting receiver input.
B	Inverting receiver input.
Y	Noninverting driver output.
Z	Inverting driver output.
VCC	System power supply input (3V to 3.6V).
NC	No Connection.

### Typical Operating Circuits

For calculating the resistor values refer to [TB509](#), "Detecting Bus Signals Correctly with Failsafe Biased RS-485 Receivers"



FIGURE 1. ISL83483, ISL83485



FIGURE 2. ISL83488, ISL83490



FIGURE 3. ISL83491

**Absolute Maximum Ratings**

$V_{CC}$ to Ground	7V
Input Voltages	
DI, DE, $\overline{RE}$	-0.5V to +7V
Input/Output Voltages	
A, B, Y, Z	-8V to +12.5V
RO	-0.5V to ( $V_{CC} + 0.5V$ )
Short-Circuit Duration	
Y, Z	Continuous
ESD Rating	
Human Body Model (Tested per JS-001-2017)	1kV
Machine Model (Tested per JESD22-A115C)	.50V
Charge Device Model (Tested per JS-002-2014)	1kV

**Thermal Information**

Thermal Resistance (Typical, <a href="#">Note 4</a> )	$\theta_{JA}$ (°C/W)
8 Ld SOIC Package	170
14 Ld SOIC Package	130
Maximum Junction Temperature (Plastic Package)	+150°C
Maximum Storage Temperature Range	-65°C to +150°C
Pb-Free Reflow Profile	see <a href="#">TB493</a>

**Operating Conditions**

Temperature Range . . . . . -40°C to +85°C

**CAUTION:** Stresses above those listed in "Absolute Maximum Ratings" can cause permanent damage to the device. This is a stress only rating and operation of the device at these or any other conditions above those indicated in the operational sections of this specification is not implied.

NOTE:

4.  $\theta_{JA}$  is measured with the component mounted on a low-effective thermal conductivity test board in free air. See [TB379](#).

**Electrical Specifications** Test conditions:  $V_{CC} = 3V$  to 3.6V; unless otherwise specified. Typical values are at  $V_{CC} = 3.3V$ ,  $T_A = +25^\circ C$ , [Note 5](#).

PARAMETER	SYMBOL	TEST CONDITIONS	TEMP (°C)	MIN	TYP	MAX	UNIT	
<b>DC CHARACTERISTICS</b>								
Driver Differential $V_{OUT}$ (no load)	$V_{OD1}$		Full	-	-	$V_{CC}$	V	
Driver Differential $V_{OUT}$ (with load)	$V_{OD2}$	$R_L = 100\Omega$ (RS-422) ( <a href="#">Figure 4A</a> )	Full	2	2.7	-	V	
		$R_L = 54\Omega$ (RS-485) ( <a href="#">Figure 4A</a> )	Full	1.5	2.3	$V_{CC}$	V	
		$R_L = 60\Omega$ , $-7V \leq V_{CM} \leq 12V$ ( <a href="#">Figure 4B</a> )	Full	1.5	2.6	-	V	
Change in Magnitude of Driver Differential $V_{OUT}$ for Complementary Output States	$\Delta V_{OD}$	$R_L = 54\Omega$ or $100\Omega$ ( <a href="#">Figure 4A</a> )	Full	-	0.01	0.2	V	
Driver Common-Mode $V_{OUT}$	$V_{OC}$	$R_L = 54\Omega$ or $100\Omega$ ( <a href="#">Figure 4A</a> )	Full	-	1.8	3	V	
Change in Magnitude of Driver Common-Mode $V_{OUT}$ for Complementary Output States	$\Delta V_{OC}$	$R_L = 54\Omega$ or $100\Omega$ ( <a href="#">Figure 4A</a> )	Full	-	0.01	0.2	V	
Logic Input High Voltage	$V_{IH}$	DE, DI, $\overline{RE}$	Full	2	-	-	V	
Logic Input Low Voltage	$V_{IL}$	DE, DI, $\overline{RE}$	Full	-	-	0.8	V	
Logic Input Current	$I_{IN1}$	DE, DI	Full	-2	-	2	$\mu A$	
		$\overline{RE}$	Full	-25	-	25	$\mu A$	
Input Current (A, B)	$I_{IN2}$	DE = 0V, $V_{CC} = 0V$ or 3.6V	$V_{IN} = 12V$	Full	-	0.6	1	mA
			$V_{IN} = -7V$	Full	-	-0.3	-0.8	mA
Output Leakage Current (Y, Z) (ISL83491)	$I_{IN3}$	$\overline{RE} = 0V$ , DE = 0V, $V_{CC} = 0V$ or 3.6V	$V_{IN} = 12V$	Full	-	14	20	$\mu A$
			$V_{IN} = -7V$	Full	-20	-11	-	$\mu A$
Output Leakage Current (Y, Z) in Shutdown Mode (ISL83491)	$I_{IN3}$	$\overline{RE} = V_{CC}$ , DE = 0V, $V_{CC} = 0V$ or 3.6V	$V_{IN} = 12V$	Full	-	0.03	1	$\mu A$
			$V_{IN} = -7V$	Full	-1	-0.01	-	$\mu A$
Receiver Differential Threshold Voltage	$V_{TH}$	$-7V \leq V_{CM} \leq 12V$	Full	-0.2	-	0.2	V	
Receiver Input Hysteresis	$\Delta V_{TH}$	$V_{CM} = 0V$	+25	-	50	-	mV	
Receiver Output High Voltage	$V_{OH}$	$I_O = -4mA$ , $V_{ID} = 200mV$	Full	$V_{CC} - 0.4$	-	-	V	

**Electrical Specifications** Test conditions:  $V_{CC} = 3V$  to  $3.6V$ ; unless otherwise specified. Typical values are at  $V_{CC} = 3.3V$ ,  $T_A = +25^\circ C$ , [Note 5](#). (Continued)

PARAMETER	SYMBOL	TEST CONDITIONS	TEMP (°C)	MIN	TYP	MAX	UNIT	
Receiver Output Low Voltage	$V_{OL}$	$I_O = -4mA$ , $V_{ID} = 200mV$	Full	-	-	0.4	V	
Three-State (high impedance) Receiver Output Current	$I_{OZR}$	$0.4V \leq V_O \leq 2.4V$	Full	-1	-	1	$\mu A$	
Receiver Input Resistance	$R_{IN}$	$-7V \leq V_{CM} \leq 12V$	Full	12	19	-	k $\Omega$	
No-Load Supply Current ( <a href="#">Note 6</a> )	$I_{CC}$	$DI = 0V$ or $V_{CC}$	$DE = V_{CC}$ , $RE = 0V$ or $V_{CC}$	Full	-	0.75	1.2	mA
			$DE = 0V$ , $RE = 0V$	Full	-	0.65	1	mA
Shutdown Supply Current (Except ISL83488 and ISL83490)	$I_{SHDN}$	$DE = 0V$ , $\overline{RE} = V_{CC}$ , $DI = 0V$ or $V_{CC}$	Full	-	15	100	nA	
Driver Short-Circuit Current, $V_O =$ High or Low	$I_{OSD1}$	$DE = V_{CC}$ , $-7V \leq V_Y$ or $V_Z \leq 12V$ ( <a href="#">Note 7</a> )	Full	-	-	250	mA	
Receiver Short-Circuit Current	$I_{OSR}$	$0V \leq V_O \leq V_{CC}$	Full	8	-	60	mA	
<b>DRIVER SWITCHING CHARACTERISTICS (ISL83485, ISL83490, ISL83491)</b>								
Maximum Data Rate	$f_{MAX}$		Full	12	15	-	Mbps	
Driver Differential Output Delay	$t_{DD}$	$R_{DIFF} = 60\Omega$ , $C_L = 15pF$ ( <a href="#">Figure 5A</a> )	Full	1	10	35	ns	
Driver Differential Rise or Fall Time	$t_R$ , $t_F$	$R_{DIFF} = 60\Omega$ , $C_L = 15pF$ ( <a href="#">Figure 5A</a> )	Full	3	5	20	ns	
Driver Input to Output Delay	$t_{PLH}$ , $t_{PHL}$	$R_L = 27\Omega$ , $C_L = 15pF$ ( <a href="#">Figure 5C</a> )	Full	6	10	35	ns	
Driver Output Skew	$t_{SKEW}$	$R_L = 27\Omega$ , $C_L = 15pF$ ( <a href="#">Figure 5C</a> )	Full	-	1	8	ns	
Driver Enable to Output High (Except ISL83490)	$t_{ZH}$	$R_L = 110\Omega$ , $C_L = 50pF$ , $SW = GND$ ( <a href="#">Figure 6</a> ), ( <a href="#">Note 8</a> )	Full	-	45	90	ns	
Driver Enable to Output Low (Except ISL83490)	$t_{ZL}$	$R_L = 110\Omega$ , $C_L = 50pF$ , $SW = V_{CC}$ ( <a href="#">Figure 6</a> ), ( <a href="#">Note 8</a> )	Full	-	45	90	ns	
Driver Disable from Output High (Except ISL83490)	$t_{HZ}$	$R_L = 110\Omega$ , $C_L = 50pF$ , $SW = GND$ ( <a href="#">Figure 6</a> )	+25	-	65	80	ns	
			Full	-	-	110	ns	
Driver Disable from Output Low (Except ISL83490)	$t_{LZ}$	$R_L = 110\Omega$ , $C_L = 50pF$ , $SW = V_{CC}$ ( <a href="#">Figure 6</a> )	+25	-	65	80	ns	
			Full	-	-	110	ns	
Driver Enable from Shutdown to Output High (Except ISL83490)	$t_{ZH}(SHDN)$	$R_L = 110\Omega$ , $C_L = 50pF$ , $SW = GND$ ( <a href="#">Figure 6</a> ), ( <a href="#">Notes 10, 11</a> )	Full	-	115	150	ns	
Driver Enable from Shutdown to Output Low (Except ISL83490)	$t_{ZL}(SHDN)$	$R_L = 110\Omega$ , $C_L = 50pF$ , $SW = V_{CC}$ ( <a href="#">Figure 6</a> ), ( <a href="#">Notes 10, 11</a> )	Full	-	115	150	ns	
<b>DRIVER SWITCHING CHARACTERISTICS (ISL83483, ISL83488)</b>								
Maximum Data Rate	$f_{MAX}$		Full	250	-	-	kbps	
Driver Differential Output Delay	$t_{DD}$	$R_{DIFF} = 60\Omega$ , $C_L = 15pF$ ( <a href="#">Figure 5A</a> )	Full	600	930	1400	ns	
Driver Differential Rise or Fall Time	$t_R$ , $t_F$	$R_{DIFF} = 60\Omega$ , $C_L = 15pF$ ( <a href="#">Figure 5A</a> )	Full	400	900	1200	ns	
Driver Input to Output Delay	$t_{PLH}$ , $t_{PHL}$	$R_L = 27\Omega$ , $C_L = 15pF$ ( <a href="#">Figure 5C</a> )	+25	600	930	1500	ns	
			Full	400	-	1500	ns	
Driver Output Skew	$t_{SKEW}$	$R_L = 27\Omega$ , $C_L = 15pF$ ( <a href="#">Figure 5C</a> )	Full	-	140	-	ns	
Driver Enable to Output High (Except ISL83488)	$t_{ZH}$	$R_L = 110\Omega$ , $C_L = 50pF$ , $SW = GND$ ( <a href="#">Figure 6</a> ), ( <a href="#">Note 8</a> )	Full	-	385	800	ns	
Driver Enable to Output Low (Except ISL83488)	$t_{ZL}$	$R_L = 110\Omega$ , $C_L = 50pF$ , $SW = V_{CC}$ ( <a href="#">Figure 6</a> ), ( <a href="#">Note 8</a> )	Full	-	55	800	ns	
Driver Disable from Output High (Except ISL83488)	$t_{HZ}$	$R_L = 110\Omega$ , $C_L = 50pF$ , $SW = GND$ ( <a href="#">Figure 6</a> )	+25	-	63	80	ns	
			Full	-	-	110	ns	

**Electrical Specifications** Test conditions:  $V_{CC} = 3V$  to  $3.6V$ ; unless otherwise specified. Typical values are at  $V_{CC} = 3.3V$ ,  $T_A = +25^\circ C$ , [Note 5](#). (Continued)

PARAMETER	SYMBOL	TEST CONDITIONS	TEMP (°C)	MIN	TYP	MAX	UNIT
Driver Disable from Output Low (Except ISL83488)	$t_{LZ}$	$R_L = 110\Omega$ , $C_L = 50pF$ , $SW = V_{CC}$ ( <a href="#">Figure 6</a> )	+25	-	70	80	ns
			Full	-	-	110	ns
Driver Enable from Shutdown to Output High (Except ISL83488)	$t_{ZH}(SHDN)$	$R_L = 110\Omega$ , $C_L = 50pF$ , $SW = GND$ ( <a href="#">Notes 10, 11</a> )	Full	-	450	2000	ns
Driver Enable from Shutdown to Output Low (Except ISL83488)	$t_{ZL}(SHDN)$	$R_L = 110\Omega$ , $C_L = 50pF$ , $SW = V_{CC}$ ( <a href="#">Figure 6</a> ), ( <a href="#">Notes 10, 11</a> )	Full	-	126	2000	ns
<b>RECEIVER SWITCHING CHARACTERISTICS (All Versions)</b>							
Receiver Input to Output Delay	$t_{PLH}$ , $t_{PHL}$	( <a href="#">Figure 7</a> )	Full	25	45	90	ns
Receiver Skew   $t_{PLH} - t_{PHL}$	$t_{SKD}$	(Figure 7)	+25	-	2	10	ns
			Full	-	2	12	ns
Receiver Enable to Output High (Except ISL83488 and ISL83490)	$t_{ZH}$	$R_L = 1k\Omega$ , $C_L = 15pF$ , $SW = GND$ ( <a href="#">Figure 8</a> ), ( <a href="#">Note 9</a> )	Full	-	11	50	ns
Receiver Enable to Output Low (Except ISL83488 and ISL83490)	$t_{ZL}$	$R_L = 1k\Omega$ , $C_L = 15pF$ , $SW = V_{CC}$ ( <a href="#">Figure 8</a> ), ( <a href="#">Note 9</a> )	Full	-	11	50	ns
Receiver Disable from Output High (Except ISL83488 and ISL83490)	$t_{HZ}$	$R_L = 1k\Omega$ , $C_L = 15pF$ , $SW = GND$ ( <a href="#">Figure 8</a> )	Full	-	7	45	ns
Receiver Disable from Output Low (Except ISL83488 and ISL83490)	$t_{LZ}$	$R_L = 1k\Omega$ , $C_L = 15pF$ , $SW = V_{CC}$ ( <a href="#">Figure 8</a> )	Full	-	7	45	ns
Time to Shutdown (Except ISL83488 and ISL83490)	$t_{SHDN}$	( <a href="#">Note 10</a> )	Full	80	190	300	ns
Receiver Enable from Shutdown to Output High (Except ISL83488 and ISL83490)	$t_{ZH}(SHDN)$	$R_L = 1k\Omega$ , $C_L = 15pF$ , $SW = GND$ ( <a href="#">Figure 8</a> ), ( <a href="#">Notes 10, 11</a> )	Full	-	240	600	ns
Receiver Enable from Shutdown to Output Low (Except ISL83488 and ISL83490)	$t_{ZL}(SHDN)$	$R_L = 1k\Omega$ , $C_L = 15pF$ , $SW = V_{CC}$ ( <a href="#">Figure 8</a> ), ( <a href="#">Notes 10, 11</a> )	Full	-	240	600	ns

## NOTES:

- All currents into device pins are positive; all currents out of device pins are negative. All voltages are referenced to device ground unless otherwise specified.
- Supply current specification is valid for loaded drivers when  $DE = 0V$ .
- Applies to peak current. See "[Typical Performance Curves](#)" on [page 11](#) for more information.
- When testing the ISL83483, ISL83485, and ISL83491, keep  $\overline{RE} = 0$  to prevent the device from entering SHDN.
- When testing the ISL83483, ISL83485, and ISL83491, the  $\overline{RE}$  signal high time must be short enough (typically  $<100ns$ ) to prevent the device from entering SHDN.
- The ISL83483, ISL83485, and ISL83491 are put into shutdown by bringing  $\overline{RE}$  high and  $DE$  low. If the inputs are in this state for less than 80ns, the parts are ensured not to enter shutdown. If the inputs are in this state for at least 300ns, the parts are ensured to have entered shutdown. See "[Low Power Shutdown Mode \(ISL83483, ISL83485, ISL83491 Only\)](#)" on [page 11](#).
- Keep  $\overline{RE} = V_{CC}$ , and set the  $DE$  signal low time  $>300ns$  to ensure that the device enters SHDN.
- Set the  $\overline{RE}$  signal high time  $>300ns$  to ensure that the device enters SHDN.

**Test Circuits and Waveforms**



FIGURE 4A.  $V_{OD}$  AND  $V_{OC}$



FIGURE 4B.  $V_{OD}$  WITH COMMON MODE LOAD

FIGURE 4. DC DRIVER TEST CIRCUITS



FIGURE 5A. DIFFERENTIAL TEST CIRCUIT



FIGURE 5C. SINGLE ENDED TEST CIRCUIT

FIGURE 5. DRIVER PROPAGATION DELAY AND DIFFERENTIAL TRANSITION TIMES



FIGURE 5B. MEASUREMENT POINTS



**Test Circuits and Waveforms** (Continued)



PARAMETER	OUTPUT	$\overline{RE}$	DI	SW
$t_{HZ}$	Y/Z	X	1/0	GND
$t_{LZ}$	Y/Z	X	0/1	$V_{CC}$
$t_{ZH}$	Y/Z	0 (Note 8)	1/0	GND
$t_{ZL}$	Y/Z	0 (Note 8)	0/1	$V_{CC}$
$t_{ZH(SHDN)}$	Y/Z	1 (Note 11)	1/0	GND
$t_{ZL(SHDN)}$	Y/Z	1 (Note 11)	0/1	$V_{CC}$

FIGURE 6A. TEST CIRCUIT

FIGURE 6. DRIVER ENABLE AND DISABLE TIMES (EXCLUDING ISL83488, ISL83490)



FIGURE 6B. MEASUREMENT POINTS



FIGURE 7A. TEST CIRCUIT

FIGURE 7. RECEIVER PROPAGATION DELAY

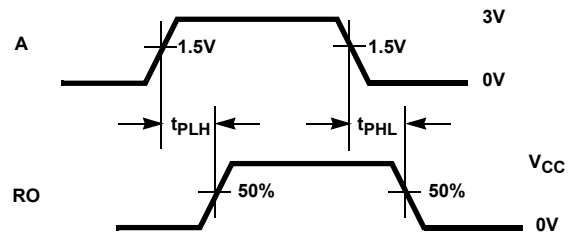

FIGURE 7B. MEASUREMENT POINTS



PARAMETER	DE	A	SW
$t_{HZ}$	0	+1.5V	GND
$t_{LZ}$	0	-1.5V	$V_{CC}$
$t_{ZH}$ (Note 9)	0	+1.5V	GND
$t_{ZL}$ (Note 9)	0	-1.5V	$V_{CC}$
$t_{ZH(SHDN)}$ (Note 12)	0	+1.5V	GND
$t_{ZL(SHDN)}$ (Note 12)	0	-1.5V	$V_{CC}$

FIGURE 8A. TEST CIRCUIT

FIGURE 8. RECEIVER ENABLE AND DISABLE TIMES (EXCLUDING ISL83488, ISL83490)

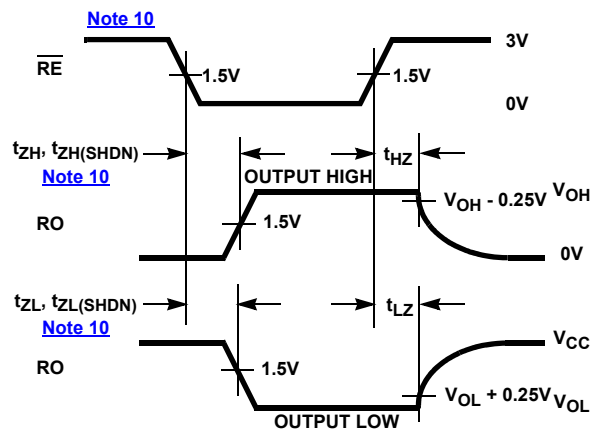

FIGURE 8B. MEASUREMENT POINTS

## Application Information

RS-485 and RS-422 are differential (balanced) data transmission standards for use in long haul or noisy environments. RS-422 is a subset of RS-485, so RS-485 transceivers are also RS-422 compliant. RS-422 is a point-to-multipoint (multidrop) standard, which allows only one driver and up to 10 (assuming one unit load devices) receivers on each bus. RS-485 is a true multipoint standard, which allows up to 32 one unit load devices (any combination of drivers and receivers) on each bus. To allow for multipoint operation, the RS-485 specification requires that drivers must handle bus contention without sustaining any damage.

Another important advantage of RS-485 is the extended Common-Mode Range (CMR), which specifies that the driver outputs and receiver inputs withstand signals that range from +12V to -7V. RS-422 and RS-485 are intended for runs as long as 4000', so the wide CMR is necessary to handle ground potential differences, as well as voltages induced in the cable by external fields.

### Receiver Features

These devices use a differential input receiver for maximum noise immunity and common-mode rejection. Input sensitivity is  $\pm 200\text{mV}$ , as required by the RS422 and RS-485 specifications.

Receiver input impedance surpasses the RS-422 spec of  $4\text{k}\Omega$ , and meets the RS-485 "Unit Load" requirement of  $12\text{k}\Omega$  minimum.

Receiver inputs function with common-mode voltages as great as +9V/-7V outside the power supplies (that is, +12V and -7V), making them ideal for long networks where induced voltages are a realistic concern.

All the receivers include a "fail-safe if open" function that ensures a high level receiver output if the receiver inputs are unconnected (floating).

Receivers easily meet the data rates supported by the corresponding driver.

ISL83483, ISL83485, ISL83491 receiver outputs are tri-statable using the active low  $\overline{\text{RE}}$  input.

### Driver Features

The RS-485, RS-422 driver is a differential output device that delivers at least 1.5V across a  $54\Omega$  load (RS-485), and at least 2V across a  $100\Omega$  load (RS-422) even with  $V_{\text{CC}} = 3\text{V}$ . The drivers feature low propagation delay skew to maximize bit width, and to minimize EMI.

Drivers of the ISL83483, ISL83485, and ISL83491 are tri-statable using the active high DE input.

ISL83483 and ISL83488 driver outputs are slew rate limited to minimize EMI, and to minimize reflections in unterminated or improperly terminated networks. Data rate on these slew rate limited versions is a maximum of 250kbps. Outputs of ISL83485, ISL83490, and ISL83491 drivers are not limited, so

faster output transition times allow data rates of at least 10Mbps.

### Data Rate, Cables, and Terminations

RS-485 and RS-422 are intended for network lengths up to 4000', but the maximum system data rate decreases as the transmission length increases. Devices operating at 10Mbps are limited to lengths of a few hundred feet, while the 250kbps versions can operate at full data rates with lengths in excess of 1000'.

Twisted pair is the cable of choice for RS-485 and RS-422 networks. Twisted pair cables tend to pick up noise and other electromagnetically induced voltages as common-mode signals, which are effectively rejected by the differential receivers in these ICs.

Proper termination is imperative, when using the 10Mbps devices, to minimize reflections. Short networks using the 250kbps versions need not be terminated, but, terminations are recommended unless power dissipation is an overriding concern.

In point-to-point, or point-to-multipoint (single driver on bus) networks, the main cable should be terminated in its characteristic impedance (typically  $120\Omega$ ) at the end farthest from the driver. In multi-receiver applications, stubs connecting receivers to the main cable should be kept as short as possible. Multipoint (multi-driver) systems require that the main cable be terminated in its characteristic impedance at both ends. Stubs connecting a transceiver to the main cable should be kept as short as possible.

### Built-In Driver Overload Protection

As stated previously, the RS-485 specification requires that drivers survive worst case bus contentions undamaged. The ISL834xx devices meet this requirement through driver output short-circuit current limits, and on-chip thermal shutdown circuitry.

The driver output stages incorporate short-circuit current limiting circuitry, which ensures that the output current never exceeds the RS-485 specification, even at the common-mode voltage range extremes. Additionally, these devices use a foldback circuit which reduces the short-circuit current, and thus the power dissipation, whenever the contending voltage exceeds either supply.

In the event of a major short-circuit condition, the ISL834xx devices also include a thermal shutdown feature that disables the drivers whenever the die temperature becomes excessive. This eliminates the power dissipation, allowing the die to cool. The drivers automatically re-enable after the die temperature drops about  $15^\circ$ . If the contention persists, the thermal shutdown/re-enable cycle repeats until the fault is cleared. Receivers stay operational during thermal shutdown.

**Low Power Shutdown Mode (ISL83483, ISL83485, ISL83491 Only)**

These CMOS transceivers all use a fraction of the power required by their bipolar counterparts, but the ISL83483, ISL83485, and ISL83491 include a shutdown feature that reduces the already low quiescent  $I_{CC}$  to a 15nA trickle. They enter shutdown whenever the receiver and driver are **simultaneously** disabled ( $\overline{RE} = V_{CC}$  and  $DE = GND$ ) for a

period of at least 300ns. Disabling both the driver and the receiver for less than 80ns ensures that shutdown is not entered.

Note that receiver and driver enable times increase when these devices enable from shutdown. For more information refer to [Notes 8](#) through [12](#) on [page 7](#) at the end of the Electrical Specification table.

**Typical Performance Curves**  $V_{CC} = 3.3V, T_A = +25^\circ C, ISL83483 \text{ thru } ISL83491; \text{ Unless otherwise specified}$



FIGURE 9. DRIVER OUTPUT CURRENT vs DIFFERENTIAL OUTPUT VOLTAGE



FIGURE 10. DRIVER DIFFERENTIAL OUTPUT VOLTAGE vs TEMPERATURE



FIGURE 11. DRIVER OUTPUT CURRENT vs SHORT-CIRCUIT VOLTAGE

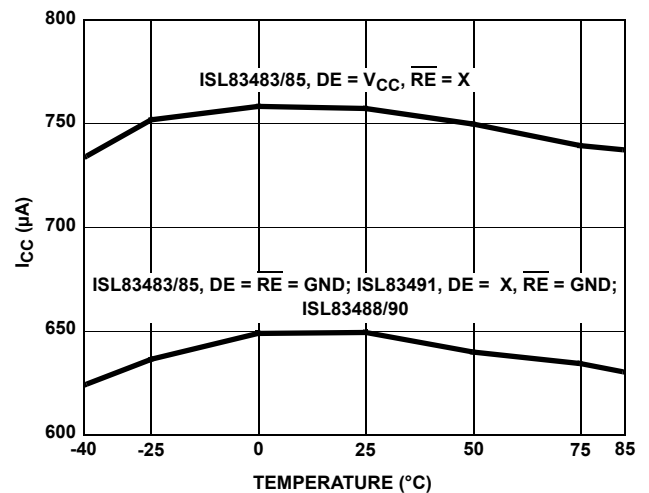

FIGURE 12. SUPPLY CURRENT vs TEMPERATURE

**Typical Performance Curves**  $V_{CC} = 3.3V$ ,  $T_A = +25^\circ C$ , ISL83483 thru ISL83491; Unless otherwise specified (Continued)



FIGURE 13. DRIVER PROPAGATION DELAY vs TEMPERATURE (ISL83483, ISL83488)



FIGURE 14. DRIVER SKEW vs TEMPERATURE (ISL83483, ISL83488)



FIGURE 15. DRIVER PROPAGATION DELAY vs TEMPERATURE (ISL83485, ISL83490, ISL83491)



FIGURE 16. DRIVER SKEW vs TEMPERATURE (ISL83485, ISL83490, ISL83491)



FIGURE 17. DRIVER AND RECEIVER WAVEFORMS, LOW TO HIGH (ISL83483, ISL83488)



FIGURE 18. DRIVER AND RECEIVER WAVEFORMS, HIGH TO LOW (ISL83483, ISL83488)

**Typical Performance Curves**  $V_{CC} = 3.3V$ ,  $T_A = +25^\circ C$ , ISL83483 thru ISL83491; Unless otherwise specified (Continued)



FIGURE 19. DRIVER AND RECEIVER WAVEFORMS, LOW TO HIGH (ISL83485, ISL83490, ISL83491)



FIGURE 20. DRIVER AND RECEIVER WAVEFORMS, HIGH TO LOW (ISL83485, ISL83490, ISL83491)

**Die Characteristics**

**SUBSTRATE POTENTIAL (POWERED UP):**

GND

**TRANSISTOR COUNT:**

528

**PROCESS:**

Si Gate CMOS

**Revision History** The revision history provided is for informational purposes only and is believed to be accurate, but not warranted. Please visit our website to make sure you have the latest revision.

DATE	REVISION	CHANGE
Mar 12, 2020	FN6052.5.01	Added ESD Rating to the Absolute Maximum Ratings. Removed PDIP parts and applicable information. Updated disclaimer.
Nov 21, 2018	FN6052.5	Updated part marking in the ordering information table to represent what the brand has been on the products. Added PDIP note in the thermal information section and specified the Pb-free reflow note is applicable to SOIC pages only. Updated disclaimer.
Jul 27, 2018	FN6052.4	Added Related Literature on page 1. Updated Ordering Information table. Removed Retired parts, added tape and reel quantity column, and added MSL note. Updated Typical Operating Circuits on page 4. Thermal Information on page 5: Removed Maximum Lead Temperature (Soldering 10s)+300 °C (SOIC - Lead Tips Only) Added Pb-Free Reflow information Updated POD M8.15 from rev 0 to rev 4. Changes since rev 0: Removed "u" symbol from drawing (overlaps the "a" on Side View). Updated to new POD format by removing table and moving dimensions onto drawing and adding land pattern Changed in Typical Recommended Land Pattern the following: 2.41(0.095) to 2.20(0.087) 0.76 (0.030) to 0.60(0.023) 0.200 to 5.20(0.205) Changed Note 1 "1982" to "1994" Updated POD M14.15 from rev 0 to rev 1. Changes since rev 0: Added land pattern and moved dimensions from table onto drawing Added Revision History. Updated disclaimer.

**Package Outline Drawings**

For the most recent package outline drawing, see [M8.15](#).

**M8.15**

8 LEAD NARROW BODY SMALL OUTLINE PLASTIC PACKAGE

Rev 4, 1/12

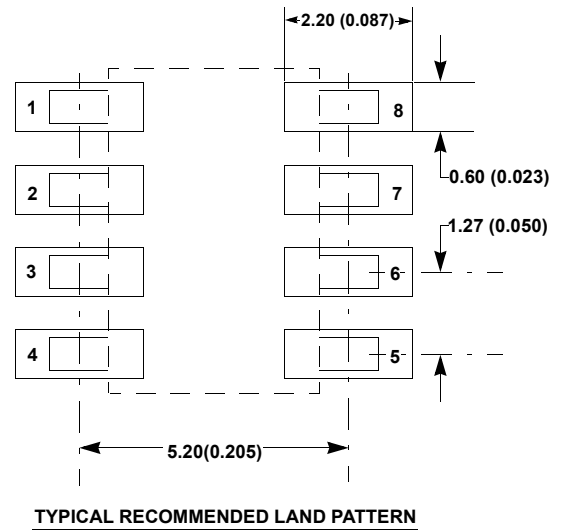
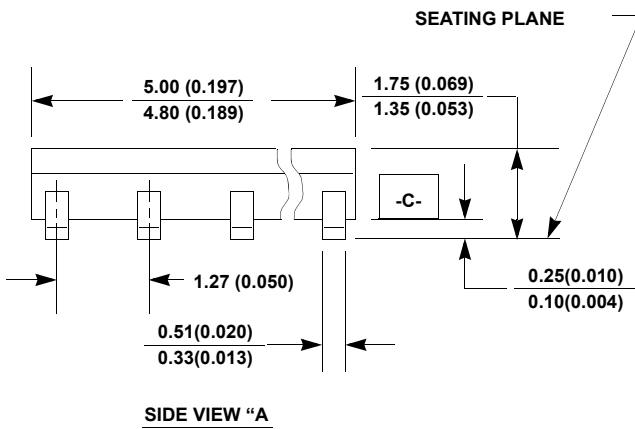
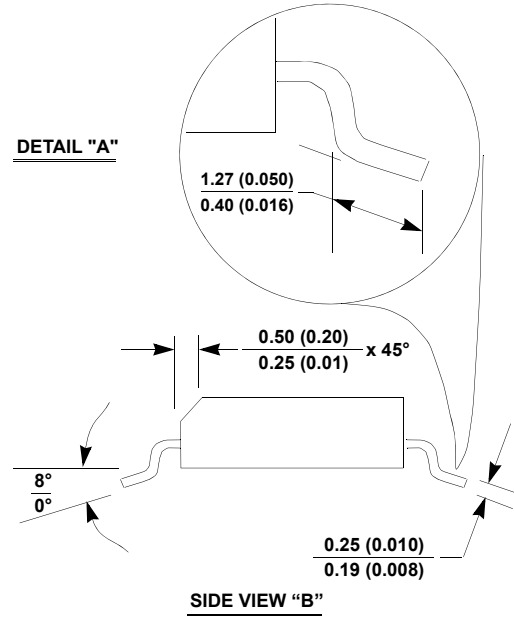
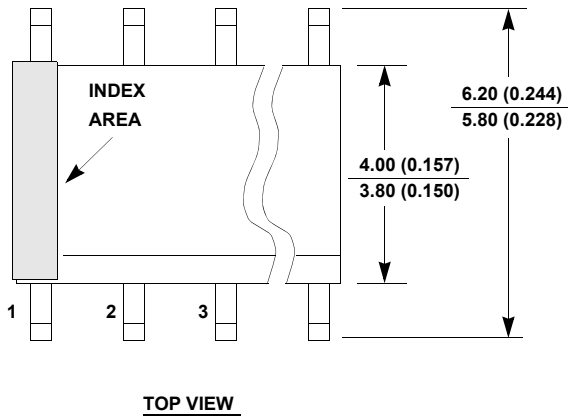

**NOTES:**

13. Dimensioning and tolerancing per ANSI Y14.5M-1994.
14. Package length does not include mold flash, protrusions or gate burrs. Mold flash, protrusion and gate burrs shall not exceed 0.15mm (0.006 inch) per side.
15. Package width does not include interlead flash or protrusions. Interlead flash and protrusions shall not exceed 0.25mm (0.010 inch) per side.
16. The chamfer on the body is optional. If it is not present, a visual index feature must be located within the crosshatched area.
17. Terminal numbers are shown for reference only.
18. The lead width as measured 0.36mm (0.014 inch) or greater above the seating plane, shall not exceed a maximum value of 0.61mm (0.024 inch).
19. Controlling dimension: MILLIMETER. Converted inch dimensions are not necessarily exact.
20. This outline conforms to JEDEC publication MS-012-AA ISSUE C.

**M14.15**

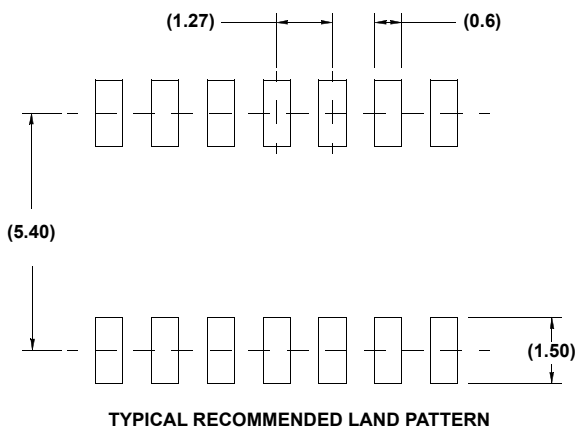

**NOTES:**

1. Dimensions are in millimeters.  
Dimensions in ( ) for Reference Only.
2. Dimensioning and tolerancing conform to AMSEY14.5m-1994.
3. Datums A and B to be determined at Datum H.
4. Dimension does not include interlead flash or protrusions.  
Interlead flash or protrusions shall not exceed 0.25mm per side.
5. The pin #1 identifier may be either a mold or mark feature.
6. Does not include dambar protrusion. Allowable dambar protrusion shall be 0.10mm total in excess of lead width at maximum condition.
7. Reference to JEDEC MS-012-AB.



## Notice

1. Descriptions of circuits, software and other related information in this document are provided only to illustrate the operation of semiconductor products and application examples. You are fully responsible for the incorporation or any other use of the circuits, software, and information in the design of your product or system. Renesas Electronics disclaims any and all liability for any losses and damages incurred by you or third parties arising from the use of these circuits, software, or information.
  2. Renesas Electronics hereby expressly disclaims any warranties against and liability for infringement or any other claims involving patents, copyrights, or other intellectual property rights of third parties, by or arising from the use of Renesas Electronics products or technical information described in this document, including but not limited to, the product data, drawings, charts, programs, algorithms, and application examples.
  3. No license, express, implied or otherwise, is granted hereby under any patents, copyrights or other intellectual property rights of Renesas Electronics or others.
  4. You shall not alter, modify, copy, or reverse engineer any Renesas Electronics product, whether in whole or in part. Renesas Electronics disclaims any and all liability for any losses or damages incurred by you or third parties arising from such alteration, modification, copying or reverse engineering.
  5. Renesas Electronics products are classified according to the following two quality grades: "Standard" and "High Quality". The intended applications for each Renesas Electronics product depends on the product's quality grade, as indicated below.
    - "Standard": Computers; office equipment; communications equipment; test and measurement equipment; audio and visual equipment; home electronic appliances; machine tools; personal electronic equipment; industrial robots; etc.
    - "High Quality": Transportation equipment (automobiles, trains, ships, etc.); traffic control (traffic lights); large-scale communication equipment; key financial terminal systems; safety control equipment; etc.Unless expressly designated as a high reliability product or a product for harsh environments in a Renesas Electronics data sheet or other Renesas Electronics document, Renesas Electronics products are not intended or authorized for use in products or systems that may pose a direct threat to human life or bodily injury (artificial life support devices or systems; surgical implantations; etc.), or may cause serious property damage (space system; undersea repeaters; nuclear power control systems; aircraft control systems; key plant systems; military equipment; etc.). Renesas Electronics disclaims any and all liability for any damages or losses incurred by you or any third parties arising from the use of any Renesas Electronics product that is inconsistent with any Renesas Electronics data sheet, user's manual or other Renesas Electronics document.
  6. When using Renesas Electronics products, refer to the latest product information (data sheets, user's manuals, application notes, "General Notes for Handling and Using Semiconductor Devices" in the reliability handbook, etc.), and ensure that usage conditions are within the ranges specified by Renesas Electronics with respect to maximum ratings, operating power supply voltage range, heat dissipation characteristics, installation, etc. Renesas Electronics disclaims any and all liability for any malfunctions, failure or accident arising out of the use of Renesas Electronics products outside of such specified ranges.
  7. Although Renesas Electronics endeavors to improve the quality and reliability of Renesas Electronics products, semiconductor products have specific characteristics, such as the occurrence of failure at a certain rate and malfunctions under certain use conditions. Unless designated as a high reliability product or a product for harsh environments in a Renesas Electronics data sheet or other Renesas Electronics document, Renesas Electronics products are not subject to radiation resistance design. You are responsible for implementing safety measures to guard against the possibility of bodily injury, injury or damage caused by fire, and/or danger to the public in the event of a failure or malfunction of Renesas Electronics products, such as safety design for hardware and software, including but not limited to redundancy, fire control and malfunction prevention, appropriate treatment for aging degradation or any other appropriate measures. Because the evaluation of microcomputer software alone is very difficult and impractical, you are responsible for evaluating the safety of the final products or systems manufactured by you.
  8. Please contact a Renesas Electronics sales office for details as to environmental matters such as the environmental compatibility of each Renesas Electronics product. You are responsible for carefully and sufficiently investigating applicable laws and regulations that regulate the inclusion or use of controlled substances, including without limitation, the EU RoHS Directive, and using Renesas Electronics products in compliance with all these applicable laws and regulations. Renesas Electronics disclaims any and all liability for damages or losses occurring as a result of your noncompliance with applicable laws and regulations.
  9. Renesas Electronics products and technologies shall not be used for or incorporated into any products or systems whose manufacture, use, or sale is prohibited under any applicable domestic or foreign laws or regulations. You shall comply with any applicable export control laws and regulations promulgated and administered by the governments of any countries asserting jurisdiction over the parties or transactions.
  10. It is the responsibility of the buyer or distributor of Renesas Electronics products, or any other party who distributes, disposes of, or otherwise sells or transfers the product to a third party, to notify such third party in advance of the contents and conditions set forth in this document.
  11. This document shall not be reprinted, reproduced or duplicated in any form, in whole or in part, without prior written consent of Renesas Electronics.
  12. Please contact a Renesas Electronics sales office if you have any questions regarding the information contained in this document or Renesas Electronics products.
- (Note1) "Renesas Electronics" as used in this document means Renesas Electronics Corporation and also includes its directly or indirectly controlled subsidiaries.
- (Note2) "Renesas Electronics product(s)" means any product developed or manufactured by or for Renesas Electronics.

(Rev.4.0-1 November 2017)

## Corporate Headquarters

TOYOSU FORESIA, 3-2-24 Toyosu,  
Koto-ku, Tokyo 135-0061, Japan  
[www.renesas.com](http://www.renesas.com)

## Contact Information

For further information on a product, technology, the most up-to-date version of a document, or your nearest sales office, please visit:  
[www.renesas.com/contact/](http://www.renesas.com/contact/)

## Trademarks

Renesas and the Renesas logo are trademarks of Renesas Electronics Corporation. All trademarks and registered trademarks are the property of their respective owners.

Компания «Life Electronics» занимается поставками электронных компонентов импортного и отечественного производства от производителей и со складов крупных дистрибьюторов Европы, Америки и Азии.

С конца 2013 года компания активно расширяет линейку поставок компонентов по направлению коаксиальный кабель, кварцевые генераторы и конденсаторы (керамические, пленочные, электролитические), за счёт заключения дистрибьюторских договоров

Мы предлагаем:

- Конкурентоспособные цены и скидки постоянным клиентам.
- Специальные условия для постоянных клиентов.
- Подбор аналогов.
- Поставку компонентов в любых объемах, удовлетворяющих вашим потребностям.
- Приемлемые сроки поставки, возможна ускоренная поставка.
- Доставку товара в любую точку России и стран СНГ.
- Комплексную поставку.
- Работу по проектам и поставку образцов.
- Формирование склада под заказчика.
- Сертификаты соответствия на поставляемую продукцию (по желанию клиента).
- Тестирование поставляемой продукции.
- Поставку компонентов, требующих военную и космическую приемку.
- Входной контроль качества.
- Наличие сертификата ISO.

В составе нашей компании организован Конструкторский отдел, призванный помогать разработчикам, и инженерам.

Конструкторский отдел помогает осуществить:

- Регистрацию проекта у производителя компонентов.
- Техническую поддержку проекта.
- Защиту от снятия компонента с производства.
- Оценку стоимости проекта по компонентам.
- Изготовление тестовой платы монтаж и пусконаладочные работы.



Тел: +7 (812) 336 43 04 (многоканальный)  
Email: [org@lifeelectronics.ru](mailto:org@lifeelectronics.ru)