

# RTA Series

## 1-4 Poles Coded Rotary Switches



### Features/Benefits

- PCB or hand soldering versions
- Bushing mounting
- Multiple poles
- Decimal and hexadecimal codes
- Screwdriver slot or extended actuator
- RoHS Compliant

### Typical Applications

- Appliances
- Electronic alarm systems
- Medical
- Building automation
- HVAC air conditioning

### Electrical Data

|                                                                               | Silver            | Gold              |
|-------------------------------------------------------------------------------|-------------------|-------------------|
| SWITCHING MODE:                                                               | BBM               | BBM               |
| MAX. SWITCHING POWER                                                          | 5 VA              | 0.5 VA            |
| MAX. SWITCHING CURRENT:                                                       | 150 mA            | 20 mA             |
| MAX. CARRYING CURRENT:                                                        | 5 A               | 1 A               |
| NOMINAL VOLTAGE AT 50 Hz                                                      | 60 V              | 25 V              |
| CONTACT RESISTANCE:                                                           | < 150 mΩ          | < 150 mΩ          |
| DIELECTRIC STRENGTH AT 50 Hz<br>BETWEEN CONTACTS AND<br>GROUND TERMINALS:     | 500 V r           | 500 V r           |
| INSULATION RESISTANCE BETWEEN<br>CONTACTS OR CONTACTS<br>AND FRAME (500 V ⇒): | 10 <sup>9</sup> Ω | 10 <sup>9</sup> Ω |
| NO. OF OPERATIONS:                                                            | 10,000            | 10,000            |
| BOUNCE:                                                                       | < 5 ms            | < 5 ms            |

### Mechanical Data

MAX. NO. OF BANKS: 1.  
 OPERATING TORQUE: 5 Ncm±20%.  
 END STOP TORQUE: < 60 Ncm.  
 STOP: With/without or adjustable  
 MOUNTING: By fixed index 9.5 mm (0.374) of center, for bushing mount only

### Materials

BUSHING/HOUSING: PETP Thermoplastic  
 STATIONARY CONTACTS & TERMINALS: Nickel Plated Brass with additional plating of Gold or Silver.  
 ROTOR: Gold or Silver plated Brass or PCB.  
 CODING PLATE: PA thermoplastic  
 ACTUATOR: Polysulfon thermoplastic  
 HARDWARE: Stop pin: Aluminum. Ball & Spring: Stainless steel. Washer: PA. Nut: Brass.

### Environmental Data

OPERATING TEMPERATURE: -20°C to + 70°C    -20°C to + 70°C  
 STORAGE TEMPERATURE: -40°C to + 85°C    -40°C to + 85°C

**NOTE:** Specifications and materials listed above are for switches with standard options. For information on specific and custom switches, consult Customer Service Center.

### Build-A-Switch

To order, simply select desired option from each category and place in the appropriate box. Available options are shown and described on pages K-9 thru K-12. For additional options not shown in catalog, consult Customer Service Center.



#### Designation

**RTA**

#### Termination

- P** With PC Thru-hole
- C** With Solder Lugs
- H** Horizontal with PC Thru-hole

#### Switch Function

- 1W12** SP, 30° Index, 12 pos. no stop
- 1W10** SP, 36° Index, 10 pos. no stop
- 1S02** SP, 30° /36° Index, 2 pos.
- 1S03** SP, 30° /36° Index, 3 pos.
- 1S04** SP, 30° /36° Index, 4 pos.
- 1S05** SP, 30° /36° Index, 5 pos.
- 1S06** SP, 30° /36° Index, 6 pos.
- 1S07** SP, 30° /36° Index, 7 pos.
- 1S08** SP, 30° /36° Index, 8 pos.
- 1S09** SP, 30° /36° Index, 9 pos.
- 1S10** SP, 30° /36° Index, 10 pos.
- 1S11** SP, 30° Index, 11 pos.
- 1S12** SP, 30° Index, 12 pos.
- 2S02** DP, 30° /36° Index, 2 pos.
- 2S03** DP, 30° /36° Index, 3 pos.
- 2S04** DP, 30° /36° Index, 4 pos.
- 2S05** DP, 30° /36° Index, 5 pos.
- 2S06** DP, 30° Index, 6 pos.
- 3S02** 3P, 30° /36° Index, 2 pos.

#### Indexing

- 2** 22.5 index (coded only)
- 3** 30° index (12 positions max.)
- 4** 36° index (10 positions max.)

- 3S03** 3P, 30° /36° Index, 3 pos.
- 4S02** 4P, 30° /36° Index, 2 pos.
- EW10** Direct + complement, 36° Index, no stop
- EW12** Direct + complement, 30° Index, no stop
- DW16** Direct, 22.5° Index, no stop
- ES\_\_** Direct + complement, 30°/36° Index, with stop (specify stop position)
- DS\_\_** Direct, 22.5° Index, with stop (specify stop position)

#### Mounting Style

- W** Without bushing
- R** 3/8-32 Threaded Bushing
- M** M10x.75 Metric Threaded Bushing
- A** 3/8-32 Threaded Bushing with Offset Bracket
- B** M10x.75 Metric Threaded Bushing with Offset Bracket

#### Contact Material

- S** Silver plated, matte-tin terminal
- P** Gold plated, matte-tin terminal

#### Actuator (max.)

- 25N** .984 (25,0) with screwdriver slot
- 50N** 1.97 (50,0) with screwdriver slot
- FLS** Flush shaft with screwdriver slot and position indicator
- 25F** .984 (25,0) Shaft with flat
- 06F** .236 (6,0) Shaft with flat

- C** 3/8-32 Threaded Bushing with Straight Bracket
- D** M10x.75 Metric Threaded Bushing with Straight Bracket



Dimensions are shown: Inch (mm)  
 Specifications and dimensions subject to change

# RTA Series 1-4 Poles Coded Rotary Switches

## DESIGNATION

### RTA

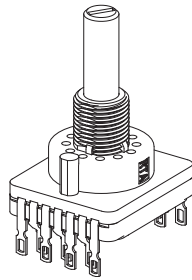

## TERMINATION

### P WITH PC PINS

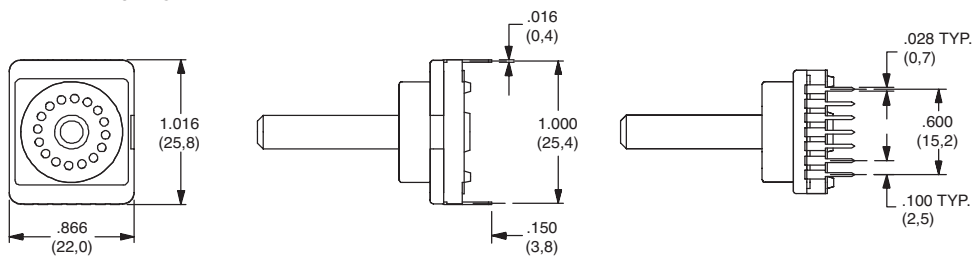

### C WITH SOLDER LUGS

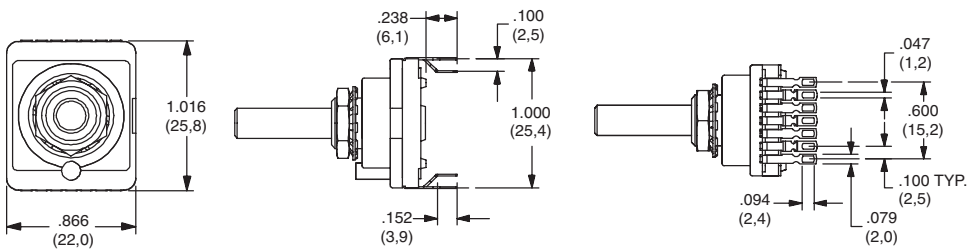

### H Horizontal with PC Thru-hole

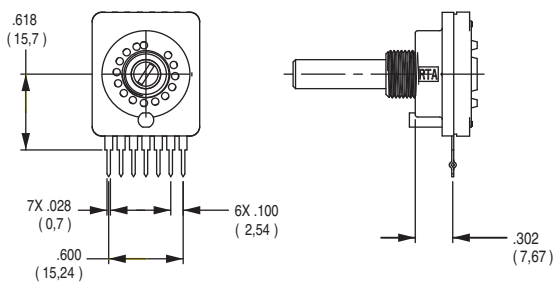

Note: "H" termination only available with the following options:  
 1. With A or B mounting styles  
 2. 36° degree indexing  
 3. Up to 5 positions max

## INDEXING

- 2** 22.5 index, 16 positions max.
- 3** 30 index, 12 positions max.
- 4** 36 index, 10 positions max.

Both commons must be connected by user to ground.



Dimensions are shown: mm  
 Specifications and dimensions subject to change



K

Rotary

# RTA Series 1-4 Poles Coded Rotary Switches

## SWITCH FUNCTION

| NO. POLES | MODEL NO.    | SWITCH FUNCTION      | INDEX   |
|-----------|--------------|----------------------|---------|
| SP        | 1W12         | 12 Positions No Stop | 30°     |
|           | 1W10         | 10 Positions No Stop | 36°     |
|           | 1S02         | 2 Positions          | 30°/36° |
|           | 1S03         | 3 Positions          | 30°/36° |
|           | 1S05         | 5 Positions          | 30°/36° |
|           | 1S06         | 6 Positions          | 30°/36° |
|           | 1S08         | 8 Positions          | 30°/36° |
|           | 1S09         | 9 Positions          | 30°/36° |
|           | 1S10         | 10 Positions         | 30°/36° |
|           | 1S11         | 11 Positions         | 30°     |
| 1S12      | 12 Positions | 30°                  |         |

SP MODELS SCHEMATIC

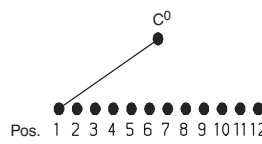

3P MODELS SCHEMATIC

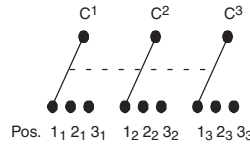

DP MODELS SCHEMATIC

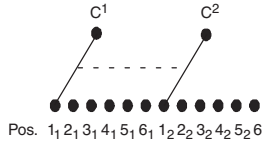

4P MODELS SCHEMATIC

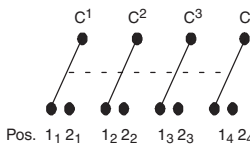

| NO. POLES | MODEL NO. | SWITCH FUNCTION     | INDEX   |
|-----------|-----------|---------------------|---------|
| DP        | 2W05      | 5 Positions No Stop | 30°/36° |
|           | 2W06      | 6 Positions No Stop | 30°     |
|           | 2S02      | 2 Positions         | 30°/36° |
|           | 2S03      | 3 Positions         | 30°/36° |
|           | 2S04      | 4 Positions         | 30°/36° |
|           | 2S05      | 5 Positions         | 30°/36° |
| 3P        | 3S02      | 2 Positions         | 30°/36° |
|           | 3S03      | 3 Positions         | 30°/36° |
| 4P        | 4S02      | 2 Positions         | 30°/36° |

| MODEL NO. | SWITCH FUNCTION                                        | INDEX     |
|-----------|--------------------------------------------------------|-----------|
| EW10      | Direct + complement, No stop                           | 36°       |
| EW12      | Direct + complement, No stop                           | 30°       |
| DW16      | Direct, No stop                                        | 22.5°     |
| ES__      | Direct + complement, with stop (specify stop position) | 30° & 36° |
| DS__      | Direct, with stop (specify stop position)              | 22.5°     |

| 22.5° | 30° | 36° |   | Pos. | 1 | 2 | 3 | 4 | 5 | 6 | 7 | 8 | 9 | 10 | 11 | 12 | 13 | 14 | 15 | 16 |   |
|-------|-----|-----|---|------|---|---|---|---|---|---|---|---|---|----|----|----|----|----|----|----|---|
| E,J   | M,N | L,N | C |      | • | • | • | • | • | • | • | • | • | •  | •  | •  | •  | •  | •  | •  | • |
| F,I   | H   | D   | 1 |      |   | • |   | • |   | • |   | • |   | •  |    | •  |    | •  |    | •  |   |
| D,K   | D   | B   | 2 |      |   |   | • | • |   |   | • | • |   |    | •  | •  |    |    | •  | •  |   |
| A,N   | A   | I   | 4 |      |   |   |   | • | • | • | • |   |   |    |    | •  | •  | •  | •  |    |   |
| B     | J   | J   | 8 |      |   |   |   |   |   |   |   |   | • | •  | •  | •  | •  | •  | •  | •  |   |
| -     | C   | K   | 1 |      | • |   | • |   | • |   | • |   | • |    | •  |    | •  |    | •  |    |   |
| -     | K   | H   | 2 |      | • | • |   |   | • | • |   |   | • | •  |    | •  | •  |    | •  |    |   |
| -     | B   | A   | 4 |      | • | • | • | • |   |   |   |   | • | •  |    | •  |    |    | •  |    |   |
| -     | I   | C   | 8 |      | • | • | • | • | • | • | • | • |   |    |    |    |    |    |    |    |   |

### Indexing Option Code 2, 22.5 INDEXING ANGLE PCB LAYOUT

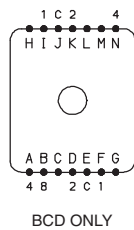

### Indexing Option Code 3, 30 INDEXING ANGLE PCB LAYOUT

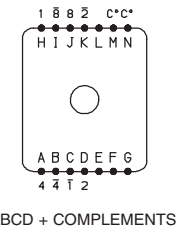
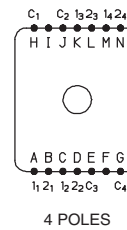
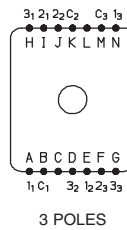
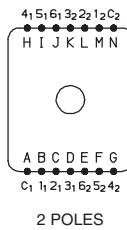
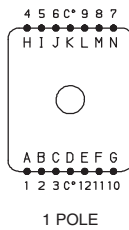

### Indexing Option Code 4, 36 INDEXING ANGLE PCB LAYOUT

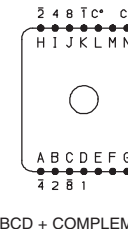
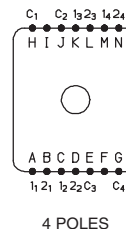
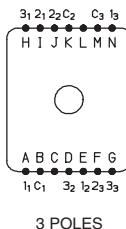
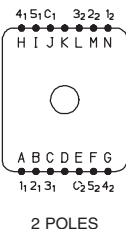
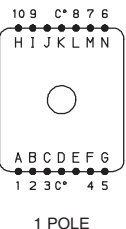

**NOTE:** Layout view from component side.

Common terminals that are in locations A-G are not connected to common terminals that are in locations H-N. For 7-12 position output customer must tie these commons together.

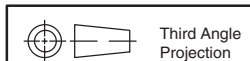

Third Angle Projection

Dimensions are shown: Inch (mm)  
Specifications and dimensions subject to change



# RTA Series 1-4 Poles Coded Rotary Switches

## MOUNTING STYLE

### W WITHOUT BUSHING

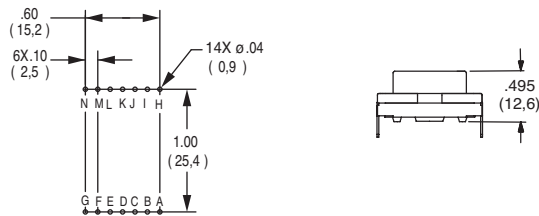

Note: W mounting style not available with H termination.

### M M10 x .75 METRIC THREADED BUSHING

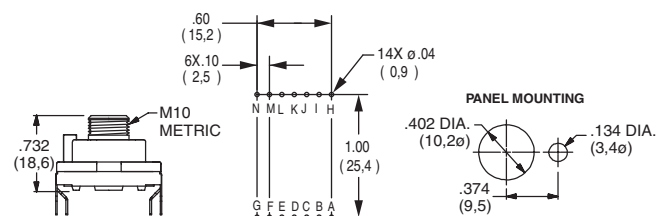

Note: M mounting style not available with H termination.

### R 3/8-32 THREADED BUSHING

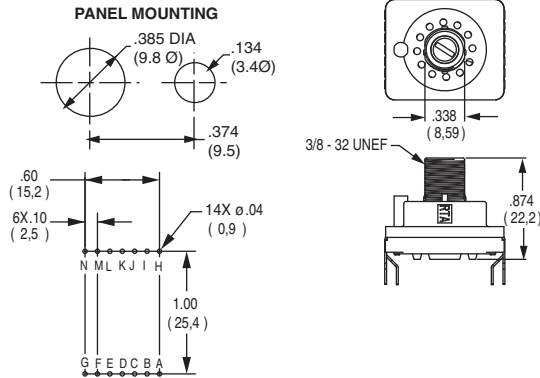

Note: R mounting style not available with H termination.

### A 3/8-32 THREADED BUSHING WITH BRACKET

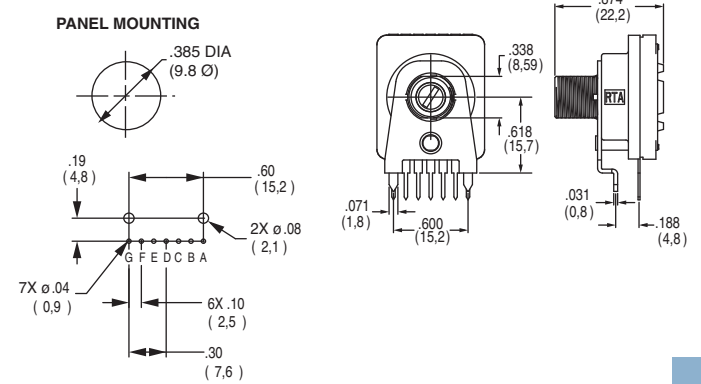

Note: A mounting style only available with H termination.

### B M10 x .75 METRIC THREADED BUSHING WITH BRACKET

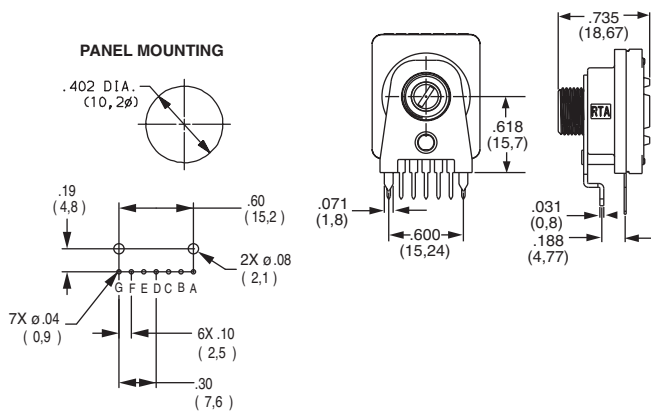

Note: B mounting style only available with H termination.

### C 3/8-32 THREADED BUSHING WITH STRAIGHT BRACKET

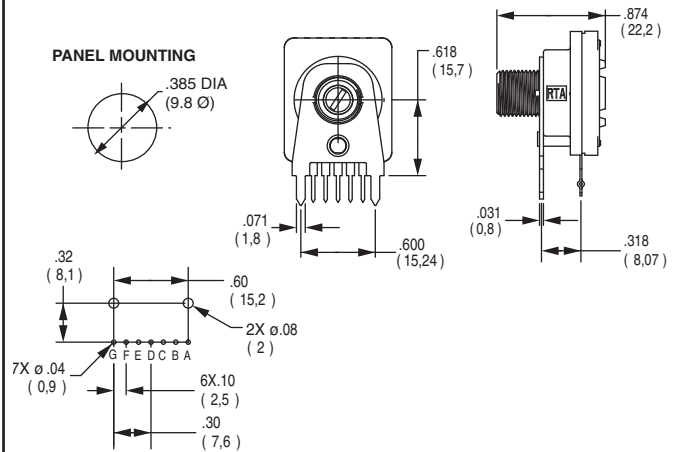

### D M10 x .75 METRIC THREADED BUSHING WITH STRAIGHT BRACKET

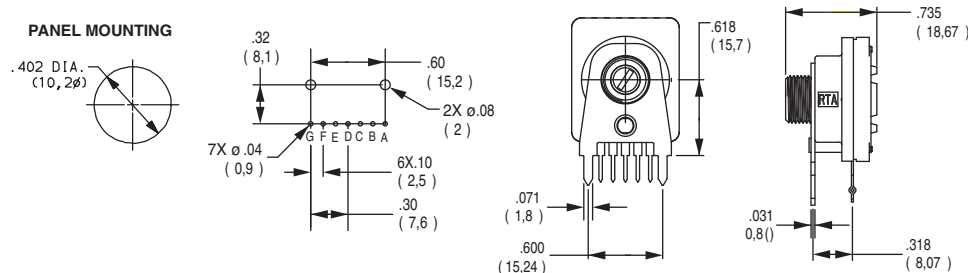

Third Angle Projection  
Dimensions are shown: mm  
Specifications and dimensions subject to change



K

Rotary

# RTA Series 1-4 Poles Coded Rotary Switches

## ACTUATOR

**25N** .984 (25,0) WITH SCREWDRIVER SLOT

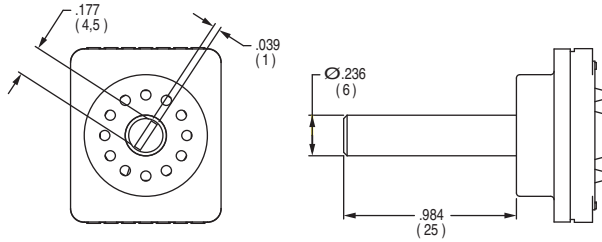

**50N** 1.97 (50,0) WITH SCREWDRIVER SLOT

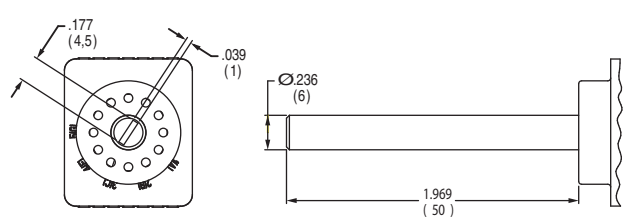

**FLS** FLUSH SHAFT WITH SCREWDRIVER SLOT AND POSITION INDICATOR

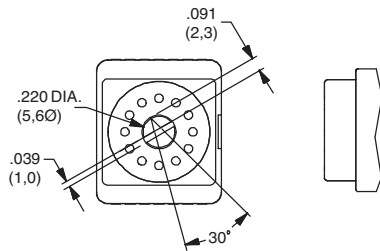

Note: only available with "W" Mounting Style

**25F** .984 (25,0) SHAFT WITH FLAT

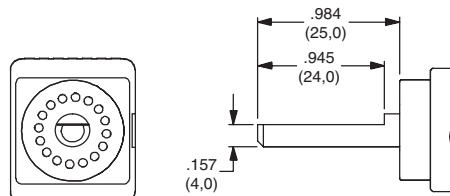

Note: only available with "W" Mounting Style

**06F** .236 (6,0) SHAFT WITH FLAT

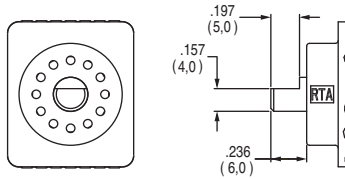

Note: only available with "W" Mounting Style

## CONTACT MATERIAL

| OPTION CODE | CONTACT AND TERMINAL MATERIAL | RATING                         |                                                                                      |
|-------------|-------------------------------|--------------------------------|--------------------------------------------------------------------------------------|
| <b>S</b>    | SILVER                        | LOW LEVEL/DRY CIRCUIT          | SWITCH: 150 mA MAXIMUM, 60 V NOMINAL.<br>POWER: 5 VA MAXIMUM. CARRY-5 AMPS MAXIMUM.  |
| <b>P</b>    | GOLD                          | LOW LEVEL/DRY CIRCUIT OR POWER | SWITCH: 20 mA MAXIMUM, 25 V NOMINAL.<br>POWER: 0.5 VA MAXIMUM. CARRY: 1 AMP MAXIMUM. |

\* Note: See Technical Data section of this catalog for RoHS compliant and compatible definition and specifications.

## AVAILABLE HARDWARE

### Mounting Nuts

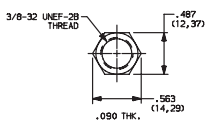

PART NO.  
**472706201**  
Standard

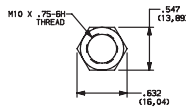

PART NO.  
**495100201**  
Metric

### Stop pins



PART NO.  
**Y200300200P**

### Lockwasher

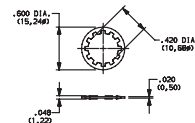

PART NO.  
**472800202**

NOTE: Additional nuts and lockwashers available separately, see section "Technical Data and Additional Hardware".



Third Angle  
Projection

Dimensions are shown: Inch (mm)  
Specifications and dimensions subject to change

**C&K**

Компания «Life Electronics» занимается поставками электронных компонентов импортного и отечественного производства от производителей и со складов крупных дистрибьюторов Европы, Америки и Азии.

С конца 2013 года компания активно расширяет линейку поставок компонентов по направлению коаксиальный кабель, кварцевые генераторы и конденсаторы (керамические, пленочные, электролитические), за счёт заключения дистрибьюторских договоров

Мы предлагаем:

- Конкурентоспособные цены и скидки постоянным клиентам.
- Специальные условия для постоянных клиентов.
- Подбор аналогов.
- Поставку компонентов в любых объемах, удовлетворяющих вашим потребностям.
- Приемлемые сроки поставки, возможна ускоренная поставка.
- Доставку товара в любую точку России и стран СНГ.
- Комплексную поставку.
- Работу по проектам и поставку образцов.
- Формирование склада под заказчика.
- Сертификаты соответствия на поставляемую продукцию (по желанию клиента).
- Тестирование поставляемой продукции.
- Поставку компонентов, требующих военную и космическую приемку.
- Входной контроль качества.
- Наличие сертификата ISO.

В составе нашей компании организован Конструкторский отдел, призванный помогать разработчикам, и инженерам.

Конструкторский отдел помогает осуществить:

- Регистрацию проекта у производителя компонентов.
- Техническую поддержку проекта.
- Защиту от снятия компонента с производства.
- Оценку стоимости проекта по компонентам.
- Изготовление тестовой платы монтаж и пусконаладочные работы.



Тел: +7 (812) 336 43 04 (многоканальный)

Email: [org@lifeelectronics.ru](mailto:org@lifeelectronics.ru)