

885017

2436 MHz BAW Filter

Applications

- WiFi bandpass filter that enables the coexistence of 4G (WiMAX/LTE/TD-LTE) & WiFi signals
- Handsets
- Portable Hotspots
- Mobile Routers
- Smart Meters
- High-power WLAN Access Points
- Applicable reject bands: 2.6 GHz WiMAX/LTE, 2.3GHz WiMAX/LTE, LTE Bands 7 & 38, TD-LTE Band 40, WCS, WiBro, Indian 2.3GHz 4G band

Product Features

- Low Loss in WLAN band w/ extended upper corner for inclusion of Bluetooth
- High Rejection in 2300-2380 MHz bands: WiMAX/WCS/WiBro/Band 40/Indian 4G band
- Industry-leading small size: 1.4 x 1.2 x 0.46 mm
- +28 dBm (CW) power handling
- Performance over -30 to +85 °C
- Single-ended operation
- Ceramic chip-scale package (CSP)
- Hermetically Sealed
- RoHS compliant, Pb-free

General Description

885017 is a high-performance, high-power Bulk Acoustic Wave (BAW) bandpass filter with extremely steep skirts, simultaneously exhibiting low loss in the WiFi band & high near-in rejection in the 2.3GHz & 2.6GHz WiMAX/LTE/TD-LTE bands.

885017 is specifically designed to enable coexistence of WiFi and WiMAX/LTE signals within the same device or in close proximity to one another.

885017 uses advanced and inexpensive packaging techniques to achieve an industry-leading 1.4 x 1.2 x 0.46 mm package. The filter exhibits excellent power handling capabilities.

885017 is referenced on multiple designs with the leading WiMAX chipset makers

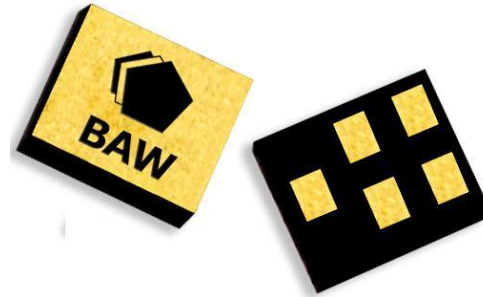

1.4 x 1.2 x 0.46 mm

Functional Block Diagram

Top view

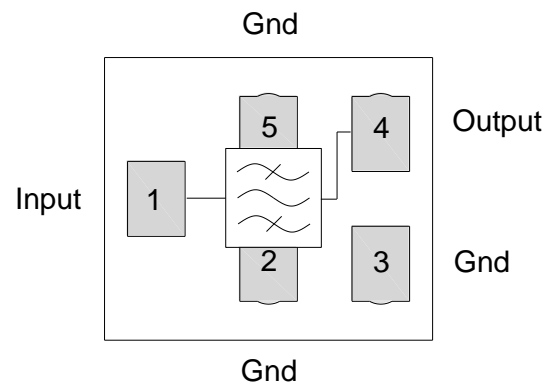

Pin Configuration

Pin #	SE	Description
1		Input
4		Output
2,3,5		Case Ground

Ordering Information

Part No.	Description
885017	packaged part
885017-EVB	evaluation board

Standard T/R size = 10,000 units/reel.

Specifications

Electrical Specifications ⁽¹⁾

Specified Temperature Range: ⁽²⁾ -30 to + 85 °C (unless otherwise noted)

Parameter	Conditions	Min	Typical ⁽³⁾	Max	Units
Center Frequency		-	2436	-	MHz
Maximum Insertion Loss	2400 - 2472 MHz @ 25 °C	-	1.8	2.5	dB
	2400 - 2472 MHz -30 to +85 °C	-	-	3.5	dB
	2401 - 2480 MHz -30 to +55 °C	-	2.5	3.5	dB
	2401 - 2480 MHz +55 to +85 °C	-	2.5	5.0	dB
	2480 - 2482 MHz ⁽⁶⁾ +25 °C	-	3.0	5.0	dB
Absolute Attenuation ⁽⁴⁾	800 - 2000 MHz	22	25	-	dB
	2000 - 2300 MHz	24	26	-	dB
	2300 - 2360 MHz	25	36	-	dB
	2360 - 2370 MHz ⁽⁶⁾	15	20	-	dB
	2370 - 2380 MHz ⁽⁶⁾	5	8	-	dB
	2496 - 2502 MHz ⁽⁷⁾	-	20	-	dB ave
	2500 - 2502 MHz	-	30	-	dB
	2500 - 2510 MHz ⁽⁷⁾	-	45	-	dB ave
	2502 - 2690 MHz	25	30	-	dB
	2690 - 5000 MHz	25	28	-	dB
	7200 - 7416 MHz	-	14	-	dB
Amplitude Ripple	2400 - 2472 MHz (within any 18MHz Channel)	-	1.3	2.0	dB p-p
Input/output Return Loss	2400 - 2472MHz	6.0	10	-	dB
Source Impedance (single-ended) ⁽⁵⁾		-	50	-	Ω
Load Impedance (single-ended) ⁽⁵⁾		-	50	-	Ω

Notes:

- All specifications are based on the TriQuint schematic for the main reference design shown on page 3
- In production, devices will be tested at room temperature to a guardbanded specification to ensure electrical compliance over temperature
- Typical values are based on average measurements at room temperature
- Relative to zero dB
- This is the optimum impedance in order to achieve the performance shown
- These bands fall on the filter transitions, thus the typical attenuation/loss values given are prone to high variability
- Average attenuation level over the band

Absolute Maximum Ratings

Parameter ⁽⁸⁾	Rating
Operating Temperature	-30 to +85 °C
Storage Temperature	-40 to +85 °C
Input Power ⁽⁹⁾ (In passband, CW signal)	+28 dBm

- Operation of this device outside the parameter ranges given above may cause permanent damage.
- Represents the maximum allowable power level without electrical degradation equivalent to duration of 10,000 hours at 55°C

Reference Design – 50Ω SE Input, 50Ω SE Output

Schematic (top view)

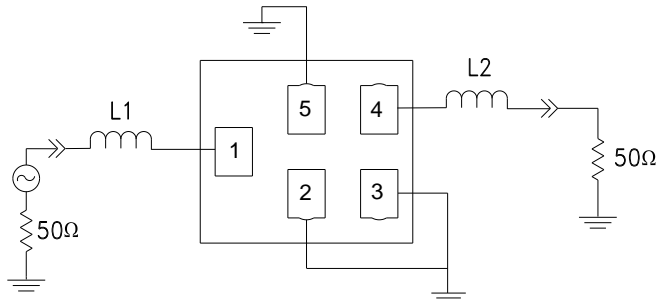

1. Notes:
 Actual matching values may vary due to PCB layout and parasitic

Pin Functions

Pin #	Description
1	Input
4	Output
2,3,5	Ground

PC Board

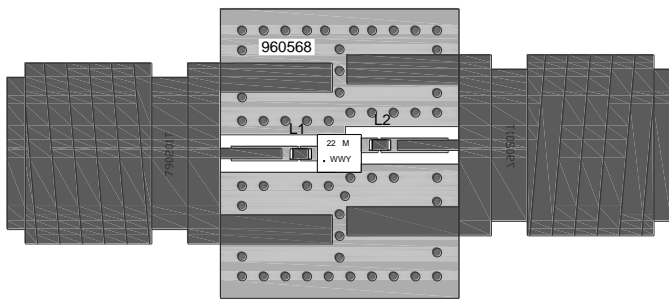

Notes:
 Top, middle & bottom layers: 1 oz copper
 Substrates: FR4 dielectric, .031” thick
 Finish plating: Nickel: 3-8μm thick, Gold: .03-.2μm thick
 Hole plating: Copper min .0008μm thick

PCB routing detail

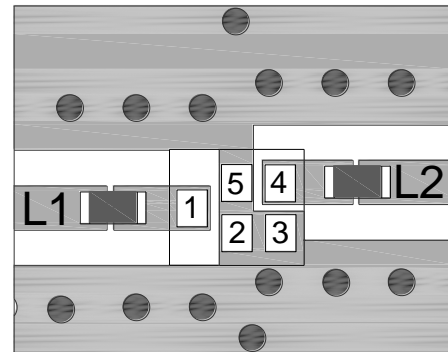

Notes:
 1. Grey indicates metalized area
 2. This footprint represents a recommendation only
 3. For solder pad recommendation see mechanical information

Bill of Material

Reference Desg.	Value	Description	Manufacturer	Part Number
L1	1.5nH	Chip Inductor, 0402, +/- 0.2nH	MuRata	LQG15HN1N5S02
L2	1.5nH	Chip Inductor, 0402, +/- 0.2nH	MuRata	LQG15HN1N5S02
PCB	N/A	3-layer	multiple	960568

Typical Performance (at room temperature)

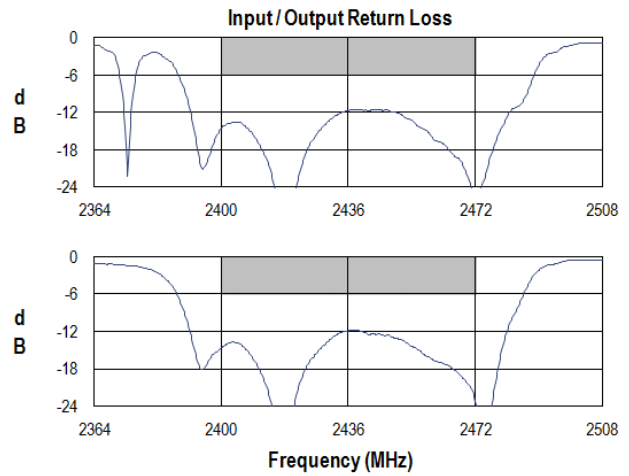
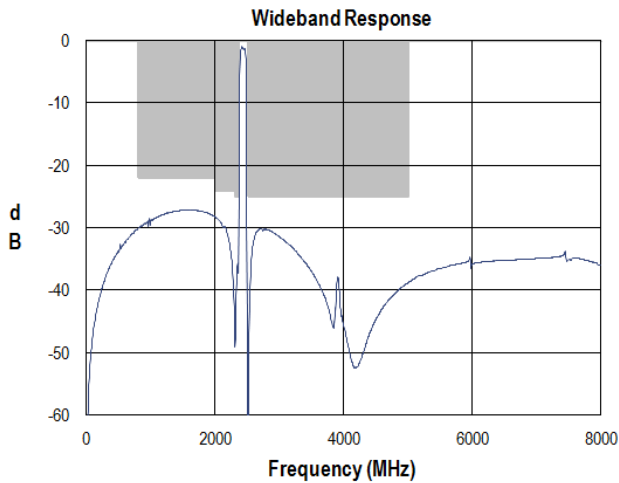
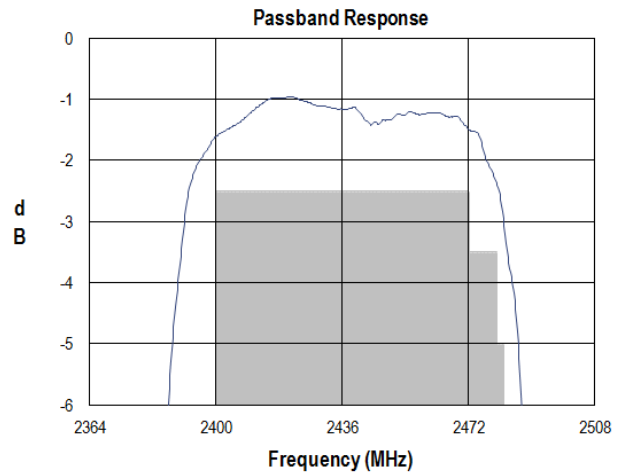
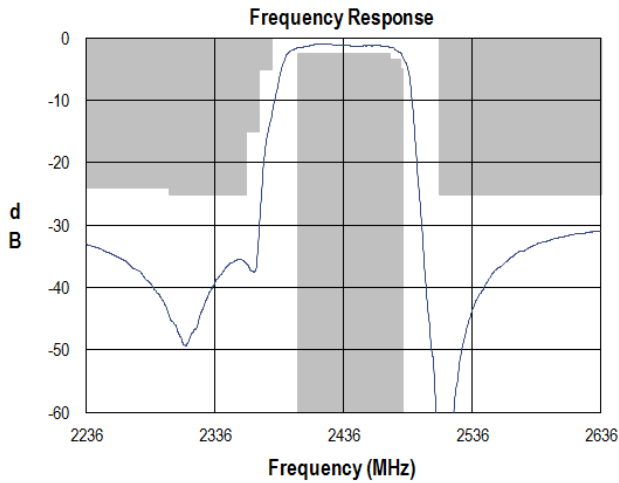

Input Smith Chart

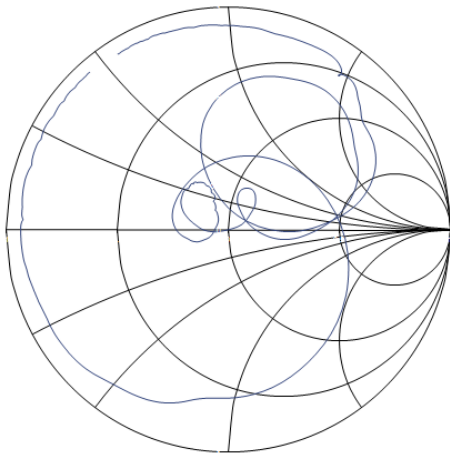

Output Smith Chart

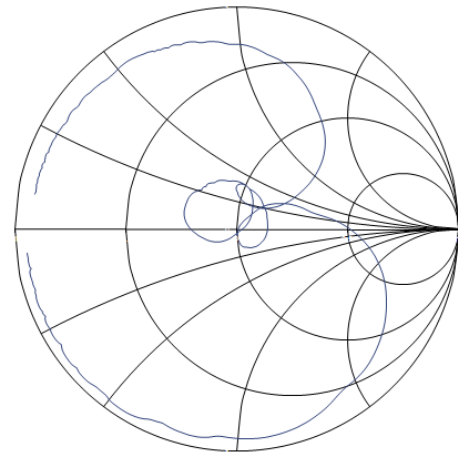

Mechanical Information

Package Information, Dimensions and Marking

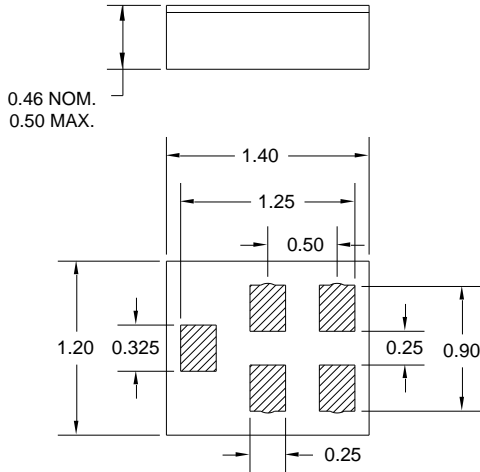

Package Style: CSP-5BT
 Dimensions: 1.4 x 1.2 x 0.46 mm

Body: Al_2O_3 ceramic
 Lid: Kovar or Alloy 42, Au over Ni plated
 Terminations: Au plating 0.5 - 1.0 μ m, over a 2-6 μ m Ni plating

All dimensions shown are nominal in millimeters
 All tolerances are ± 0.15 mm except overall length and width ± 0.10 mm

Marking

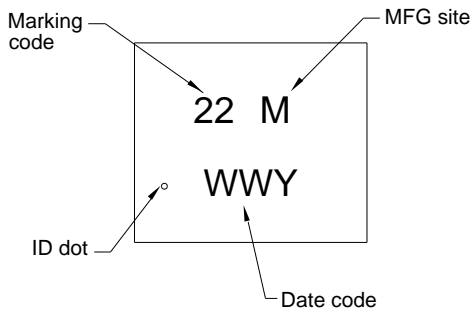

The date code consists of: WW = 2 digit week,
 Y = last digit of year, M = manufacturing site code

PCB Footprint

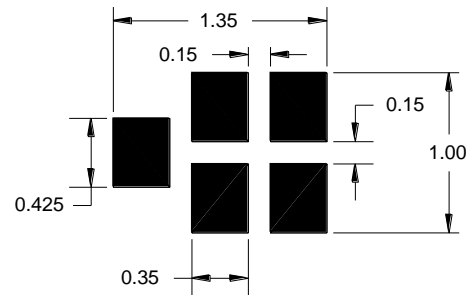

Tape and Reel Information

Standard T/R size = 10,000 units/reel. All dimensions are in millimeters

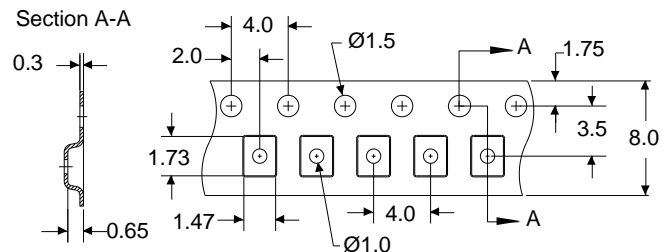
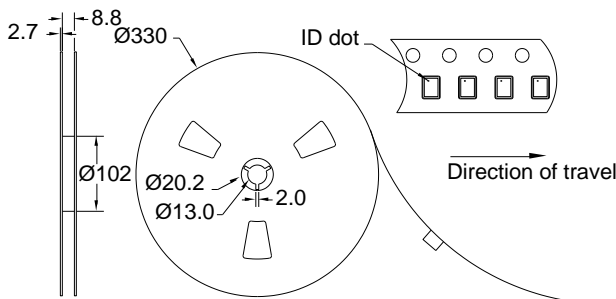

Product Compliance Information

ESD Information



Caution! ESD-Sensitive Device

ESD Rating: 1C

Value: Passes ≥ 1600 V min.
Test: Human Body Model (HBM)
Standard: JEDEC Standard JESD22-A114

ESD Rating: B

Value: Passes ≥ 350 V min.
Test: Machine Model (MM)
Standard: JEDEC Standard JESD22-A115

MSL Rating

Devices are hermetic, therefore MSL is not applicable.

Solderability

Compatible with the latest version of J-STD-020, lead free solder, 260°C

Refer to [Soldering Profile](#) for recommended guidelines.

This part is compliant with EU 2002/95/EC RoHS directive (Restrictions on the Use of Certain Hazardous Substances in Electrical and Electronic Equipment).

This product also has the following attributes:

- Halogen Free (Chlorine, Bromine)
- Antimony Free
- TBBP-A (C₁₅H₁₂Br₄O₂) Free
- PFOS Free
- SVHC Free

Contact Information

For the latest specifications, additional product information, worldwide sales and distribution locations, and information about TriQuint:

Web: www.triquint.com Tel: +1.407.886.8860
Email: info-sales@tqs.com Fax: +1.407.886.7061

For technical questions and application information:

Email: flapplication.engineering@tqs.com

Important Notice

The information contained herein is believed to be reliable. TriQuint makes no warranties regarding the information contained herein. TriQuint assumes no responsibility or liability whatsoever for any of the information contained herein. TriQuint assumes no responsibility or liability whatsoever for the use of the information contained herein. The information contained herein is provided "AS IS, WHERE IS" and with all faults, and the entire risk associated with such information is entirely with the user. All information contained herein is subject to change without notice. Customers should obtain and verify the latest relevant information before placing orders for TriQuint products. The information contained herein or any use of such information does not grant, explicitly or implicitly, to any party any patent rights, licenses, or any other intellectual property rights, whether with regard to such information itself or anything described by such information.

TriQuint products are not warranted or authorized for use as critical components in medical, life-saving, or life-sustaining applications, or other applications where a failure would reasonably be expected to cause severe personal injury or death.

Компания «Life Electronics» занимается поставками электронных компонентов импортного и отечественного производства от производителей и со складов крупных дистрибьюторов Европы, Америки и Азии.

С конца 2013 года компания активно расширяет линейку поставок компонентов по направлению коаксиальный кабель, кварцевые генераторы и конденсаторы (керамические, пленочные, электролитические), за счёт заключения дистрибьюторских договоров

Мы предлагаем:

- Конкурентоспособные цены и скидки постоянным клиентам.
- Специальные условия для постоянных клиентов.
- Подбор аналогов.
- Поставку компонентов в любых объемах, удовлетворяющих вашим потребностям.
- Приемлемые сроки поставки, возможна ускоренная поставка.
- Доставку товара в любую точку России и стран СНГ.
- Комплексную поставку.
- Работу по проектам и поставку образцов.
- Формирование склада под заказчика.
- Сертификаты соответствия на поставляемую продукцию (по желанию клиента).
- Тестирование поставляемой продукции.
- Поставку компонентов, требующих военную и космическую приемку.
- Входной контроль качества.
- Наличие сертификата ISO.

В составе нашей компании организован Конструкторский отдел, призванный помогать разработчикам, и инженерам.

Конструкторский отдел помогает осуществить:

- Регистрацию проекта у производителя компонентов.
- Техническую поддержку проекта.
- Защиту от снятия компонента с производства.
- Оценку стоимости проекта по компонентам.
- Изготовление тестовой платы монтаж и пусконаладочные работы.



Тел: +7 (812) 336 43 04 (многоканальный)

Email: org@lifeelectronics.ru