

MECHANICAL DATA

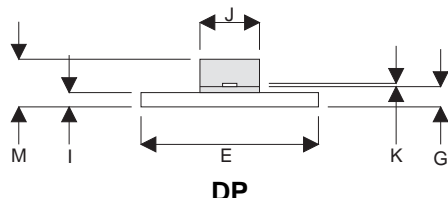
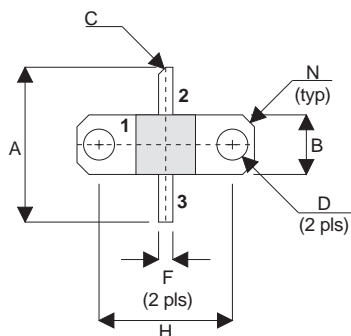

PIN 1 SOURCE
 PIN 3 GATE

PIN 2 DRAIN

DIM	mm	Tol.	Inches	Tol.
A	16.51	0.25	0.650	0.010
B	6.35	0.13	0.250	0.005
C	45°	5°	45°	5°
D	3.30	0.13	0.130	0.005
E	18.92	0.08	0.745	0.003
F	1.52	0.13	0.060	0.005
G	2.16	0.13	0.085	0.005
H	14.22	0.08	0.560	0.003
I	1.52	0.13	0.060	0.005
J	6.35	0.13	0.250	0.005
K	0.13	0.03	0.005	0.001
M	5.08	0.51	0.200	0.020
N	1.27 x 45°	0.13	0.050 x 45°	0.005

GOLD METALLISED MULTI-PURPOSE SILICON DMOS RF FET 2.5W – 28V – 1GHz SINGLE ENDED

FEATURES

- SIMPLIFIED AMPLIFIER DESIGN
- SUITABLE FOR BROAD BAND APPLICATIONS
- LOW C_{rss}
- SIMPLE BIAS CIRCUITS
- LOW NOISE
- HIGH GAIN – 13 dB MINIMUM

APPLICATIONS

- VHF/UHF COMMUNICATIONS
 from 50 MHz to 1 GHz

ABSOLUTE MAXIMUM RATINGS ($T_{case} = 25^{\circ}C$ unless otherwise stated)

P_D	Power Dissipation	17.5W
BV_{DSS}	Drain – Source Breakdown Voltage	65V
BV_{GSS}	Gate – Source Breakdown Voltage	$\pm 20V$
$I_{D(sat)}$	Drain Current	1A
T_{stg}	Storage Temperature	-65 to $150^{\circ}C$
T_j	Maximum Operating Junction Temperature	$200^{\circ}C$

Semelab Plc reserves the right to change test conditions, parameter limits and package dimensions without notice. Information furnished by Semelab is believed to be both accurate and reliable at the time of going to press. However Semelab assumes no responsibility for any errors or omissions discovered in its use. Semelab encourages customers to verify that datasheets are current before placing orders.

ELECTRICAL CHARACTERISTICS (T_{case} = 25°C unless otherwise stated)

Parameter	Test Conditions	Min.	Typ.	Max.	Unit
B _V DSS Drain–Source Breakdown Voltage	V _{GS} = 0 I _D = 10mA	65			V
I _D DSS Zero Gate Voltage Drain Current	V _{DS} = 28V V _{GS} = 0			1	mA
I _G DSS Gate Leakage Current	V _{GS} = 20V V _{DS} = 0			1	μA
V _{GS(th)} Gate Threshold Voltage*	I _D = 10mA V _{DS} = V _{GS}	1		7	V
g _{fs} Forward Transconductance*	V _{DS} = 10V I _D = 0.2A	0.18			S
G _{PS} Common Source Power Gain	P _O = 2.5W	13			dB
η Drain Efficiency	V _{DS} = 28V I _{DQ} = 0.1A	40			%
VSWR Load Mismatch Tolerance	f = 1GHz	20:1			—
C _{iss} Input Capacitance	V _{DS} = 28V V _{GS} = -5V f = 1MHz			12	pF
C _{oss} Output Capacitance	V _{DS} = 28V V _{GS} = 0 f = 1MHz			6	pF
C _{rss} Reverse Transfer Capacitance	V _{DS} = 28V V _{GS} = 0 f = 1MHz			0.5	pF

* Pulse Test: Pulse Duration = 300 μs , Duty Cycle ≤ 2%

HAZARDOUS MATERIAL WARNING

The ceramic portion of the device between leads and metal flange is beryllium oxide. Beryllium oxide dust is highly toxic and care must be taken during handling and mounting to avoid damage to this area.

THESE DEVICES MUST NEVER BE THROWN AWAY WITH GENERAL INDUSTRIAL OR DOMESTIC WASTE.

THERMAL DATA

R _{THj-case}	Thermal Resistance Junction – Case	Max. 10°C / W
-----------------------	------------------------------------	---------------

Semelab Plc reserves the right to change test conditions, parameter limits and package dimensions without notice. Information furnished by Semelab is believed to be both accurate and reliable at the time of going to press. However Semelab assumes no responsibility for any errors or omissions discovered in its use. Semelab encourages customers to verify that datasheets are current before placing orders.

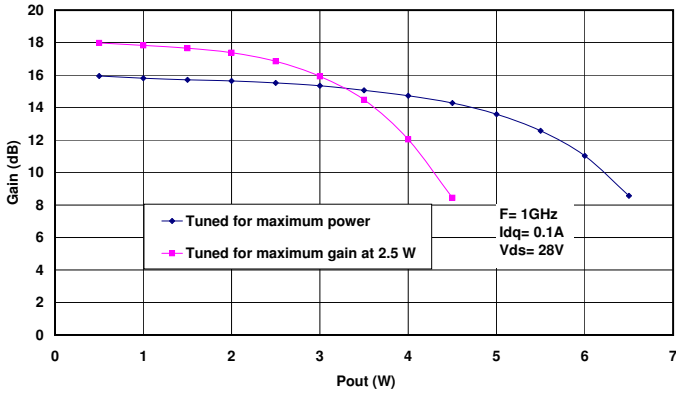

Figure 1
Gain vs. Output Power.

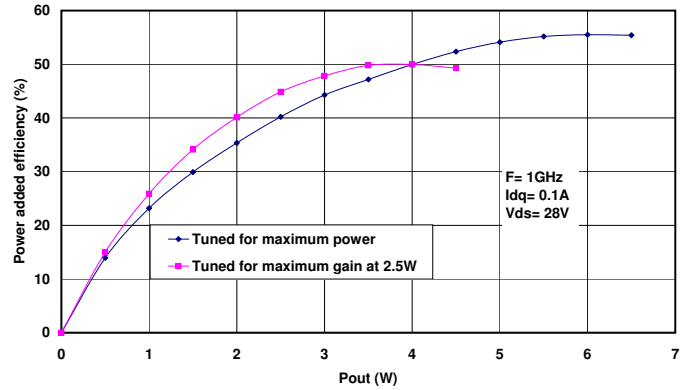

Figure 2
Power added efficiency vs. Output Power.

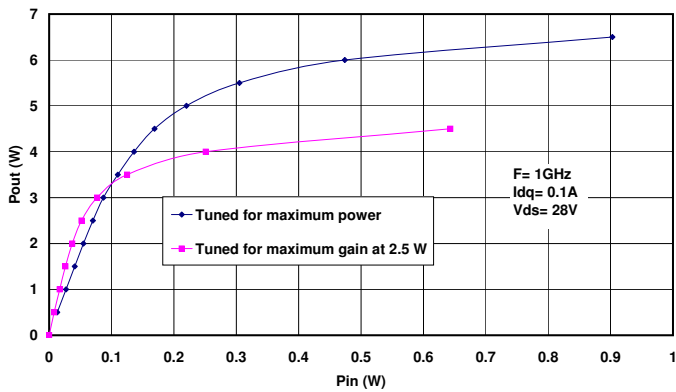

Figure 3
Output Power vs. Input Power.

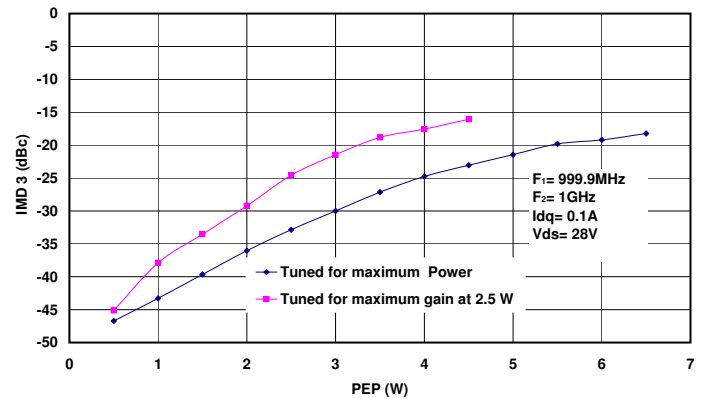

Figure 4
IMD 3 vs. PEP

Typical S Parameters

! Vds=28V, Idq=0.1A
MHz S MA R 50

!Freq !MHz	S11 mag	ang	S21 mag	ang	S12 mag	ang	S22 mag	ang
100	0.966	-47	16.778	144	0.01479	56	0.923	-28
200	0.891	-81	12.882	118	0.02114	34	0.841	-48
300	0.841	-103	9.772	99	0.02213	20	0.794	-62
400	0.804	-120	7.674	84	0.01995	11	0.759	-73
500	0.804	-134	6.237	69	0.01641	6	0.75	-86
600	0.804	-143	4.955	59	0.01175	9	0.767	-97
700	0.822	-147	4.121	54	0.00906	41	0.776	-101
800	0.822	-154	3.631	45	0.01109	73	0.813	-107
900	0.841	-162	3.162	36	0.01718	88	0.813	-116
1000	0.832	-168	2.6	30	0.02344	94	0.804	-122

Semelab Plc reserves the right to change test conditions, parameter limits and package dimensions without notice. Information furnished by Semelab is believed to be both accurate and reliable at the time of going to press. However Semelab assumes no responsibility for any errors or omissions discovered in its use. Semelab encourages customers to verify that datasheets are current before placing orders.

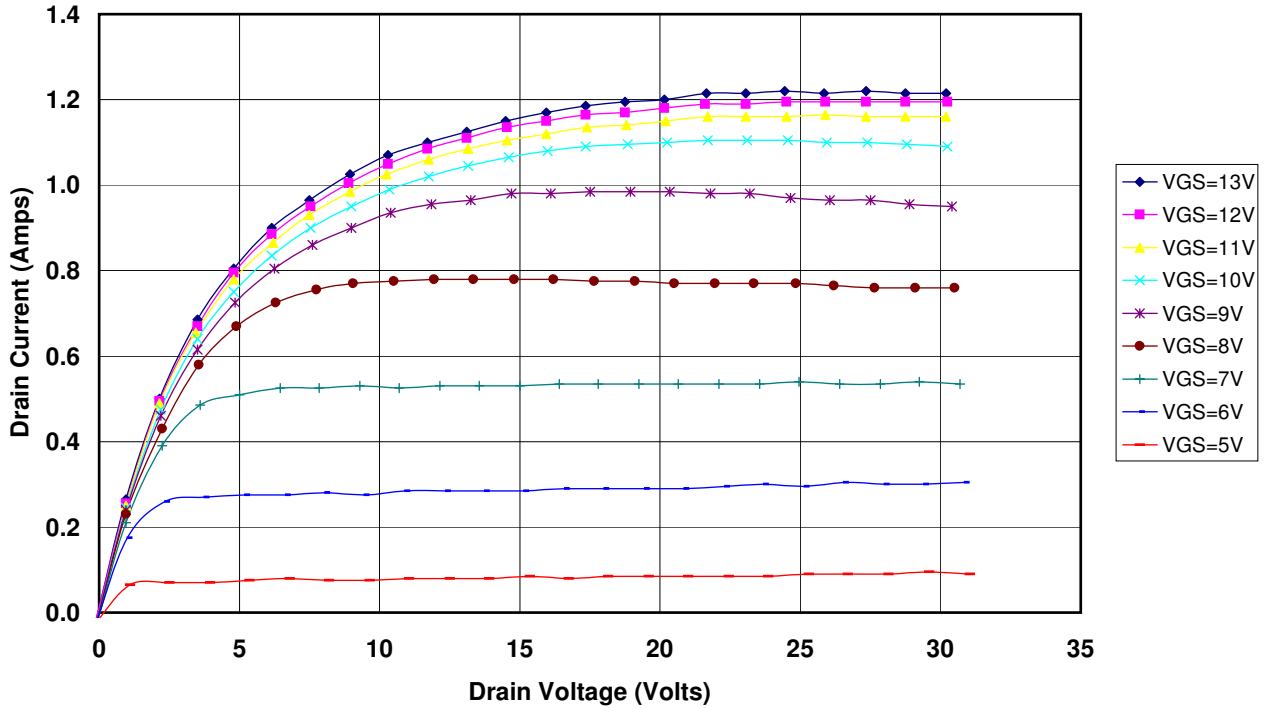

Figure 5 – Typical IV Characteristics.

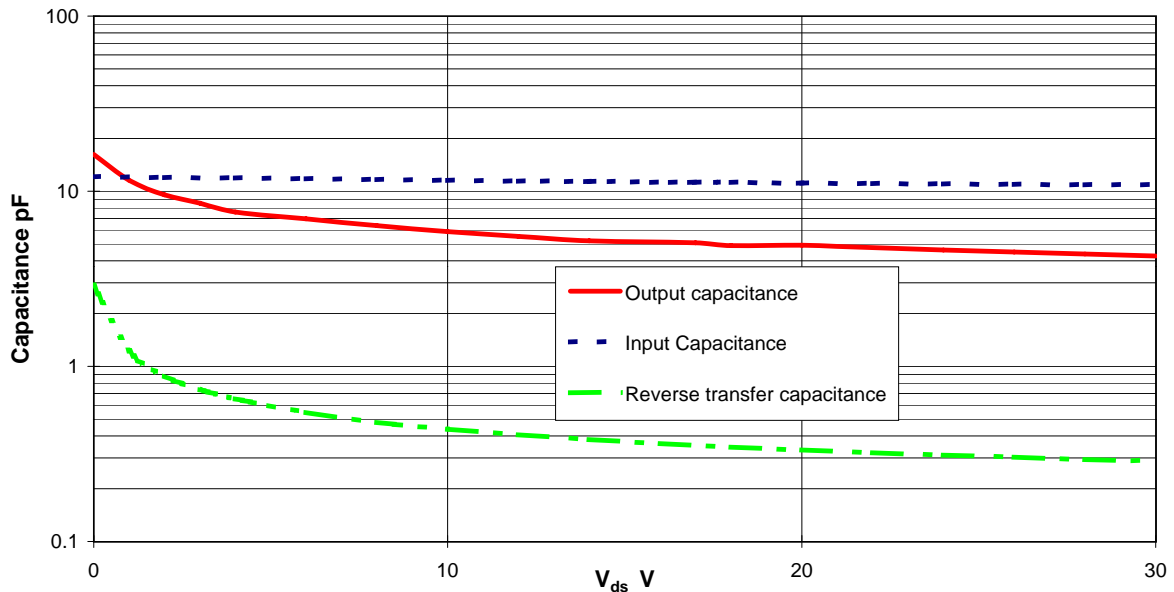
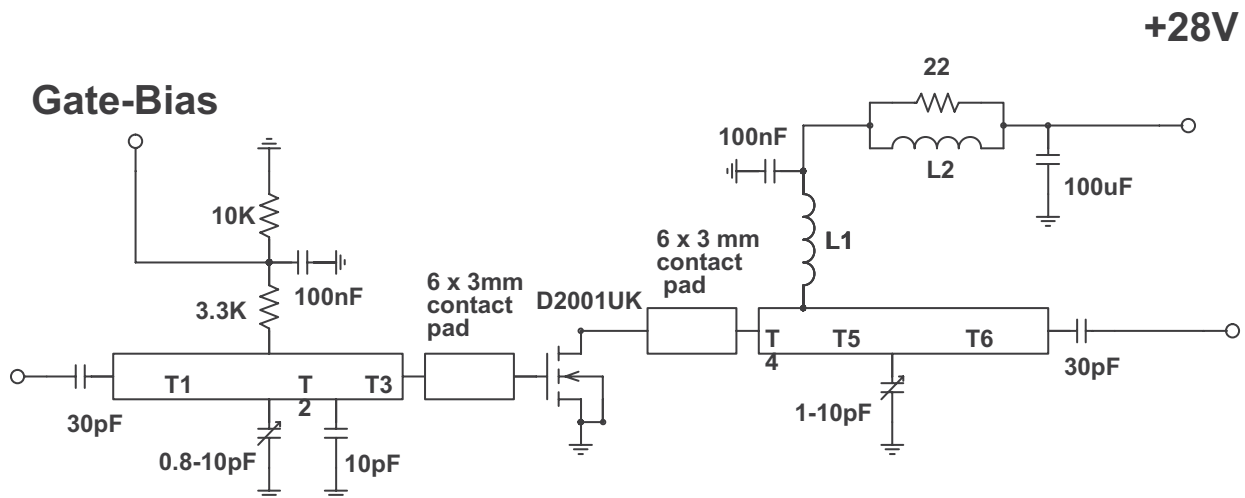

Figure 6 – Typical CV Characteristics.

Semelab Plc reserves the right to change test conditions, parameter limits and package dimensions without notice. Information furnished by Semelab is believed to be both accurate and reliable at the time of going to press. However Semelab assumes no responsibility for any errors or omissions discovered in its use. Semelab encourages customers to verify that datasheets are current before placing orders.



D2001UK 1GHz TEST FIXTURE

Substrate 0.8mm PTFE/glass, $\epsilon_r = 2.5$
 All microstrip lines $W = 2.4\text{mm}$

T1	35 mm
T2, T5	15 mm
T3	3 mm
T4	4 mm
T6	32 mm

L1	7 turns 24swg enamelled copper wire, 3mm i.d.
L2	1.5 turns 24swg enamelled copper wire on ferrite core

Mouser Electronics

Authorized Distributor

Click to View Pricing, Inventory, Delivery & Lifecycle Information:

[TT Electronics:](#)

[D2001UK](#)

Компания «Life Electronics» занимается поставками электронных компонентов импортного и отечественного производства от производителей и со складов крупных дистрибьюторов Европы, Америки и Азии.

С конца 2013 года компания активно расширяет линейку поставок компонентов по направлению коаксиальный кабель, кварцевые генераторы и конденсаторы (керамические, пленочные, электролитические), за счёт заключения дистрибьюторских договоров

Мы предлагаем:

- Конкурентоспособные цены и скидки постоянным клиентам.
- Специальные условия для постоянных клиентов.
- Подбор аналогов.
- Поставку компонентов в любых объемах, удовлетворяющих вашим потребностям.
- Приемлемые сроки поставки, возможна ускоренная поставка.
- Доставку товара в любую точку России и стран СНГ.
- Комплексную поставку.
- Работу по проектам и поставку образцов.
- Формирование склада под заказчика.
- Сертификаты соответствия на поставляемую продукцию (по желанию клиента).
- Тестирование поставляемой продукции.
- Поставку компонентов, требующих военную и космическую приемку.
- Входной контроль качества.
- Наличие сертификата ISO.

В составе нашей компании организован Конструкторский отдел, призванный помогать разработчикам, и инженерам.

Конструкторский отдел помогает осуществить:

- Регистрацию проекта у производителя компонентов.
- Техническую поддержку проекта.
- Защиту от снятия компонента с производства.
- Оценку стоимости проекта по компонентам.
- Изготовление тестовой платы монтаж и пусконаладочные работы.



Тел: +7 (812) 336 43 04 (многоканальный)

Email: org@lifeelectronics.ru