

## XW2R Series Connector-Terminal Block Conversion Units



» Simple connection to controllers

» **Slim design**

» Variety of models for various controller types

- Specialized wiring pattern for OMRON and Mitsubishi PLCs
- Minimized size with required number of poles
- Wide variation of poles

## General-purpose devices

### Wide variation of poles

#### M3 Screw

XW2R-J□□□□-T□



#### Clamp

XW2R-E□□□□-T□



#### Spring Clamp

XW2R-P□□□□-T□



To page 13 for details on models for general-purpose devices

To page 4 for details on models for OMRON PLCs

To page 9 for details on models for Mitsubishi PLCs

## All Models

- Spring Clamp terminals simplify wiring and make the terminal blocks even easier to use. (In comparison to the OMRON XW2F.)
- The terminal arrangement enables smoother wiring work.
- Mount to DIN Rail or with screws.
- Common design that can also be customized.

### Connecting Spring Clamp Terminals

#### Using Ferrules

- How to insert wire



Insert wire into the terminal block.

- How to release wire



Insert the screwdriver into the release hole and pull out the ferrule.

#### Using Stripped Wires



- Inserting and Removing Wires



To insert a wire, insert a screwdriver into the release hole and then insert the stripped wire. To remove a wire, insert a screwdriver into the release hole and then pull out the stripped wire.

# New Series XW2R

## Product Lineup

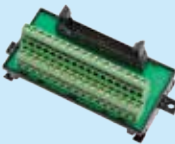
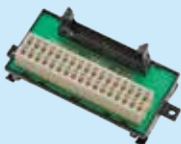
<b>Type</b>		 <b>PLCs</b> 		
<b>Features</b>		Specialized wiring pattern for PLC	Minimized size with required number of poles	
<b>Terminal Type</b>		M3 Screw	Clamp	Spring Clamp
<b>Model</b>	For OMRON PLC	XW2R-J34G-C□	XW2R-E34G-C□	XW2R-P34G-C□
	For Mitsubishi PLC	XW2R-J34G-M□	XW2R-E34G-M□	XW2R-P34G-M□
<b>Appearance</b>				

## Smart Features

### PLC Connecting type

- Wiring patterns that are specifically designed for PLCs reduce the work required to check signal layout.
- Terminal block signal labels give the PLC addresses.

General-purpose devices	<table border="1"> <tr><td>B1</td><td>B2</td><td>B3</td><td>B4</td><td>B5</td><td>B7</td><td>B8</td><td>B9</td><td>B10</td><td>B11</td><td>B12</td><td>B13</td><td>B14</td><td>B15</td></tr> <tr><td>A1</td><td>A2</td><td>A3</td><td>A4</td><td>A5</td><td>A6</td><td>A7</td><td>A8</td><td>A9</td><td>A10</td><td>A11</td><td>A12</td><td>A13</td><td>A14</td><td>A15</td></tr> </table>	B1	B2	B3	B4	B5	B7	B8	B9	B10	B11	B12	B13	B14	B15	A1	A2	A3	A4	A5	A6	A7	A8	A9	A10	A11	A12	A13	A14	A15																																			
B1	B2	B3	B4	B5	B7	B8	B9	B10	B11	B12	B13	B14	B15																																																				
A1	A2	A3	A4	A5	A6	A7	A8	A9	A10	A11	A12	A13	A14	A15																																																			
For PLCs from OMRON	<table border="1"> <tr><td>INC</td><td>0</td><td>1</td><td>2</td><td>3</td><td>4</td><td>5</td><td>6</td><td>7</td><td>8</td><td>9</td><td>10</td><td>11</td><td>12</td><td>13</td><td>14</td><td>15</td></tr> <tr><td>COM</td><td>0</td><td>1</td><td>2</td><td>3</td><td>4</td><td>5</td><td>6</td><td>7</td><td>8</td><td>9</td><td>10</td><td>11</td><td>12</td><td>13</td><td>14</td><td>15</td></tr> </table>	INC	0	1	2	3	4	5	6	7	8	9	10	11	12	13	14	15	COM	0	1	2	3	4	5	6	7	8	9	10	11	12	13	14	15																														
INC	0	1	2	3	4	5	6	7	8	9	10	11	12	13	14	15																																																	
COM	0	1	2	3	4	5	6	7	8	9	10	11	12	13	14	15																																																	
For PLCs from Mitsubishi	<table border="1"> <tr><td>1</td><td>0</td><td>1</td><td>1</td><td>2</td><td>1</td><td>3</td><td>1</td><td>4</td><td>1</td><td>5</td><td>1</td><td>6</td><td>1</td><td>7</td><td>1</td><td>8</td><td>1</td><td>9</td><td>1</td><td>A</td><td>1</td><td>B</td><td>1</td><td>C</td><td>1</td><td>D</td><td>1</td><td>E</td><td>1</td><td>F</td><td>COM</td></tr> <tr><td>0</td><td>0</td><td>1</td><td>0</td><td>2</td><td>0</td><td>3</td><td>0</td><td>4</td><td>0</td><td>5</td><td>0</td><td>6</td><td>0</td><td>7</td><td>0</td><td>8</td><td>0</td><td>9</td><td>0</td><td>A</td><td>0</td><td>B</td><td>0</td><td>C</td><td>0</td><td>D</td><td>0</td><td>E</td><td>0</td><td>F</td><td>NC</td></tr> </table>	1	0	1	1	2	1	3	1	4	1	5	1	6	1	7	1	8	1	9	1	A	1	B	1	C	1	D	1	E	1	F	COM	0	0	1	0	2	0	3	0	4	0	5	0	6	0	7	0	8	0	9	0	A	0	B	0	C	0	D	0	E	0	F	NC
1	0	1	1	2	1	3	1	4	1	5	1	6	1	7	1	8	1	9	1	A	1	B	1	C	1	D	1	E	1	F	COM																																		
0	0	1	0	2	0	3	0	4	0	5	0	6	0	7	0	8	0	9	0	A	0	B	0	C	0	D	0	E	0	F	NC																																		

### General-purpose devices

- More model variations are scheduled for future development, such as models with FCN, MR, or MDR connectors in addition to the current models with MIL connectors.

## Connection Examples

### ■ 32-point Input Unit or Output Unit

CJ1W-ID231 32-point



### ■ 64-point Input Unit or Output Unit

CJ1W-ID261 64-point



### ■ 64-point Output Unit

CJ1W-MD563 IN 32 Points, OUT 32 Points

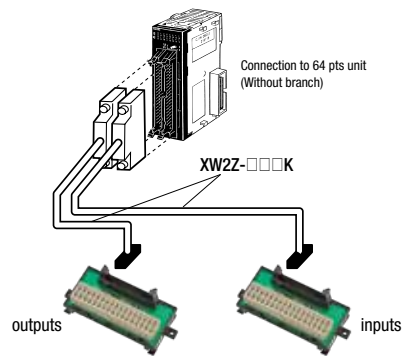

## Model List

XW2R - □ 34G - □ □

Wiring method	
J	M3 Screw
E	Clamp
P	Spring Clamp

Mounted Connector type	
G	MIL (XG4A)

PLC type	
C1	Refer to the following table for details.
C2	
C3	
C4	

## Models for OMRON PLCs

PLC Type	I/O	I/O Points	I/O Unit Model	Connecting cables
C1	Input	32	CJ1W-ID231	XW2Z-□□□B 32-point Unit: 1 Cable 64-point Unit: 2 Cables
			CS1W-ID231	
			C200H-ID216	
			C200H-ID218	
			CQM1-ID112	
			CQM1-ID213	
			CQM1-ID214	
			CJ1W-ID261	
	CS1W-ID261			
	C200H-ID217	64	C200H-ID219	
C200H-ID111				
C500-ID114	32	C500-ID219		
CJ1W-MD261 (inputs)				
I/O	32	CS1W-MD261 (inputs)		
		CS1W-MD262 (inputs)		
I/O	32	CS1W-MD561 (inputs)		
		CJ1W-ID232		
C2	Input	32	CJ1W-ID233	XW2Z-□□□K 32-point Unit: 1 Cable 64-point Unit: 2 Cables
		64	CJ1W-ID262	
I/O	32	CJ1W-MD263 (inputs)		
		CJ1W-MD563 (inputs)		
C3	Output	32	CJ1W-OD231	XW2Z-□□□B 32-point Unit: 1 Cable 64-point Unit: 2 Cables
			CS1W-OD231	
			CS1W-OD232	
			C200H-OD218	
			CQM1-OD213	
			CJ1W-OD261	
			CS1W-OD261	
			CS1W-OD262	
	C200H-OD219	64	C500-OD213	
	CJ1W-MD261 (outputs)			
	I/O	32	CS1W-MD261 (outputs)	
			CS1W-MD262 (outputs)	
	I/O	32	CS1W-MD561 (outputs)	
			CJ1W-OD232	
C4	Output	32	CJ1W-OD233	XW2Z-□□□K 32-point Unit: 1 Cable 64-point Unit: 2 Cables
		64	CJ1W-OD234	
I/O	32	CJ1W-OD262		
		CJ1W-OD263		
I/O	32	CJ1W-MD263 (outputs)		
		CJ1W-MD563 (outputs)		

\*Connection is not possible to all OMRON PLC Units.

\*□□□ is replaced by the cable length.

\*There is one common for each 32 points.

\*Refer to page 16-17 for information on Connecting Cables.

# Models for Connection to OMRON PLCs

## Clamp

Appearance	I/O Points (number of poles)	Model	Dimension A(mm)	Dimension B(mm)
	32 (34)	XW2R-E34G-C1	98.5	108
	32 (34)	XW2R-E34G-C2	98.5	108
	32 (34)	XW2R-E34G-C3	98.5	108
	32 (34)	XW2R-E34G-C4	98.5	108

## Ratings and Specifications

Rated current	0.5A/signal, 4A/common
Rated voltage	24VDC
Insulation resistance	100MΩ min.(at 500VDC)
Dielectric strength	500VAC for 1 min (leakage current: 1 mA max.)
Ambient operating temperature	0 to 55°C
Applicable wires	Applicable wire sizes AWG 22 to 16 (rod terminals) AWG 26 to 16 (twisted or solid wires)
	Stripped length 7 mm

## Details on Crimp Terminals

Applicable crimp terminals		Applicable wires
Rod	TC-05 Dia. = 1	AWG22 to AWG18 (0.30 to 0.75 mm <sup>2</sup> )
	TC-1.25S Dia. = 1.5	AWG22 to AWG16 (0.30 to 1.25 mm <sup>2</sup> )
Blade	BT1.25-9-1 BT1.25-10-1 W = 2.2	AWG22 to AWG16 (0.30 to 1.25 mm <sup>2</sup> )

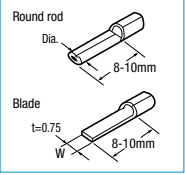

Note: Round rod and blade crimp terminals are made by Nichifu.

## Dimensions



(Unit:mm)

## Wiring Diagram

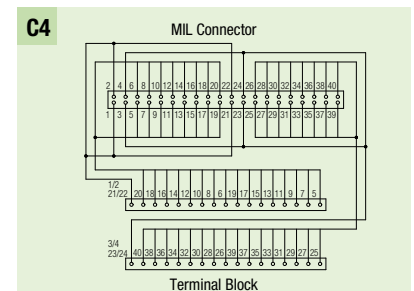
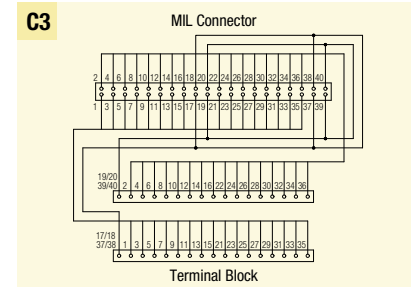
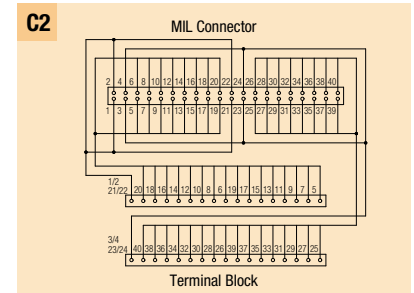
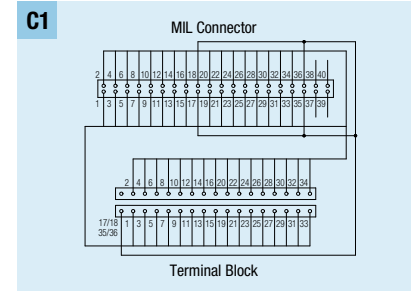

## Label Contents

### For C1 and C2

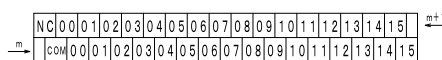

### For C3 and C4

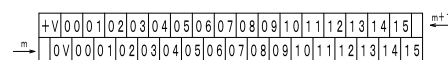

# Models for Connection to OMRON PLCs

## M3 Screw

Appearance	I/O Points (number of poles)	Model	Dimension A(mm)	Dimension B(mm)
	32 (34)	XW2R-J34G-C1	130.7	140.2
	32 (34)	XW2R-J34G-C2	130.7	140.2
	32 (34)	XW2R-J34G-C3	130.7	140.2
	32 (34)	XW2R-J34G-C4	130.7	140.2

### Ratings and Specifications

Rated current	0.5A/signal, 4A/common
Rated voltage	24VDC
Insulation resistance	100MΩ min.(at 500VDC)
Dielectric strength	500VAC for 1 min (leakage current: 1 mA max.)
Ambient operating temperature	0 to 55°C
Applicable wires	Applicable wire sizes
	Stripped length

AWG 22 to 16 (round or forked crimp terminals)  
AWG 26 to 16 (twisted or solid wires)  
9 mm

### Details on Crimp Terminals

- **Wiring Terminal Blocks**  
Use crimp terminals on terminal blocks with M3 screws.
- **Terminal Screw Tightening Torque**  
Use a tightening torque of 0.5 N·m when connecting wires or crimp terminals to the terminal block.

Applicable crimp terminals	Applicable wires
Round crimp terminals	1.25-3 AWG 22 to 16(0.30 to 1.25 mm <sup>2</sup> )
Forked crimp terminals	1.25Y-3 AWG 22 to 16(0.30 to 1.25 mm <sup>2</sup> )

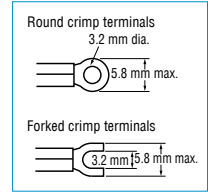

### Dimensions

(Unit:mm)

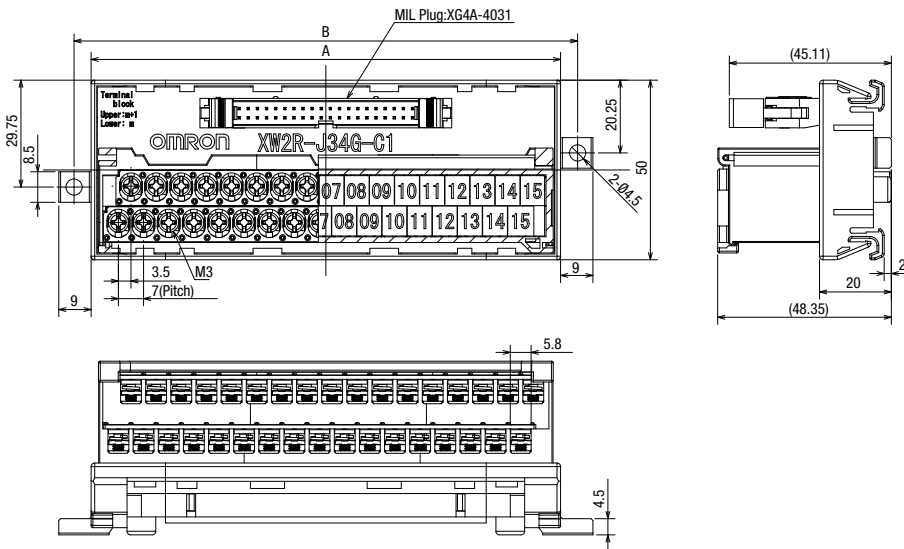

### Wiring Diagram



### Label Contents

#### For C1 and C2

NC	00	01	02	03	04	05	06	07	08	09	10	11	12	13	14	15
COM	00	01	02	03	04	05	06	07	08	09	10	11	12	13	14	15

#### For C3 and C4

+V	00	01	02	03	04	05	06	07	08	09	10	11	12	13	14	15
0V	00	01	02	03	04	05	06	07	08	09	10	11	12	13	14	15

# Models for Connection to Mitsubishi PLCs

## Model List



## Models for Connection to Mitsubishi PLCs

PLC Type	I/O Points	Mitsubishi PLC Module model	Connecting cables	
<b>M1</b>	32	LX41C4	XW2Z-□□□B: 1 cable	
		QX41		
		QX41-S1		
		QX41-S2		
		QX71		
		QH42P (input)		
		QX41Y41P (input)		
		A1SX41-S1		
		A1SX41-S2		
		A1SX71		
		A1SH42 (input)		
		A1SH42-S1 (input)		
		64		LX42C4
	QX42			
	QX42-S1			
	QX82			
	QX82-S1			
	A1SX42-S1			
	A1SX42-S2			
	A1SX82-S			
	<b>M2</b>		32	LY41NT1P
		QY41P		
QY71				
QH42P (output)				
QY41Y41P (output)				
A1SY41-S1				
A1SY41P				
A1SY42P				
A1SY71				
64		A1SH42 (output)	XW2Z-□□□B: 2 cables	
		A1SH42-S1 (output)		
		LY42NT1P		
		QY42P		
	A1SY42			

\*□□□ is replaced by the cable length.

\*Refer to page 16 for information on Connecting Cables.



# Models for Connection to OMRON PLCs

## Spring Clamp

Appearance	I/O Points (number of poles)	Model	Dimension A(mm)	Dimension B(mm)
	32 (34)	XW2R-P34G-C1	98.5	108
	32 (34)	XW2R-P34G-C2	98.5	108
	32 (34)	XW2R-P34G-C3	98.5	108
	32 (34)	XW2R-P34G-C4	98.5	108

## Ratings and Specifications

Rated current	0.5A/signal, 4A/common	
Rated voltage	24VDC	
Insulation resistance	100MΩ min. (at 500VDC)	
Dielectric strength	500VAC for 1 min	
Ambient operating temperature	0 to 55°C	
Applicable wires	Applicable wire sizes	AWG 24 to 14 (rod terminals), AWG 28 to 14 (twisted or solid wires) (Outer diameter of insulation must be 4 mm max)
	Stripped length	AWG28-16: 8 to 10 mm, AWG14: 9 to 10 mm

## Details on Crimp Terminals

### ● Applicable Ferrules

- Use ferrules of the lengths and thicknesses specified below. If other lengths or thicknesses are used, connection may not be possible or it may not be possible to insert or remove the posts.

### • Ferrule Dimensions

Square ferrules	Dimension A (Width)	2.7mm max.	The cross-sectional area after crimping must be 4.8 mm <sup>2</sup> or less
	Dimension B (Height)	2 mm max.	
Round ferrules	Dimension C (Diameter)	2 mm dia. max. (after crimping)	

### • Special Tools

Model XW4Z-00B



## Dimensions

(Unit:mm)



## Wiring Diagram

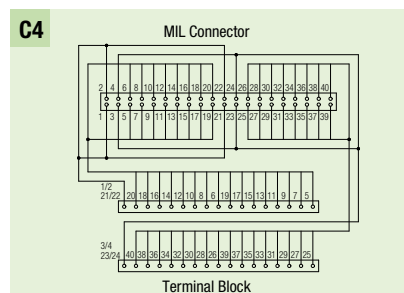
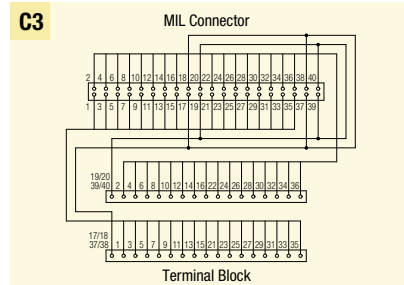
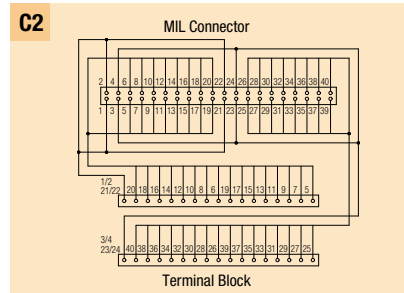
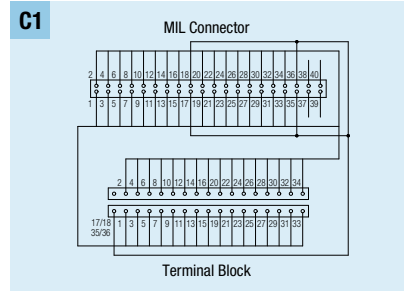

## Label Contents

### For C1 and C2

m	+	NC	0	0	1	2	3	4	5	6	7	8	9	10	11	12	13	14	15
m	-	COM	0	0	1	2	3	4	5	6	7	8	9	10	11	12	13	14	15

### For C3 and C4

m	+	+V	0	0	1	2	3	4	5	6	7	8	9	10	11	12	13	14	15
m	-	0V	0	0	1	2	3	4	5	6	7	8	9	10	11	12	13	14	15

# Models for Connection to Mitsubishi PLCs

## Clamp

Appearance	I/O Points (number of poles)	Model	Dimension A(mm)	Dimension B(mm)
	32 (34)	XW2R-E34G-M1	98.5	108
	32 (34)	XW2R-E34G-M2	98.5	108

## Ratings and Specifications

Rated current	0.5A/signal, 2A/common
Rated voltage	24VDC
Insulation resistance	100MΩ min. (at 500VDC)
Dielectric strength	500VAC for 1 min (leakage current: 1 mA max.)
Ambient operating temperature	0 to 55°C
Applicable wires	Applicable wire sizes
	AWG 22 to 16 (rod terminals) AWG 26 to 16 (twisted or solid wires)
Stripped length	7 mm

## Details on Crimp Terminals

Applicable crimp terminals		Applicable wires
Rod	TC-05 Dia. = 1	AWG22 to AWG18 (0.30 to 0.75 mm <sup>2</sup> )
	TC-1.25S Dia. = 1.5	AWG22 to AWG16 (0.30 to 1.25 mm <sup>2</sup> )
Blade	BT1.25-9-1 BT1.25-10-1	AWG22 to AWG16 (0.30 to 1.25 mm <sup>2</sup> )

Note: Round rod and blade crimp terminals are made by Nichifu.



## Dimensions



## Wiring Diagram



## Label Contents

### For M1

10	11	12	13	14	15	16	17	18	19	1A	1B	1C	1D	1E	1F	COM
00	01	02	03	04	05	06	07	08	09	0A	0B	0C	0D	0E	0F	NC

### For M2

10	11	12	13	14	15	16	17	18	19	1A	1B	1C	1D	1E	1F	V
00	01	02	03	04	05	06	07	08	09	0A	0B	0C	0D	0E	0F	OV

# Models for Connection to Mitsubishi PLCs

## M3 Screw

Appearance	I/O Points (number of poles)	Model	Dimension A(mm)	Dimension B(mm)
	32 (34)	XW2R-J34G-M1	130.7	140.2
	32 (34)	XW2R-J34G-M2	130.7	140.2

### Ratings and Specifications

Rated current	0.5A/signal, 2A/common	
Rated voltage	24VDC	
Insulation resistance	100MΩ min. (at 500VDC)	
Dielectric strength	500VAC for 1 min (leakage current: 1 mA max.)	
Ambient operating temperature	0 to 55°C	
Applicable wires	Applicable wire sizes	AWG 22 to 16 (round or forked crimp terminals) AWG 26 to 16 (twisted or solid wires)
	Stripped length	9 mm

### Details on Crimp Terminals

- **Wiring Terminal Blocks**  
Use crimp terminals on terminal blocks with M3 screws.
- **Terminal Screw Tightening Torque**  
Use a tightening torque of 0.5 N-m when connecting wires or crimp terminals to the terminal block.

Applicable crimp terminals	Applicable wires
Round crimp terminals	1.25-3 AWG 22 to 16(0.30 to 1.25 mm <sup>2</sup> )
Forked crimp terminals	1.25Y-3 AWG 22 to 16(0.30 to 1.25 mm <sup>2</sup> )



### Dimensions

(Unit:mm)



### Wiring Diagram



### Label Contents

For **M1**

1	0	1	1	2	3	4	5	6	7	8	9	A	B	C	D	E	F	COM															
0	0	0	1	0	2	0	3	0	4	0	5	0	6	0	7	0	8	0	9	0	A	0	B	0	C	0	D	0	E	0	F	0	NC

For **M2**

1	0	1	1	2	3	4	5	6	7	8	9	A	B	C	D	E	F	V															
0	0	0	1	0	2	0	3	0	4	0	5	0	6	0	7	0	8	0	9	0	A	0	B	0	C	0	D	0	E	0	F	0	V

## Model List

XW2R - □ □ □ □ □ - T

Wiring method	
<b>J</b>	M3 Screw
<b>E</b>	Clamp
<b>P</b>	Spring Clamp
<b>N</b>	e-CON*

Number of poles	
	<b>20</b>
	<b>34</b>
	<b>40</b>
	<b>50</b>
	<b>60</b>

Mounted Connector type	
<b>G</b>	MIL (XG4A)
<b>C</b>	MIL (XG4C)*
<b>F</b>	FCN*
<b>D</b>	D-sub*
<b>R</b>	MR*
<b>M</b>	MDR*

Plug/Socket	
<b>Blank</b>	Plug (male)
<b>R</b>	Socket (female)*

\* Scheduled for release soon.

## M3 Screw

Appearance	number of poles	Model	Dimension A(mm)	Dimension B(mm)
	20	XW2R-J20G-T	81.7	91.2
	34	XW2R-J34G-T	130.7	140.2
	40	XW2R-J40G-T	151.7	161.2
	50	XW2R-J50G-T	186.7	196.2
	60	XW2R-J60G-T	221.7	231.2

## Ratings and Specifications

Rated current	1A
Rated voltage	125VAC 24VDC
Insulation resistance	100MΩ min.(at 500VDC)
Dielectric strength	500VAC for 1 min (leakage current: 1 mA max.)
Ambient operating temperature	0 to 55°C

\*The details on crimp terminals are the same for the XW2R-J34G on page 6.

## Label Contents

B1	B2	B3	B4	B5	B6	B7	B8	B9	B10	B11	B12	B13	B14	B15	B16	B17
A1	A2	A3	A4	A5	A6	A7	A8	A9	A10	A11	A12	A13	A14	A15	A16	A17

\*The label contents for a Terminal Block with 34 poles are shown.

## Dimensions



## Wiring Diagram



# Models for Connection to Mitsubishi PLCs

## Spring Clamp

Appearance	I/O Points (number of poles)	Model	Dimension A(mm)	Dimension B(mm)
	32 (34)	XW2R-P34G-M1	98.5	108
	32 (34)	XW2R-P34G-M2	98.5	108

## Ratings and Specifications

Rated current	0.5A/signal, 2A/common
Rated voltage	24VDC
Insulation resistance	100MΩ min. (at 500VDC)
Dielectric strength	500VAC for 1 min
Ambient operating temperature	0 to 55°C
Applicable wires	Applicable wire sizes: AWG 24 to 14 (rod terminals), AWG 28 to 14 (twisted or solid wires) (Outer diameter of insulation must be 4 mm max) Stripped length: AWG28-16: 8 to 10 mm, AWG14: 9 to 10 mm

## Details on Crimp Terminals

### ● Applicable Ferrules

- Use ferrules of the lengths and thicknesses specified below. If other lengths or thicknesses are used, connection may not be possible or it may not be possible to insert or remove the posts.

### • Ferrule Dimensions

Square ferrules	Dimension A (Width)	2.7 mm max	The cross-sectional area after crimping must be 4.8 mm <sup>2</sup> or less
	Dimension B (Height)	2 mm max.	
Round ferrules	Dimension C (Diameter)	2 mm dia. max. (after crimping)	

### • Special Tools

Model	XW4Z-00B
-------	----------



## Dimensions

(Unit:mm)



## Wiring Diagram

### M1

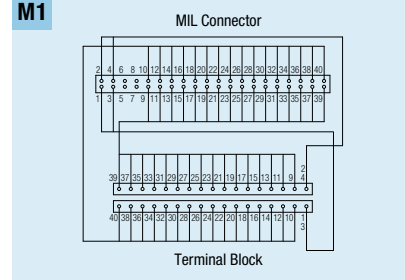

### M2



## Label Contents

### For M1

1	0	1	1	1	2	1	3	1	4	1	5	1	6	1	7	1	8	1	9	1	A	1	B	1	C	1	D	1	E	1	F	COM
0	0	0	1	0	2	0	3	0	4	0	5	0	6	0	7	0	8	0	9	0	A	0	B	0	C	0	D	0	E	0	F	NC

### For M2

1	0	1	1	1	2	1	3	1	4	1	5	1	6	1	7	1	8	1	9	1	A	1	B	1	C	1	D	1	E	1	F	+V
0	0	0	1	0	2	0	3	0	4	0	5	0	6	0	7	0	8	0	9	0	A	0	B	0	C	0	D	0	E	0	F	0V

## Spring Clamp

Appearance	number of poles	Model	Dimension A(mm)	Dimension B(mm)
	20	XW2R-P20G-T	64.4	73.9
	34	XW2R-P34G-T	98.5	108
	40	XW2R-P40G-T	113.5	123
	50	XW2R-P50G-T	138.5	148
	60	XW2R-P60G-T	163.5	173

### Ratings and Specifications

Rated current	1A
Rated voltage	125VAC 24VDC
Insulation resistance	100MΩ min.(at 500VDC)
Dielectric strength	500VAC for 1 min (leakage current: 1 mA max.)
Ambient operating temperature	0 to 55°C
Applicable wires	Applicable wire sizes
	Stripped length

AWG 24 to 14 (rod terminals), AWG 28 to 14 (twisted or solid wires)(Outer diameter of insulation must be 4 mm max)  
 AWG28-16: 8 to 10 mm, AWG14: 9 to 10 mm

\*The details on crimp terminals are the same for the XW2R-P34G on page 8.

### Label Contents

B	1	2	3	4	5	6	7	8	9	10	11	12	13	14	15	16	17
A	1	2	3	4	5	6	7	8	9	10	11	12	13	14	15	16	17

\*The label contents for a Terminal Block with 34 poles are shown.

### Dimensions

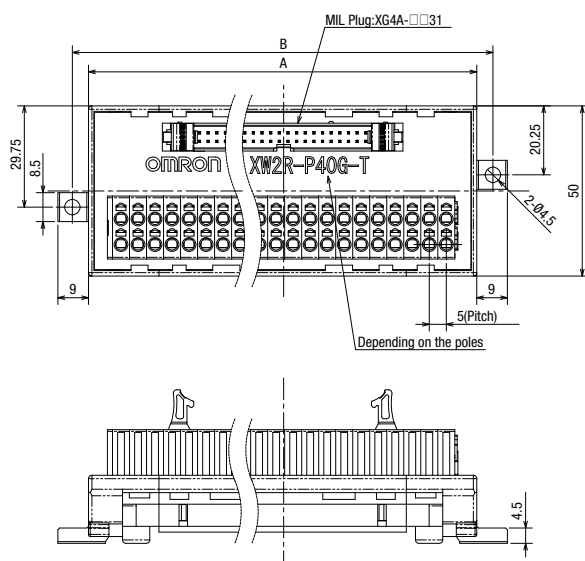

(Unit:mm)

### Wiring Diagram

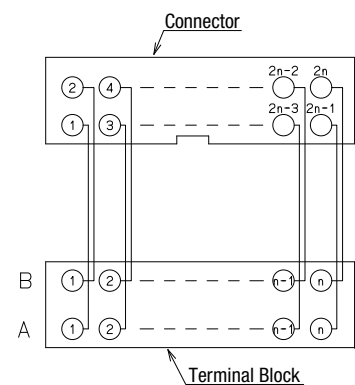

## Clamp

Appearance	number of poles	Model	Dimension A(mm)	Dimension B(mm)
	20	XW2R-E20G-T	64.4	73.9
	34	XW2R-E34G-T	98.5	108
	40	XW2R-E40G-T	113.5	123
	50	XW2R-E50G-T	138.5	148
	60	XW2R-E60G-T	163.5	173

### Ratings and Specifications

Rated current	1A
Rated voltage	125VAC 24VDC
Insulation resistance	100MΩ min.(at 500VDC)
Dielectric strength	500VAC for 1 min (leakage current: 1 mA max.)
Ambient operating temperature	0 to 55°C

\*The details on crimp terminals are the same for the XW2R-E34G on page 7.

### Label Contents

B	1	2	3	4	5	6	7	8	9	10	11	12	13	14	15	16	17
A	1	2	3	4	5	6	7	8	9	10	11	12	13	14	15	16	17

\*The label contents for a Terminal Block with 34 poles are shown.

### Dimensions



(Unit:mm)



### Wiring Diagram



# Connecting Cables

## XW2Z-□□□D

Connectors: One 40-pin Connector Made by Fujitsu Component, Ltd. to Two 20-pin MIL Connectors

Appearance	Model	Cable length L (m)	
		A	B
	XW2Z-100D	1	0.75
	XW2Z-150D	1.5	1.25
	XW2Z-200D	2	1.75
	XW2Z-300D	3	2.75
	XW2Z-500D	5	4.75
	XW2Z-010D	10	9.75
	XW2Z-15MD	15	14.75
	XW2Z-20MD	20	19.75



## Wiring Diagram



## XW2Z-□□□F

Connectors: One 20-pin MIL Connector to 20 Loose Wires with Crimp Terminals Attached

Appearance	Model	Cable length L (m)
	XW2Z-100F	1
	XW2Z-150F	1.5
	XW2Z-200F	2
	XW2Z-300F	3
	XW2Z-500F	5
	XW2Z-010F	10
	XW2Z-15MF	15
	XW2Z-20MF	20

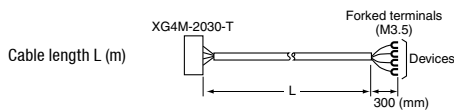

## Wiring Diagram

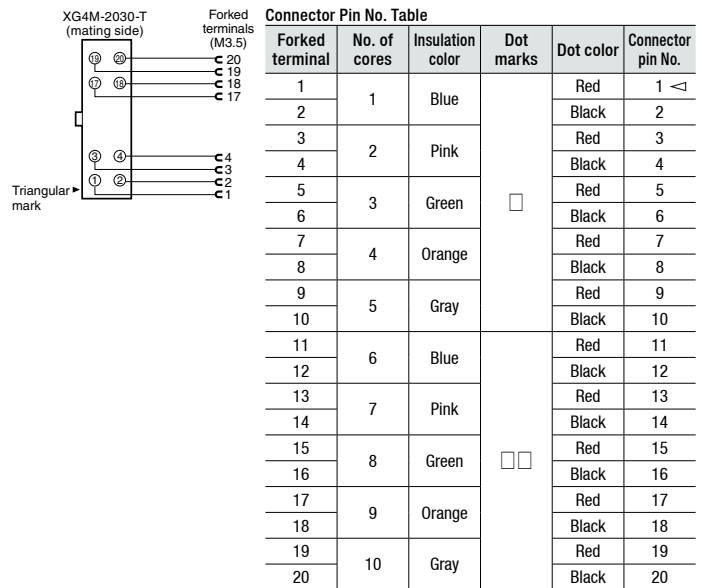

## XW2Z-□□□K

Connectors: One 40-pin MIL Connector to One 40-pin MIL Connector

Appearance	Model	Cable length L (m)
	XW2Z-C25K	0.25
	XW2Z-C50K	0.5
	XW2Z-100K	1
	XW2Z-150K	1.5
	XW2Z-200K	2
	XW2Z-300K	3
	XW2Z-500K	5
	XW2Z-010K	10



## Wiring Diagram

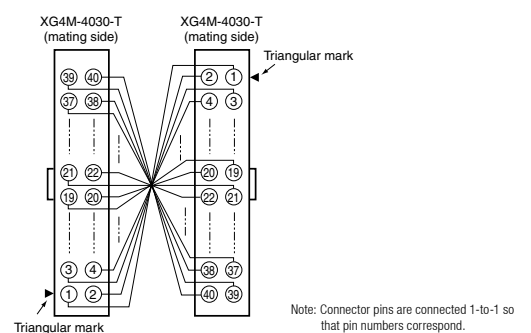



## XW2Z

### Appearance



### Ratings and Specifications

Rated current	1A
Rated voltage	125 VAC 24 VDC
Contact resistance	20 mΩ max. (at 20 mV, 100 mA max.) *1
Insulation resistance	100 MΩ min. (at 500 VDC)
Dielectric strength	500 VAC for 1 min (leakage current: 1 mA max.) *2
Ambient operating temperature	25 to 80°C

\*1. Contact resistance for the Connector. \*2. Dielectric strength for the Connector.

### Materials and Finish

Item	Part name	Materials and Finish	
Connectors	XG4M-2030 XG4M-4030	Housing	Fiber-glass reinforced PBT resin (UL94V-0)/black
		Cover	
	Contacts	Mating end	Phosphor bronze/nickel base, 0.15-μm gold plating
		Press-fit end	Phosphor bronze/nickel base, 2.0-μm tin plating
	XG4T-2004/4004	Strain Relief	Fiber-glass reinforced PBT resin (UL94V-0)/black
	FCN-367J024-AU/F * FCN-367J040-AU/F	Housing	Polyester resin (UL94V-0)/black
Contacts		Mating end	Copper alloy/gold plated
		Press-fit end	Copper alloy/tin plated
Connecting screw	Steel/nickel plated		
Cable	UL2464 Interface Cable	AWG28	
Crimp terminal	Forked crimp terminal	1.25 YAS 3.5 or the equivalent	

\* These housings, contacts, and connecting screws are made by Fujitsu Component, Ltd.

### XW2Z-□□□A

Connectors: One 24-pin Connector Made by Fujitsu Component, Ltd. to One 20-pin MIL Connector

Appearance	Model	Cable length L (m)
	XW2Z-050A	0.5
	XW2Z-100A	1
	XW2Z-150A	1.5
	XW2Z-200A	2
	XW2Z-300A	3
	XW2Z-500A	5
	XW2Z-700A	7
	XW2Z-010A	10
	XW2Z-15MA	15
	XW2Z-20MA	20

### Wiring Diagram

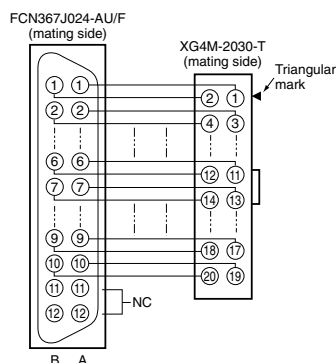

Cable length L (m)



### XW2Z-□□□B

Connectors: One 40-pin Connector Made by Fujitsu Component, Ltd. to One 40-pin MIL Connector

Appearance	Model	Cable length L (m)
	XW2Z-050B	0.5
	XW2Z-100B	1
	XW2Z-150B	1.5
	XW2Z-200B	2
	XW2Z-300B	3
	XW2Z-500B	5
	XW2Z-700B	7
	XW2Z-010B	10
	XW2Z-15MB	15
	XW2Z-20MB	20

### Wiring Diagram

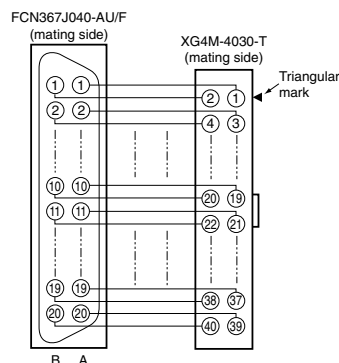

Cable length L (m)



# Safety Precautions

---

## Precautions for Correct Use

### ● Wiring Precautions

- Do not perform wiring work, remove connectors, or connect connectors while power is being supplied.  
Electric shock or damage to the device may result.
- Double-check all wiring before turning ON the power supply.
- After wiring, route the cable so that force is not applied directly to the connections.

### ● Wires for Terminal Blocks

- Do not damage the cores when stripping the insulation from them.
- Always twist stranded wires together before connecting them.
- Do not presolder wires. It may not be possible to connect them or remove them.

# Connecting Cables

## XW2Z-□□□L

Connectors: One 40-pin Connector Made by Fujitsu Component, Ltd. to Two 20-pin MIL Connectors

Appearance	Model	Cable length L (m)	
		A	B
	XW2Z-100L	1	0.75
	XW2Z-150L	1.5	1.25
	XW2Z-200L	2	1.75
	XW2Z-300L	3	2.75
	XW2Z-500L	5	4.75
	XW2Z-010L	10	9.75
	XW2Z-15ML	15	14.75
	XW2Z-20ML	20	19.75



### Wiring Diagram



## XW2Z-□□□N

Connectors: One 40-pin MIL Connector to Two 20-pin MIL Connectors

Appearance	Model	Cable length L (m)	
		A	B
	XW2Z-100N	1	0.75
	XW2Z-150N	1.5	1.25
	XW2Z-200N	2	1.75
	XW2Z-300N	3	2.75
	XW2Z-500N	5	4.75
	XW2Z-010N	10	9.75
	XW2Z-15MN	15	14.75
	XW2Z-20MN	20	19.75



### Wiring Diagram



## XW2Z-□□□X

Connectors: One 20-pin MIL Connector to One 20-pin MIL Connector

Appearance	Model	Cable length L (m)
	XW2Z-100X	1
	XW2Z-200X	2
	XW2Z-300X	3
	XW2Z-500X	5
	XW2Z-010X	10



### Wiring Diagram



OMRON AUTOMATION AND SAFETY • THE AMERICAS HEADQUARTERS • Schaumburg, IL USA • 847.843.7900 • 800.556.6766 • www.omron247.com

**OMRON CANADA, INC. • HEAD OFFICE**

Toronto, ON, Canada • 416.286.6465 • 866.986.6766 • www.omron247.com

**OMRON ELECTRONICS DE MEXICO • HEAD OFFICE**

México DF • 52.55.59.01.43.00 • 001.800.556.6766 • mela@omron.com

**OMRON ELECTRONICS DE MEXICO • SALES OFFICE**

Apodaca, N.L. • 52.81.11.56.99.20 • 001.800.556.6766 • mela@omron.com

**OMRON ELETRÔNICA DO BRASIL LTDA • HEAD OFFICE**

São Paulo, SP, Brasil • 55.11.2101.6300 • www.omron.com.br

**OMRON ARGENTINA • SALES OFFICE**

Cono Sur • 54.11.4783.5300

**OMRON CHILE • SALES OFFICE**

Santiago • 56.9.9917.3920

**OTHER OMRON LATIN AMERICA SALES**

54.11.4783.5300

OMRON EUROPE B.V. • Wegalaan 67-69, NL-2132 JD, Hoofddorp, The Netherlands. • Tel: +31 (0) 23 568 13 00 • Fax: +31 (0) 23 568 13 88 • www.industrial.omron.eu

*Authorized Distributor:*

**Automation Control Systems**

- Machine Automation Controllers (MAC) • Programmable Controllers (PLC)
- Operator interfaces (HMI) • Distributed I/O • Software

**Drives & Motion Controls**

- Servo & AC Drives • Motion Controllers & Encoders

**Temperature & Process Controllers**

- Single and Multi-loop Controllers

**Sensors & Vision**

- Proximity Sensors • Photoelectric Sensors • Fiber-Optic Sensors
- Amplified Photomicrosensors • Measurement Sensors
- Ultrasonic Sensors • Vision Sensors • RFID/Code Readers

**Industrial Components**

- Relays • Pushbuttons & Indicators • Limit and Basic Switches • Timers
- Counters • Metering Devices • Power Supplies

**Safety**

- Laser Scanners • Safety Mats • Edges and Bumpers
- Programmable Safety Controllers • Light Curtains • Safety Relays
- Safety Interlock Switches

# Mouser Electronics

Authorized Distributor

Click to View Pricing, Inventory, Delivery & Lifecycle Information:

## Omron:

[XW2R-E34G-C3](#) [XW2R-J34G-C4](#) [XW2R-E40G-T](#) [XW2R-E20G-T](#) [XW2R-J34G-C3](#) [XW2R-J40G-T](#) [XW2R-E34G-C4](#)  
[XW2R-J20G-T](#) [XW2R-P34G-C1](#) [XW2R-J34G-C2](#) [XW2R-P34G-C3](#) [XW2R-P34G-C4](#) [XW2R-E34G-C1](#) [XW2R-](#)  
[E34G-C2](#) [XW2R-J34G-C1](#) [XW2R-P20G-T](#) [XW2R-P34G-C2](#) [XW2R-P40G-T](#)

Компания «Life Electronics» занимается поставками электронных компонентов импортного и отечественного производства от производителей и со складов крупных дистрибьюторов Европы, Америки и Азии.

С конца 2013 года компания активно расширяет линейку поставок компонентов по направлению коаксиальный кабель, кварцевые генераторы и конденсаторы (керамические, пленочные, электролитические), за счёт заключения дистрибьюторских договоров

Мы предлагаем:

- Конкурентоспособные цены и скидки постоянным клиентам.
- Специальные условия для постоянных клиентов.
- Подбор аналогов.
- Поставку компонентов в любых объемах, удовлетворяющих вашим потребностям.
- Приемлемые сроки поставки, возможна ускоренная поставка.
- Доставку товара в любую точку России и стран СНГ.
- Комплексную поставку.
- Работу по проектам и поставку образцов.
- Формирование склада под заказчика.
- Сертификаты соответствия на поставляемую продукцию (по желанию клиента).
- Тестирование поставляемой продукции.
- Поставку компонентов, требующих военную и космическую приемку.
- Входной контроль качества.
- Наличие сертификата ISO.

В составе нашей компании организован Конструкторский отдел, призванный помогать разработчикам, и инженерам.

Конструкторский отдел помогает осуществить:

- Регистрацию проекта у производителя компонентов.
- Техническую поддержку проекта.
- Защиту от снятия компонента с производства.
- Оценку стоимости проекта по компонентам.
- Изготовление тестовой платы монтаж и пусконаладочные работы.



Тел: +7 (812) 336 43 04 (многоканальный)

Email: [org@lifeelectronics.ru](mailto:org@lifeelectronics.ru)