



Micro Commercial Components



Micro Commercial Components  
 20736 Marilla Street Chatsworth  
 CA 91311  
 Phone: (818) 701-4933  
 Fax: (818) 701-4939

# UMT1N

## Features

- Halogen free available upon request by adding suffix "-HF"
- Two 2SA1037AK chips in a package
- Mounting possible with SOT-363 automatic mounting machines.
- Transistor elements are independent, eliminating interference.
- Lead Free Finish/RoHS Compliant ("P" Suffix designates RoHS Compliant. See ordering information)
- Epoxy meets UL 94 V-0 flammability rating
- Moisture Sensitivity Level 1

## Dual Transistors

## Mechanical Data

- Case: SOT-363, Molded Plastic
- Polarity: See Diagram

### Maximum Ratings @ 25°C Unless Otherwise Specified

Symbol	Parameter	Value	Units
<b>OFF CHARACTERISTICS</b>			
$V_{(BR)CEO}$	Collector-Emitter Breakdown Voltage	-50	Vdc
$V_{(BR)CBO}$	Collector-Base Breakdown Voltage	-60	Vdc
$V_{(BR)EBO}$	Collector-Emitter Breakdown Voltage	-6.0	Vdc
$I_c$	Collector Current	-150	mAdc
$P_d$	Power Dissipation	150	mW
$T_J, T_{STG}$	Operating & Storage Temperature	-55~+150	°C

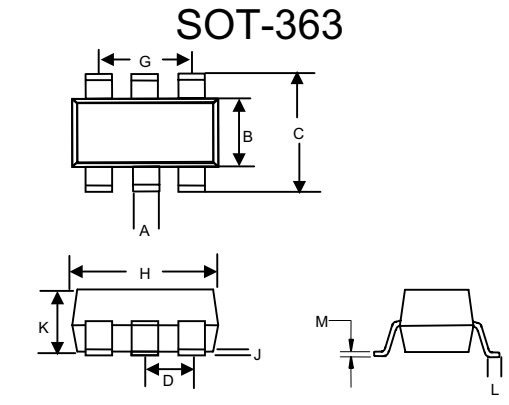

DIM	DIMENSIONS				NOTE
	INCHES		MM		
A	.006	.014	0.15	0.35	
B	.045	.053	1.15	1.35	
C	.085	.096	2.15	2.45	
D	.026		0.65Nominal		
G	.047	.055	1.20	1.40	
H	.071	.087	1.80	2.20	
J	---	.004	---	0.10	
K	.035	.043	0.90	1.10	
L	.010	.018	0.26	0.46	
M	.003	.006	0.08	0.15	

### MARKING:T1

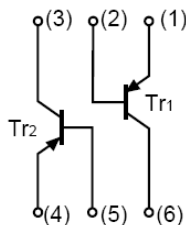

# UMT1N



Micro Commercial Components

## ELECTRICAL CHARACTERISTICS (Tamb=25°C unless otherwise specified)

Parameter	Symbol	Test conditions	MIN	TYP	MAX	UNIT
Collector-base breakdown voltage	$V_{(BR)CBO}$	$I_C = -50\mu A, I_E = 0$	-60			V
Collector-emitter breakdown Voltage	$V_{(BR)CEO}$	$I_C = -1mA, I_B = 0$	-50			V
Emitter-base breakdown voltage	$V_{(BR)EBO}$	$I_E = -50\mu A, I_C = 0$	-6			V
Collector cut-off current	$I_{CBO}$	$V_{CB} = -60V, I_E = 0$			-0.1	$\mu A$
Emitter cut-off current	$I_{EBO}$	$V_{EB} = -6V, I_C = 0$			-0.1	$\mu A$
DC current gain	$h_{FE}$	$V_{CE} = -6V, I_C = -1mA$	120		560	
Collector-emitter saturation voltage	$V_{CE(sat)}$	$I_C = -50mA, I_B = -5mA$			-0.5	V
Transition frequency	$f_T$	$V_{CE} = -12V, I_E = 2mA,$ $f = 100MHz$		140		MHz
Output capacitance	$C_{ob}$	$V_{CB} = -12V, I_E = 0, f = 1MHz$			5	pF

# UMT1N



Micro Commercial Components

## Typical Characteristics

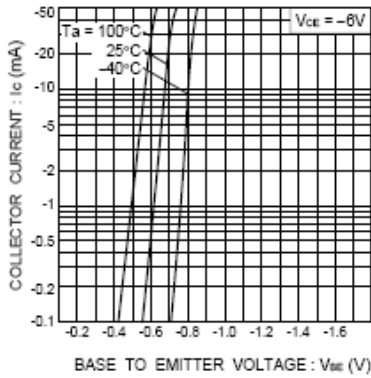

Fig.1 Grounded emitter propagation characteristics

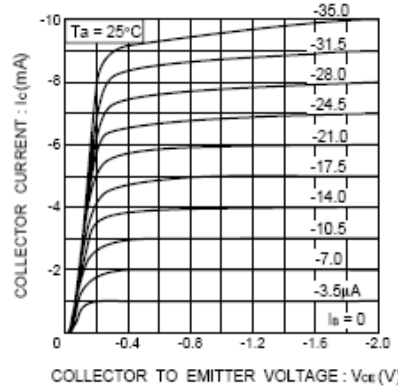

Fig.2 Grounded emitter output characteristics ( I )

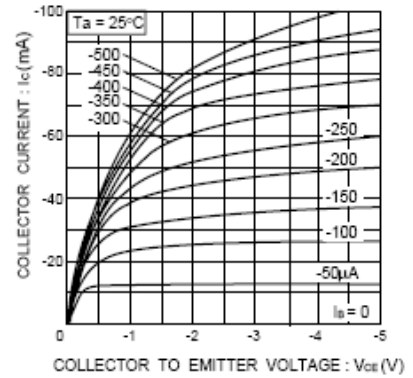

Fig.3 Grounded emitter output characteristics ( II )

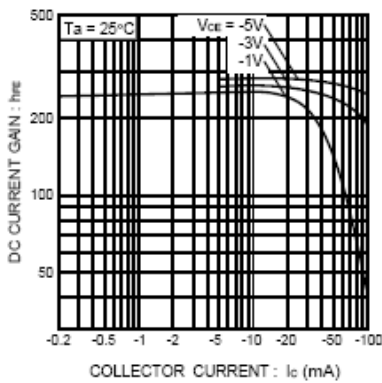

Fig.4 DC current gain vs. collector current ( I )

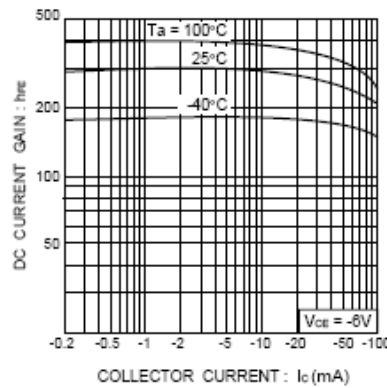

Fig.5 DC current gain vs. collector current ( II )

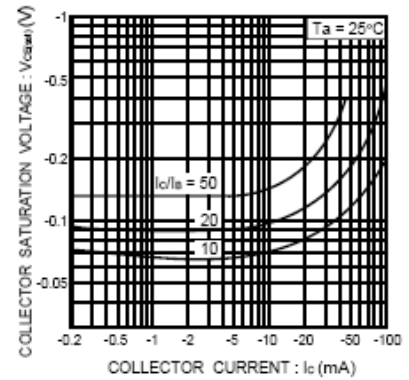

Fig.6 Collector-emitter saturation voltage vs. collector current ( I )

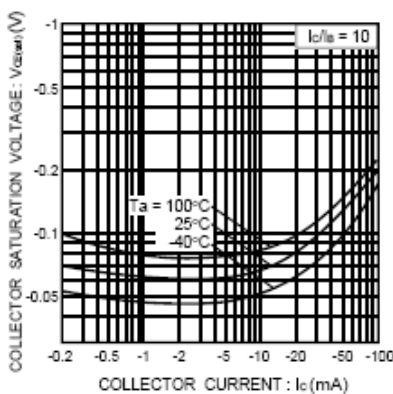

Fig.7 Collector-emitter saturation voltage vs. collector current ( II )

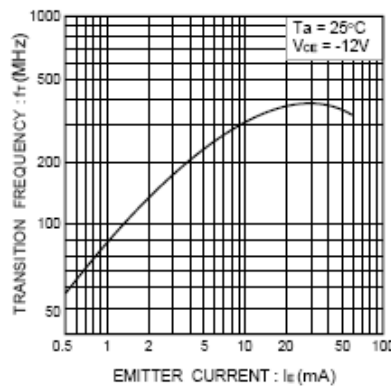

Fig.8 Gain bandwidth product vs. emitter current

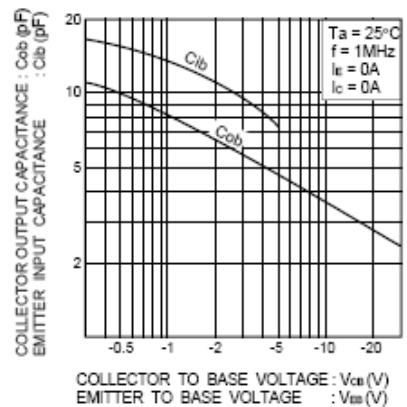

Fig.9 Collector output capacitance vs. collector-base voltage  
Emitter input capacitance vs. emitter-base voltage



Micro Commercial Components

### Ordering Information :

Device	Packing
Part Number-TP	Tape&Reel; 3Kpcs/Reel

Note : Adding "-HF" suffix for halogen free, eg. Part Number-TP-HF

#### \*\*\*IMPORTANT NOTICE\*\*\*

**Micro Commercial Components Corp.** reserves the right to make changes without further notice to any product herein to make corrections, modifications, enhancements, improvements, or other changes. **Micro Commercial Components Corp.** does not assume any liability arising out of the application or use of any product described herein; neither does it convey any license under its patent rights, nor the rights of others. The user of products in such applications shall assume all risks of such use and will agree to hold **Micro Commercial Components Corp.** and all the companies whose products are represented on our website, harmless against all damages.

#### \*\*\*LIFE SUPPORT\*\*\*

MCC's products are not authorized for use as critical components in life support devices or systems without the express written approval of Micro Commercial Components Corporation.

#### \*\*\*CUSTOMER AWARENESS\*\*\*

Counterfeiting of semiconductor parts is a growing problem in the industry. Micro Commercial Components (MCC) is taking strong measures to protect ourselves and our customers from the proliferation of counterfeit parts. MCC strongly encourages customers to purchase MCC parts either directly from MCC or from Authorized MCC Distributors who are listed by country on our web page cited below. Products customers buy either from MCC directly or from Authorized MCC Distributors are genuine parts, have full traceability, meet MCC's quality standards for handling and storage. **MCC will not provide any warranty coverage or other assistance for parts bought from Unauthorized Sources.** MCC is committed to combat this global problem and encourage our customers to do their part in stopping this practice by buying direct or from authorized distributors.

[www.mccsemi.com](http://www.mccsemi.com)

Компания «Life Electronics» занимается поставками электронных компонентов импортного и отечественного производства от производителей и со складов крупных дистрибьюторов Европы, Америки и Азии.

С конца 2013 года компания активно расширяет линейку поставок компонентов по направлению коаксиальный кабель, кварцевые генераторы и конденсаторы (керамические, пленочные, электролитические), за счёт заключения дистрибьюторских договоров

Мы предлагаем:

- Конкурентоспособные цены и скидки постоянным клиентам.
- Специальные условия для постоянных клиентов.
- Подбор аналогов.
- Поставку компонентов в любых объемах, удовлетворяющих вашим потребностям.
- Приемлемые сроки поставки, возможна ускоренная поставка.
- Доставку товара в любую точку России и стран СНГ.
- Комплексную поставку.
- Работу по проектам и поставку образцов.
- Формирование склада под заказчика.
- Сертификаты соответствия на поставляемую продукцию (по желанию клиента).
- Тестирование поставляемой продукции.
- Поставку компонентов, требующих военную и космическую приемку.
- Входной контроль качества.
- Наличие сертификата ISO.

В составе нашей компании организован Конструкторский отдел, призванный помогать разработчикам, и инженерам.

Конструкторский отдел помогает осуществить:

- Регистрацию проекта у производителя компонентов.
- Техническую поддержку проекта.
- Защиту от снятия компонента с производства.
- Оценку стоимости проекта по компонентам.
- Изготовление тестовой платы монтаж и пусконаладочные работы.



Тел: +7 (812) 336 43 04 (многоканальный)

Email: [org@lifeelectronics.ru](mailto:org@lifeelectronics.ru)

[www.lifeelectronics.ru](http://www.lifeelectronics.ru)