

RoHS Qxx10xx & Qxx10xHx Series



Description

10 Amp bi-directional solid state switch series is designed for AC switching and phase control applications such as motor speed and temperature modulation controls, lighting controls, and static switching relays.

Standard type devices normally operate in Quadrants I & III triggered from AC line.

Features & Benefits

- RoHS Compliant
- Glass – passivated junctions
- Voltage capability up to 1000 V
- Surge capability up to 120 A
- Electrically isolated package "L - Package" and UL recognized for 2500Vrms
- Solid-state switching eliminates arcing or contact bounce that create voltage transients
- No contacts to wear out from reaction of switching events
- Restricted (or limited) RFI generation, depending on activation point sine wave

Agency Approval

| Agency | Agency File Number |
|--------|--------------------|
| | L Package: E71639 |

Main Features

| Symbol | Value | Unit |
|-------------------|-------------|------|
| $I_{T(RMS)}$ | 10 | A |
| V_{DRM}/V_{RRM} | 400 to 1000 | V |
| $I_{GT(Q1)}$ | 25 to 50 | mA |

Schematic Symbol

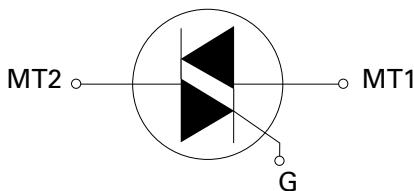

Applications

Alternistor type devices are used in applications requiring high commutation performance such as controlling inductive loads. Isolated packages are offered with internal construction, having the case or mounting tab electrically isolated from the semiconductor chip.

Absolute Maximum Ratings — Standard Triac

| Symbol | Parameter | Value | Unit | | |
|--------------|--|--|---------------------------|------------|------------------------|
| $I_{T(RMS)}$ | RMS on-state current (full sine wave) | Qxx10Ry/ Qxx10Ny | $T_C = 95^\circ\text{C}$ | 10 | A |
| | | Qxx10Ly | $T_C = 90^\circ\text{C}$ | | |
| I_{TSM} | Non repetitive surge peak on-state current (full cycle, T_J initial = 25°C) | f = 50 Hz | t = 20 ms | 100 | A |
| | | f = 60 Hz | t = 16.7 ms | 120 | |
| I^2t | I^2t Value for fusing | $t_p = 8.3$ ms | | 60 | A^2s |
| di/dt | Critical rate of rise of on-state current $I_G = 200\text{mA}$ with $\leq 0.1\mu\text{s}$ rise time | f = 120 Hz | $T_J = 125^\circ\text{C}$ | 70 | $\text{A}/\mu\text{s}$ |
| I_{GTM} | Peak gate trigger current | $t_p \leq 10 \mu\text{s}$ $I_{GT} \leq I_{GTM}$ | $T_J = 125^\circ\text{C}$ | 1.8 | A |
| $P_{G(AV)}$ | Average gate power dissipation | | $T_J = 125^\circ\text{C}$ | 0.5 | W |
| T_{stg} | Storage temperature range | | | -40 to 150 | $^\circ\text{C}$ |
| T_J | Operating junction temperature range | | | -40 to 125 | $^\circ\text{C}$ |

Absolute Maximum Ratings — Alternistor Triac (3 Quadrants)

| Symbol | Parameter | Value | Unit | | |
|--------------|---|--|---------------------------|------------|------------------------|
| $I_{T(RMS)}$ | RMS on-state current (full sine wave) | Qxx10LHy | $T_C = 90^\circ\text{C}$ | 10 | A |
| | | Qxx10RHy/ Qxx10NHy | $T_C = 95^\circ\text{C}$ | | |
| I_{TSM} | Non repetitive surge peak on-state current (full cycle, T_J initial = 25°C) | f = 50 Hz | t = 20 ms | 110 | A |
| | | f = 60 Hz | t = 16.7 ms | 120 | |
| I^2t | I^2t Value for fusing | $t_p = 8.3$ ms | | 60 | A^2s |
| di/dt | Critical rate of rise of on-state current | f = 120 Hz | $T_J = 125^\circ\text{C}$ | 70 | $\text{A}/\mu\text{s}$ |
| I_{GTM} | Peak gate trigger current | $t_p \leq 10 \mu\text{s}$ $I_{GT} \leq I_{GTM}$ | $T_J = 125^\circ\text{C}$ | 2.0 | A |
| $P_{G(AV)}$ | Average gate power dissipation | | $T_J = 125^\circ\text{C}$ | 0.5 | W |
| T_{stg} | Storage temperature range | | | -40 to 150 | $^\circ\text{C}$ |
| T_J | Operating junction temperature range | | | -40 to 125 | $^\circ\text{C}$ |

Electrical Characteristics ($T_J = 25^\circ\text{C}$, unless otherwise specified) — Standard Triac

| Symbol | Test Conditions | Quadrant | Qxx10x4 | Qxx10x5 | Unit |
|----------|---|--------------------|----------|----------------|------------------|
| I_{GT} | $V_D = 12\text{V}$ $R_L = 60 \Omega$ | I – II – III IV | 25 50 | 50 75 (TYP) | mA |
| V_{GT} | | I – II – III | 1.3 | | V |
| V_{GD} | $V_D = V_{DRM}$ $R_L = 3.3 \text{k}\Omega$ $T_J = 125^\circ\text{C}$ | ALL | 0.2 | | V |
| I_H | $I_T = 200\text{mA}$ | MAX. | 35 | 50 | mA |
| dv/dt | $V_D = V_{DRM}$ Gate Open $T_J = 125^\circ\text{C}$ | 400V | 150 | 225 | V/ μs |
| | | 600V | 100 | 200 | |
| | | 800V | 75 | 175 | |
| | $V_D = V_{DRM}$ Gate Open $T_J = 100^\circ\text{C}$ | 1000V | 50 | 150 | |
| (dv/dt)c | (di/dt)c = 5.4 A/ms $T_J = 125^\circ\text{C}$ | TYP. | 2 | 4 | V/ μs |
| t_{gt} | $I_G = 2 \times I_{GT}$ PW = 15 μs $I_T = 14.1 \text{A(pk)}$ | TYP. | 3.0 | 3.0 | μs |

Note: xx = voltage, x = package, y = sensitivity

Electrical Characteristics ($T_J = 25^\circ\text{C}$, unless otherwise specified) — Alternistor Triac (3 Quadrants)

| Symbol | Test Conditions | Quadrant | | Value | Unit |
|--------------|---|--------------|------|-------|------------------|
| I_{GT} | $V_D = 12\text{V}$ $R_L = 60\ \Omega$ | I – II – III | MAX. | 50 | mA |
| V_{GT} | | I – II – III | MAX. | 1.3 | V |
| V_{GD} | $V_D = V_{DRM}$ $R_L = 3.3\ \text{k}\Omega$ $T_J = 125^\circ\text{C}$ | I – II – III | MIN. | 0.2 | V |
| I_H | $I_T = 100\text{mA}$ | | MAX. | 50 | mA |
| dv/dt | $V_D = V_{DRM}$ Gate Open $T_J = 125^\circ\text{C}$ | 400V | MIN. | 750 | V/ μs |
| | | 600V | | 650 | |
| | | 800V | | 500 | |
| | $V_D = V_{DRM}$ Gate Open $T_J = 100^\circ\text{C}$ | 1000V | | 300 | |
| (dv/dt)c | (di/dt)c = 5.4 A/ms $T_J = 125^\circ\text{C}$ | | TYP. | 30 | V/ μs |
| t_{gt} | $I_G = 2 \times I_{GT}$ $PW = 15\ \mu\text{s}$ $I_T = 14.1\ \text{A(pk)}$ | | TYP. | 4.0 | μs |

Static Characteristics

| Symbol | Test Conditions | | Value | Unit | |
|------------------------|--|---------------------------|------------|------|---------------|
| V_{TM} | $I_{TM} = 14.1\text{A}$ $t_p = 380\ \mu\text{s}$ | | MAX. | 1.60 | V |
| I_{DRM} I_{RRM} | $V_{DRM} = V_{RRM}$ | $T_J = 25^\circ\text{C}$ | 400 - 600V | 10 | μA |
| | | $T_J = 125^\circ\text{C}$ | 400 - 800V | 2 | mA |
| | | $T_J = 100^\circ\text{C}$ | 1000V | 3 | |

Thermal Resistances

| Symbol | Parameter | | Value | Unit |
|-------------------|--------------------------|-----------------------|-------|--------------------|
| $R_{\theta(J-C)}$ | Junction to case (AC) | Qxx10Ryy/ Qxx10Nyy | 1.3 | $^\circ\text{C/W}$ |
| | | Qxx10Lyy | 2.6 | |
| $R_{\theta(J-A)}$ | Junction to ambient (AC) | Qxx10Ryy | 45 | $^\circ\text{C/W}$ |
| | | Qxx10Lyy | 50 | |

Note: xx = voltage, x = package, y = sensitivity, yy = type & sensitivity

Figure 1: Definition of Quadrants

Figure 2: Normalized DC Gate Trigger Current for All Quadrants vs. Junction Temperature

Figure 3: Normalized DC Holding Current vs. Junction Temperature

Figure 4: Normalized DC Gate Trigger Voltage for All Quadrants vs. Junction Temperature

Figure 5: Power Dissipation (Typical) vs. RMS On-State Current

Figure 6: Maximum Allowable Case Temperature vs. On-State Current

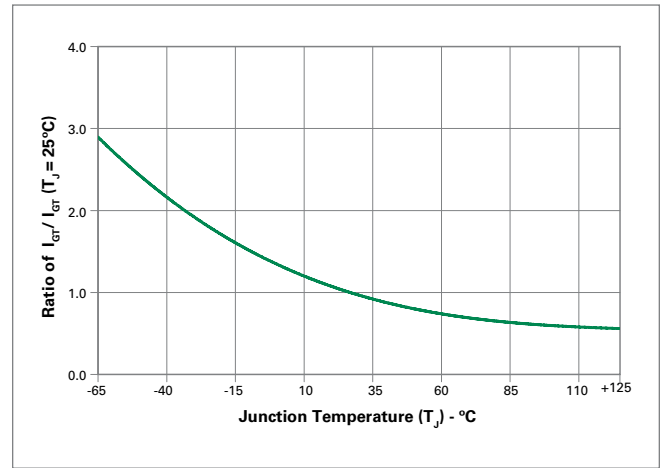
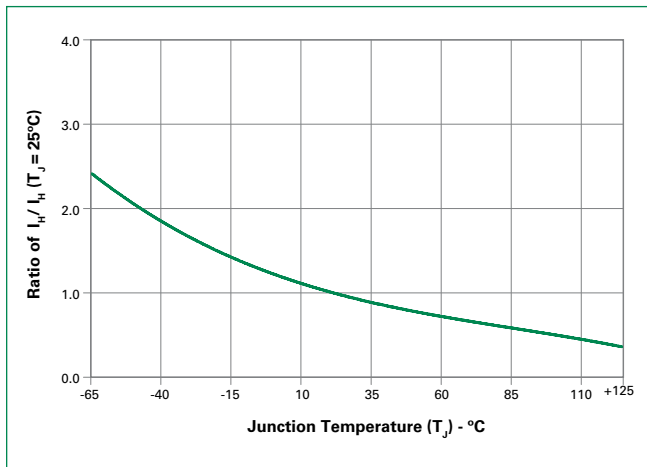
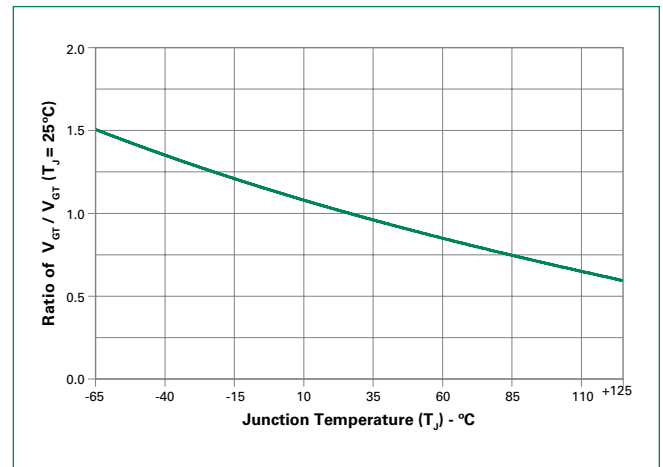
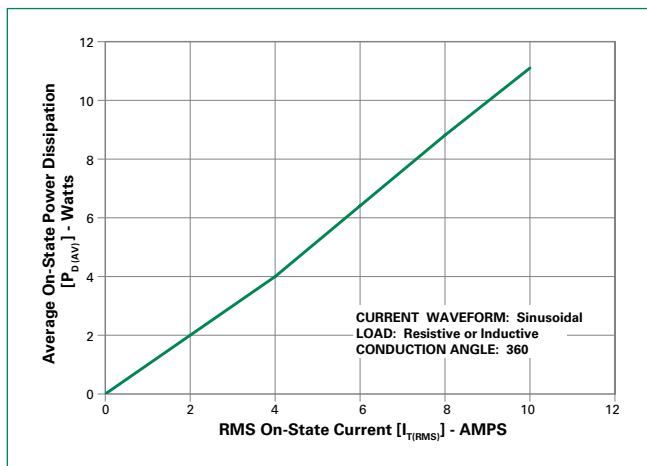
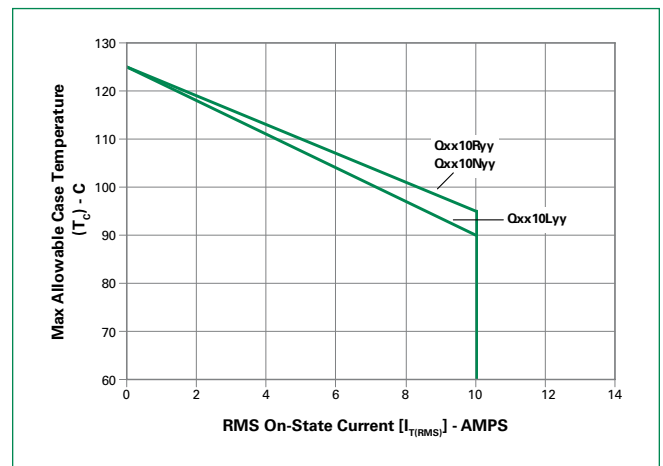
Figure 7: Maximum Allowable Ambient Temperature vs. On-State Current

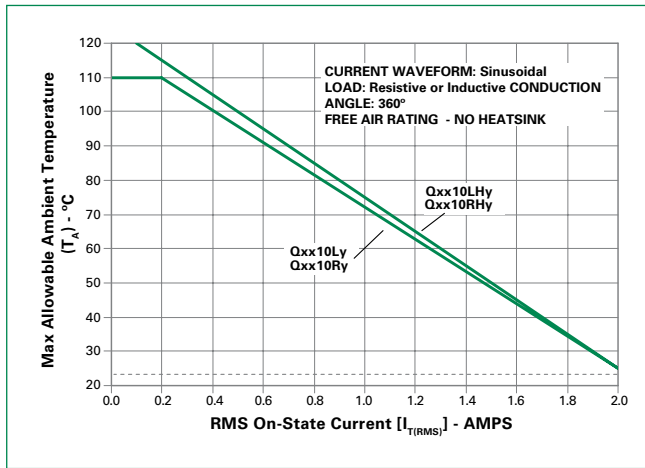

Figure 8: On-State Current vs. On-State Voltage (Typical)

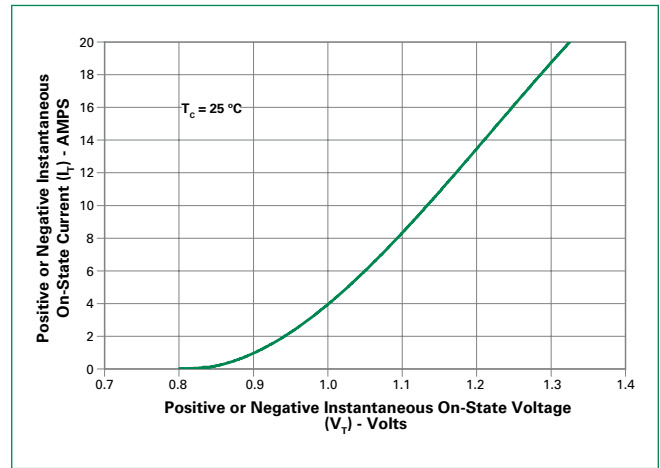
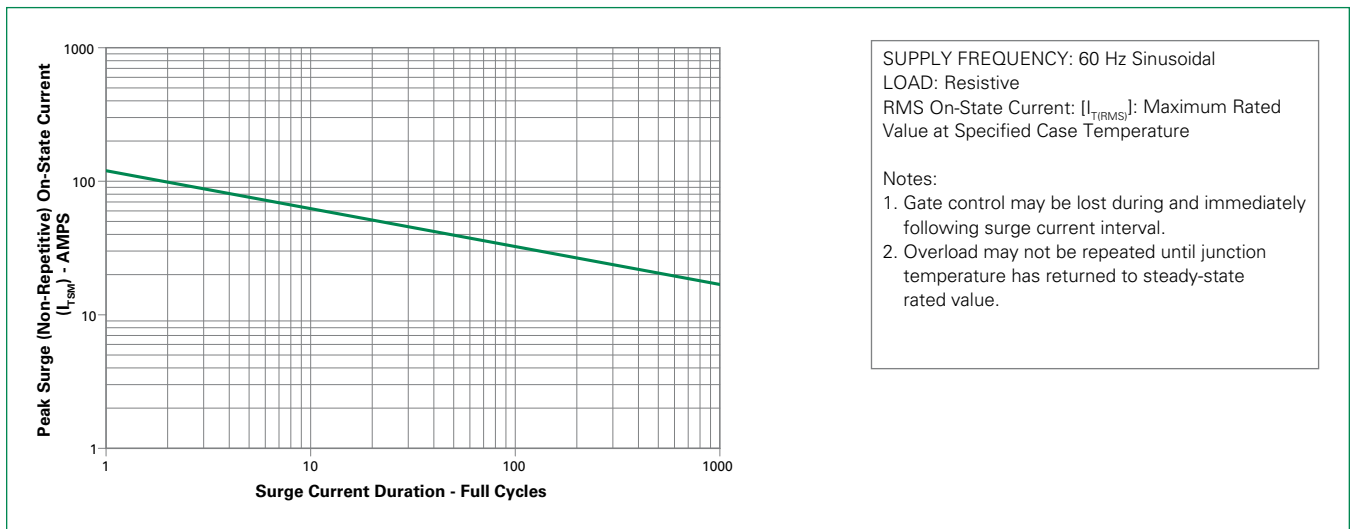
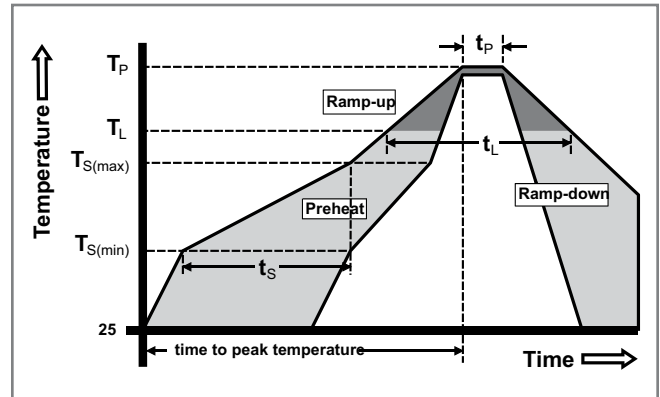

Figure 9: Surge Peak On-State Current vs. Number of Cycles



Soldering Parameters

| | | |
|--|------------------------------------|-------------------------|
| Reflow Condition | | Pb – Free assembly |
| Pre Heat | - Temperature Min ($T_{s(min)}$) | 150°C |
| | - Temperature Max ($T_{s(max)}$) | 200°C |
| | - Time (min to max) (t_s) | 60 – 180 secs |
| Average ramp up rate (Liquidus Temp (T_L) to peak) | | 5°C/second max |
| $T_{s(max)}$ to T_L - Ramp-up Rate | | 5°C/second max |
| Reflow | - Temperature (T_L) (Liquidus) | 217°C |
| | - Temperature (t_L) | 60 – 150 seconds |
| Peak Temperature (T_p) | | 260 ^{+0/-5} °C |
| Time within 5°C of actual peak Temperature (t_p) | | 20 – 40 seconds |
| Ramp-down Rate | | 5°C/second max |
| Time 25°C to peak Temperature (T_p) | | 8 minutes Max. |
| Do not exceed | | 280°C |



Physical Specifications

| | |
|--------------------------|--|
| Terminal Finish | 100% Matte Tin-plated |
| Body Material | UL recognized epoxy meeting flammability classification 94V-0. |
| Terminal Material | Copper Alloy |

Design Considerations

Careful selection of the correct device for the application's operating parameters and environment will go a long way toward extending the operating life of the Thyristor. Good design practice should limit the maximum continuous current through the main terminals to 75% of the device rating. Other ways to ensure long life for a power discrete semiconductor are proper heat sinking and selection of voltage ratings for worst case conditions. Overheating, overvoltage (including dv/dt), and surge currents are the main killers of semiconductors. Correct mounting, soldering, and forming of the leads also help protect against component damage.

Environmental Specifications

| Test | Specifications and Conditions |
|----------------------------------|---|
| AC Blocking | MIL-STD-750, M-1040, Cond A Applied Peak AC voltage @ 125°C for 1008 hours |
| Temperature Cycling | MIL-STD-750, M-1051, 100 cycles; -40°C to +150°C, 15-min dwell-time |
| Temperature/Humidity | EIA/JEDEC, JESD22-A101 1008 hours; 320V - DC: 85°C; 85% rel humidity |
| High Temp Storage | MIL-STD-750, M-1031, 1008 hours; 150°C |
| Low-Temp Storage | 1008 hours; -40°C |
| Thermal Shock | MIL-STD-750, M-1056 10 cycles; 0°C to 100°C; 5-min dwell time at each temperature; 10 sec (max) transfer time between temperature |
| Autoclave | EIA/JEDEC, JESD22-A102 168 hours (121°C at 2 ATMs) and 100% R/H |
| Resistance to Solder Heat | MIL-STD-750 Method 2031 |
| Solderability | ANSI/J-STD-002, category 3 Test A |
| Lead Bend | MIL-STD-750, M-2036 Cond E |

Dimensions — TO-220AB (R-Package) — Non-Isolated Mounting Tab Common with Center Lead



Note: Maximum torque to be applied to mounting tab is 8 in-lbs. (0.904 Nm).

| Dimension | Inches | | Millimeters | |
|-----------|--------|-------|-------------|-------|
| | Min | Max | Min | Max |
| A | 0.380 | 0.420 | 9.65 | 10.67 |
| B | 0.105 | 0.115 | 2.67 | 2.92 |
| C | 0.230 | 0.250 | 5.84 | 6.35 |
| D | 0.590 | 0.620 | 14.99 | 15.75 |
| E | 0.142 | 0.147 | 3.61 | 3.73 |
| F | 0.110 | 0.130 | 2.79 | 3.30 |
| G | 0.540 | 0.575 | 13.72 | 14.61 |
| H | 0.025 | 0.035 | 0.64 | 0.89 |
| J | 0.195 | 0.205 | 4.95 | 5.21 |
| K | 0.095 | 0.105 | 2.41 | 2.67 |
| L | 0.060 | 0.075 | 1.52 | 1.91 |
| M | 0.085 | 0.095 | 2.16 | 2.41 |
| N | 0.018 | 0.024 | 0.46 | 0.61 |
| O | 0.178 | 0.188 | 4.52 | 4.78 |
| P | 0.045 | 0.060 | 1.14 | 1.52 |
| R | 0.038 | 0.048 | 0.965 | 1.22 |

Dimensions — TO-220AB (L-Package) — Isolated Mounting Tab



Note: Maximum torque to be applied to mounting tab is 8 in-lbs. (0.904 Nm).

| Dimension | Inches | | Millimeters | |
|-----------|--------|-------|-------------|-------|
| | Min | Max | Min | Max |
| A | 0.380 | 0.420 | 9.65 | 10.67 |
| B | 0.105 | 0.115 | 2.67 | 2.92 |
| C | 0.230 | 0.250 | 5.84 | 6.35 |
| D | 0.590 | 0.620 | 14.99 | 15.75 |
| E | 0.142 | 0.147 | 3.61 | 3.73 |
| F | 0.110 | 0.130 | 2.79 | 3.30 |
| G | 0.540 | 0.575 | 13.72 | 14.61 |
| H | 0.025 | 0.035 | 0.64 | 0.89 |
| J | 0.195 | 0.205 | 4.95 | 5.21 |
| K | 0.095 | 0.105 | 2.41 | 2.67 |
| L | 0.060 | 0.075 | 1.52 | 1.91 |
| M | 0.085 | 0.095 | 2.16 | 2.41 |
| N | 0.018 | 0.024 | 0.46 | 0.61 |
| O | 0.178 | 0.188 | 4.52 | 4.78 |
| P | 0.045 | 0.060 | 1.14 | 1.52 |
| R | 0.038 | 0.048 | 0.965 | 1.22 |

Dimensions — TO-263AA (N-Package) — D²-PAK Surface Mount

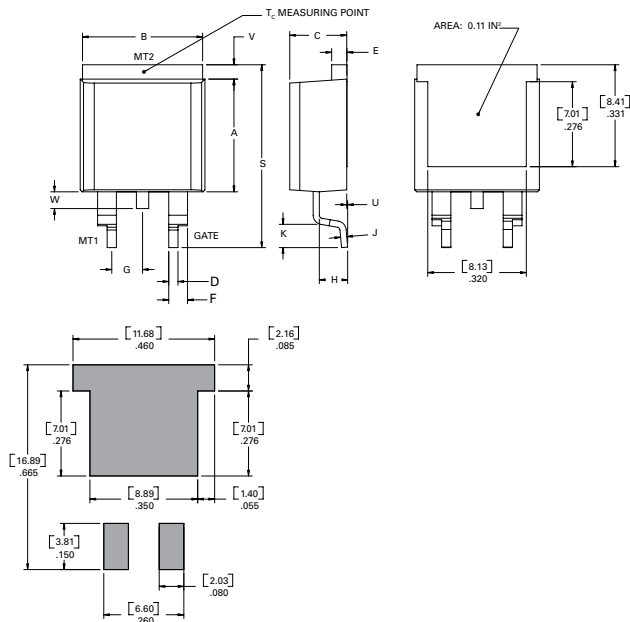

| Dimension | Inches | | Millimeters | |
|-----------|--------|-------|-------------|-------|
| | Min | Max | Min | Max |
| A | 0.360 | 0.370 | 9.14 | 9.40 |
| B | 0.380 | 0.420 | 9.65 | 10.67 |
| C | 0.178 | 0.188 | 4.52 | 4.78 |
| D | 0.025 | 0.035 | 0.64 | 0.89 |
| E | 0.045 | 0.060 | 1.14 | 1.52 |
| F | 0.060 | 0.075 | 1.52 | 1.91 |
| G | 0.095 | 0.105 | 2.41 | 2.67 |
| H | 0.092 | 0.102 | 2.34 | 2.59 |
| J | 0.018 | 0.024 | 0.46 | 0.61 |
| K | 0.090 | 0.110 | 2.29 | 2.79 |
| S | 0.590 | 0.625 | 14.99 | 15.88 |
| V | 0.035 | 0.045 | 0.89 | 1.14 |
| U | 0.002 | 0.010 | 0.05 | 0.25 |
| W | 0.040 | 0.070 | 1.016 | 1.78 |

Product Selector

| Part Number | Voltage (xx) | | | | Gate Sensitivity Quadrants | | Type | Package |
|-------------|--------------|------|------|-------|----------------------------|-------|-------------------|----------------------------|
| | 400V | 600V | 800V | 1000V | I – II – III | IV | | |
| Qxx10L4 | X | X | X | X | 25 mA | 50 mA | Standard Triac | TO-220L |
| Qxx10R4 | X | X | X | X | 25 mA | 50 mA | Standard Triac | TO-220R |
| Qxx10N4 | X | X | X | X | 25 mA | 50 mA | Standard Triac | TO-263 D ² -PAK |
| Qxx10L5 | X | X | X | X | 50 mA | | Standard Triac | TO-220L |
| Qxx10R5 | X | X | X | X | 50 mA | | Standard Triac | TO-220R |
| Qxx10N5 | X | X | X | X | 50 mA | | Standard Triac | TO-263 D ² -PAK |
| Qxx10LH5 | X | X | X | X | 50 mA | | Alternistor Triac | TO-220L |
| Qxx10RH5 | X | X | X | X | 50 mA | | Alternistor Triac | TO-220R |
| Qxx10NH5 | X | X | X | X | 50 mA | | Alternistor Triac | TO-263 D ² -PAK |

Packing Options

| Part Number | Marking | Weight | Packing Mode | Base Quantity |
|--------------|------------|--------|------------------|-------------------|
| Qxx10L/Ryy | Qxx10L/Ryy | 2.2 g | Bulk | 500 |
| Qxx10L/RyyTP | Qxx10L/Ryy | 2.2 g | Tube Pack | 500 (50 per tube) |
| Qxx10NyyTP | Qxx10Nyy | 1.6 g | Tube | 500 (50 per tube) |
| Qxx10NyyRP | Qxx10Nyy | 1.6 g | Embossed Carrier | 500 |

Note: xx = voltage, yy = type & sensitivity

TO-263 Embossed Carrier Reel Pack (RP) Specifications

Meets all EIA-481-2 Standards

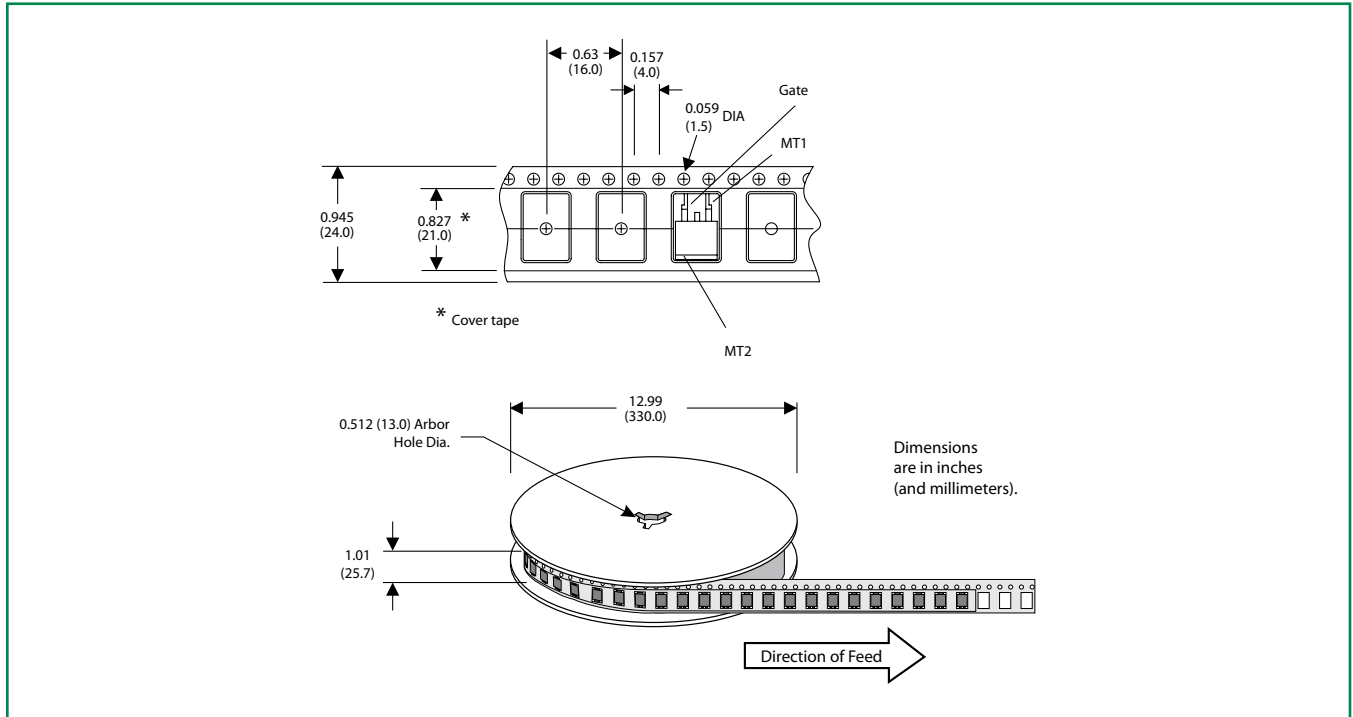

Part Numbering System

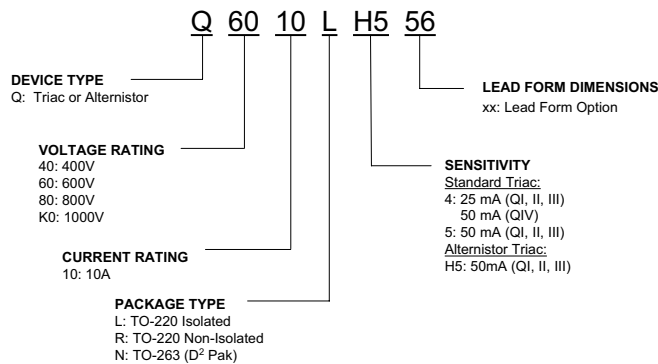

Part Marking System

TO-220 AB – (R Package)
TO-263 AB – (N Package)



TO-220 AB – (L Package)

Компания «Life Electronics» занимается поставками электронных компонентов импортного и отечественного производства от производителей и со складов крупных дистрибьюторов Европы, Америки и Азии.

С конца 2013 года компания активно расширяет линейку поставок компонентов по направлению коаксиальный кабель, кварцевые генераторы и конденсаторы (керамические, пленочные, электролитические), за счёт заключения дистрибьюторских договоров

Мы предлагаем:

- Конкурентоспособные цены и скидки постоянным клиентам.
- Специальные условия для постоянных клиентов.
- Подбор аналогов.
- Поставку компонентов в любых объемах, удовлетворяющих вашим потребностям.
- Приемлемые сроки поставки, возможна ускоренная поставка.
- Доставку товара в любую точку России и стран СНГ.
- Комплексную поставку.
- Работу по проектам и поставку образцов.
- Формирование склада под заказчика.
- Сертификаты соответствия на поставляемую продукцию (по желанию клиента).
- Тестирование поставляемой продукции.
- Поставку компонентов, требующих военную и космическую приемку.
- Входной контроль качества.
- Наличие сертификата ISO.

В составе нашей компании организован Конструкторский отдел, призванный помогать разработчикам, и инженерам.

Конструкторский отдел помогает осуществить:

- Регистрацию проекта у производителя компонентов.
- Техническую поддержку проекта.
- Защиту от снятия компонента с производства.
- Оценку стоимости проекта по компонентам.
- Изготовление тестовой платы монтаж и пусконаладочные работы.



Тел: +7 (812) 336 43 04 (многоканальный)

Email: org@lifeelectronics.ru